



HAL
open science

Advancements of γ -ray spectroscopy of isotopically identified fission fragments with AGATA and VAMOS++

J. Dudouet, A. Lemasson, M. Rejmund

► **To cite this version:**

J. Dudouet, A. Lemasson, M. Rejmund. Advancements of γ -ray spectroscopy of isotopically identified fission fragments with AGATA and VAMOS++. 17Th International Symposium on Capture Gamma-Ray Spectroscopy and Related Topics - CGS17, Jul 2023, Grenoble, France. in2p3-04908330

HAL Id: in2p3-04908330

<https://in2p3.hal.science/in2p3-04908330v1>

Submitted on 23 Jan 2025

HAL is a multi-disciplinary open access archive for the deposit and dissemination of scientific research documents, whether they are published or not. The documents may come from teaching and research institutions in France or abroad, or from public or private research centers.

L'archive ouverte pluridisciplinaire **HAL**, est destinée au dépôt et à la diffusion de documents scientifiques de niveau recherche, publiés ou non, émanant des établissements d'enseignement et de recherche français ou étrangers, des laboratoires publics ou privés.



Advancements of γ -ray spectroscopy of isotopically identified fission fragments with AGATA and VAMOS++

Jérémie Dudouet

on behalf of the AGATA/VAMOS collaborations

Institut de Physique des deux infinis de Lyon (IP2I)

17th International Symposium on Capture Gamma-Ray Spectroscopy and Related Topics

➔ The presented work is part of the recently published **AGATA Topical Issue in EPJA**:
 ➔ List of articles covering the different AGATA facets (physics, detectors, electronics, softwares...)



EPJ A 2021 Impact factor **3.131**

Hadrons and Nuclei

10 most recent Browse issues Topical issues Reviews Letters

The European Physical Journal A
AGATA: Advancements in Science and Technology

Nicolas Alamanos, Maria Jose Garcia Borge, Angela Bracco, Emmanuel Clement, Andres Gadea, Wolfram Korten, Silvia Leoni and John Simpson

Eur. Phys. J. A (2023) 59:134
<https://doi.org/10.1140/epja/s10050-023-01053-0>

THE EUROPEAN
 PHYSICAL JOURNAL A



Regular Article - Experimental Physics

Advancements of γ -ray spectroscopy of isotopically identified fission fragments with AGATA and VAMOS++

A. Lemasson^{1,a}, J. Dudouet², M. Rejmund¹, J. Ljungvall³, A. G3rgen⁴, W. Korten⁵

¹ GANIL, CEA/DRF-CNRS/IN2P3, Bd Henri Becquerel, BP 55027, 14076 Caen Cedex 5, France

² Universit3 de Lyon 1, CNRS/IN2P3, UMR5822, IP2I, 69622 Villeurbanne Cedex, France

³ IJCLab, Universit3 Paris-Saclay, CNRS/IN2P3, 91405 Orsay, France

⁴ Department of Physics, University of Oslo, Blindern, PO Box 1048, 0316 Oslo, Norway

⁵ IRFU, CEA, Universit3 Paris-Saclay, 91191 Gif-sur-Yvette, France

Received: 8 March 2023 / Accepted: 6 June 2023

© The Author(s), under exclusive licence to Societ3 Italiana di Fisica and Springer-Verlag GmbH Germany, part of Springer Nature 2023

Communicated by Nicolas Alamanos

The nuclear fission process

- ➔ Powerful and efficient way to produce neutron rich nuclei
- ➔ Covering a wide range of key nuclei in the nuclear structure understanding

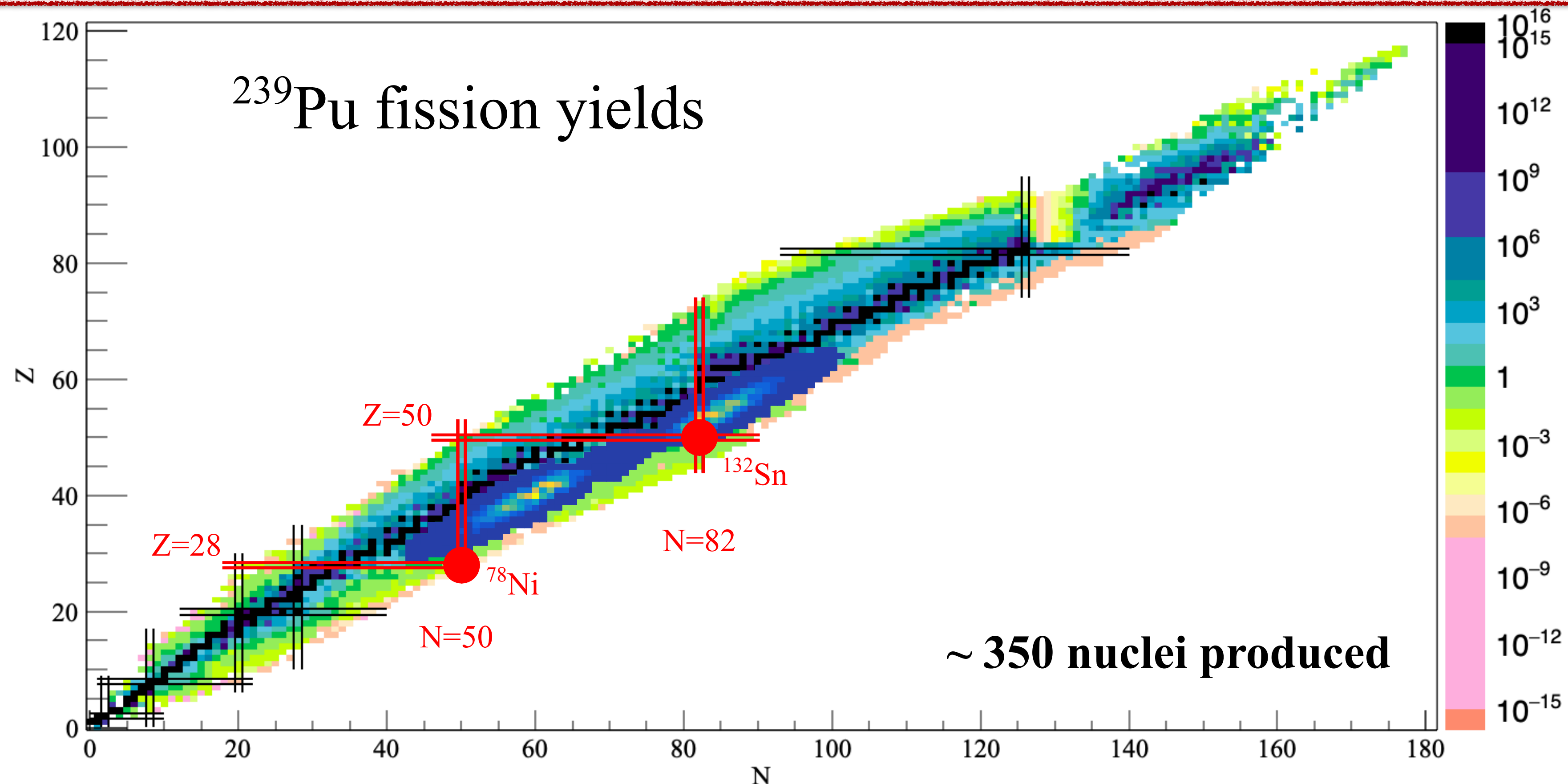

Nuclear fission fragments spectroscopy

→ Two schools: **High fold studies** / **fission fragments identification**

GAMMASPHERE

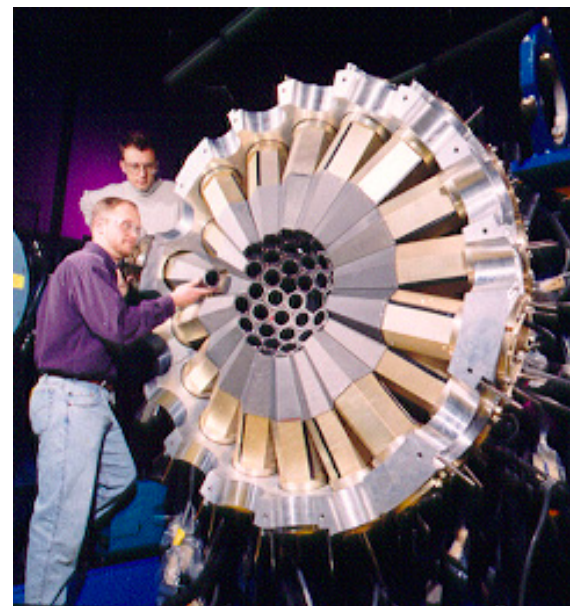

EUROGAM II

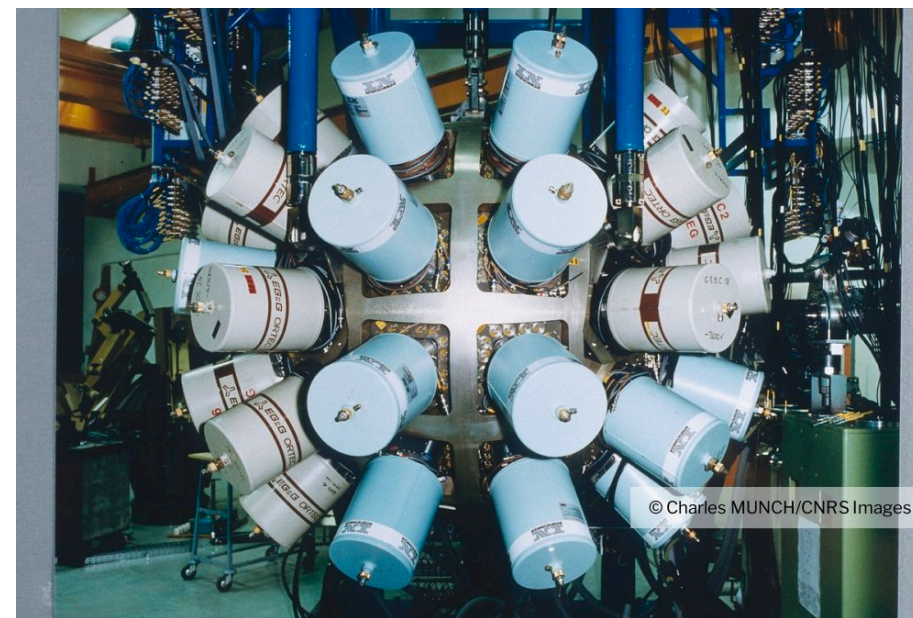

NUBALL

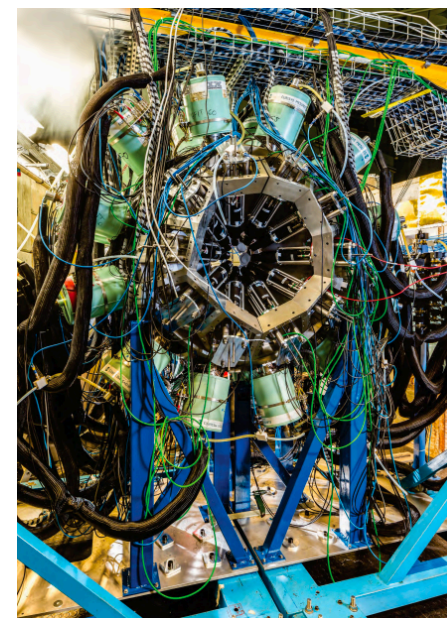

PRISMA/CLARA

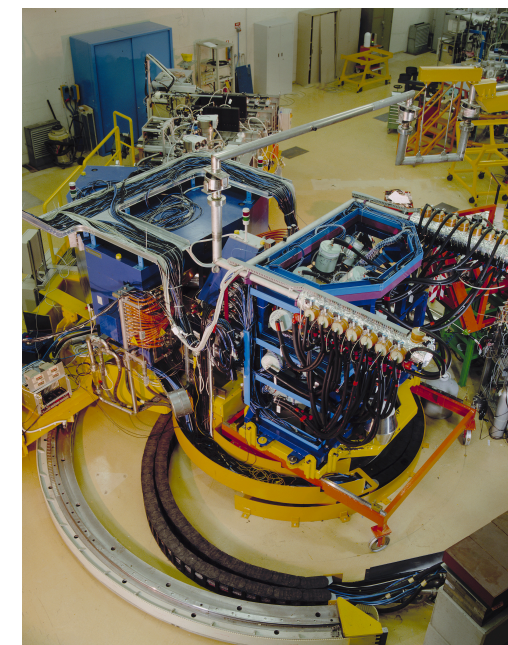

PRISMA/AGATA

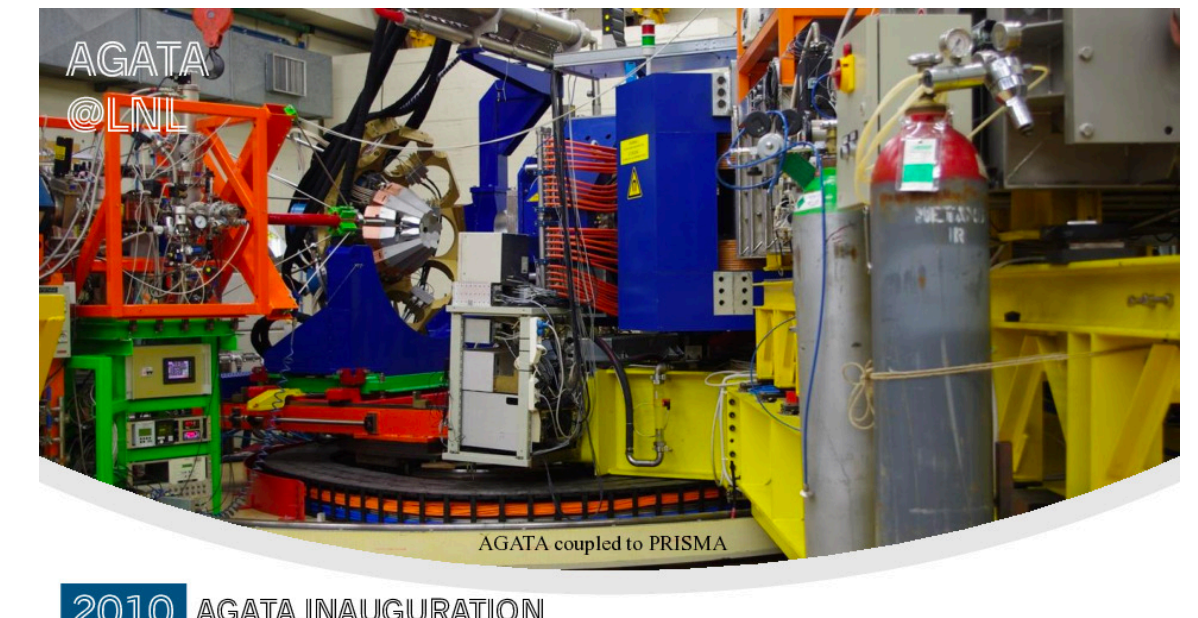

EUROBALL IV

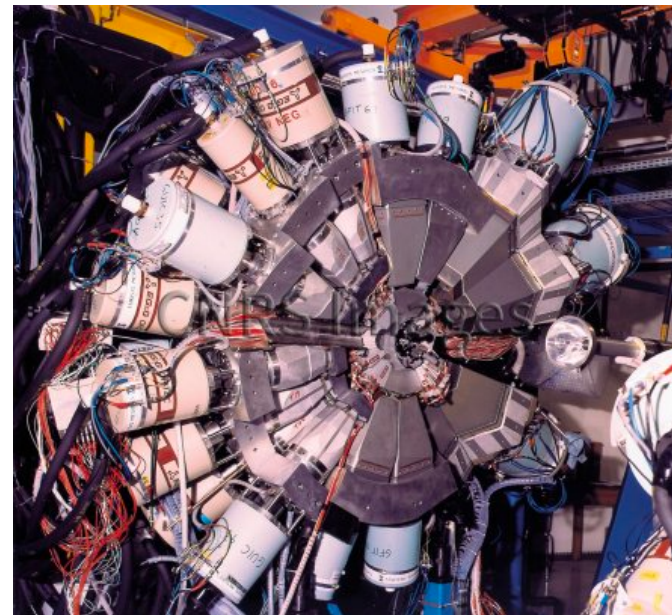

FIPPS

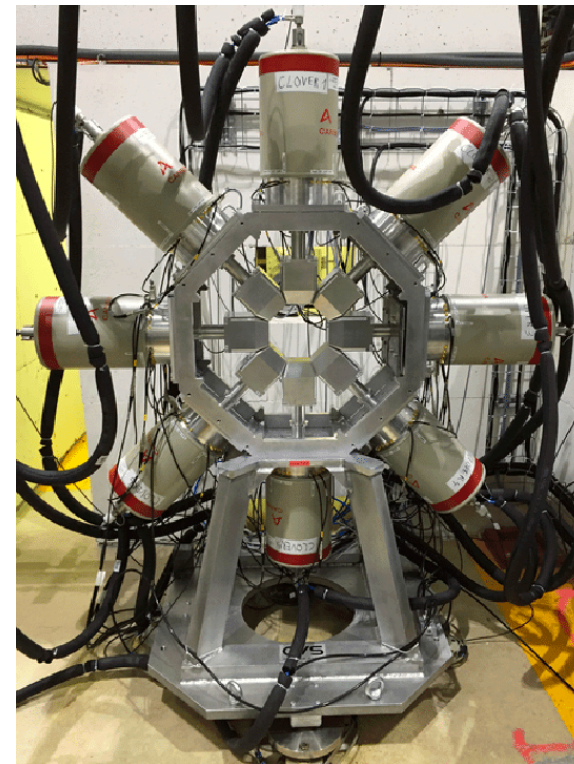

EXOGAM

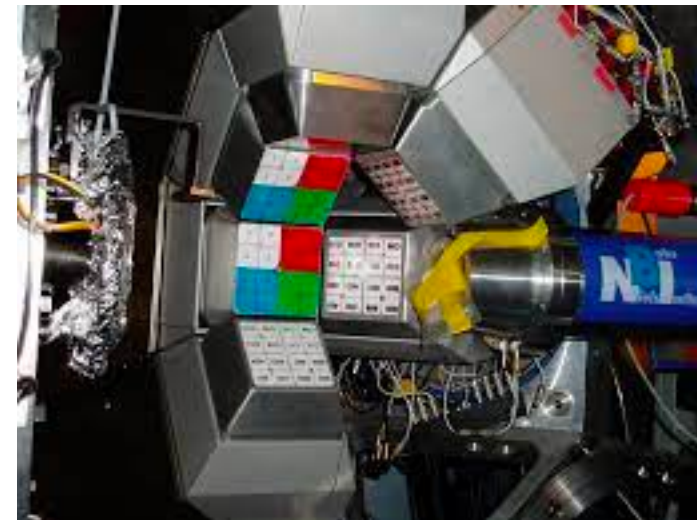

VAMOS/EXOGAM



VAMOS++/AGATA

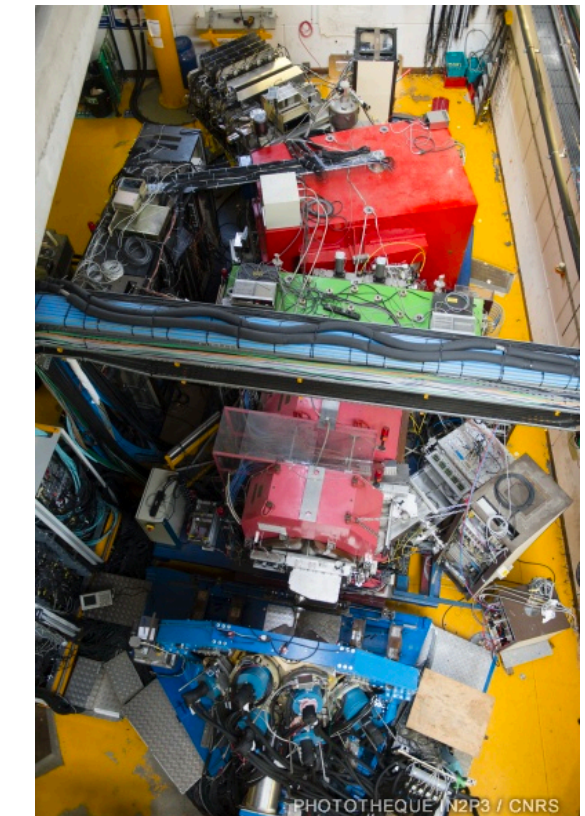

Nuclear fission fragments spectroscopy

➔ Two schools: **High fold studies / fission fragments identification**

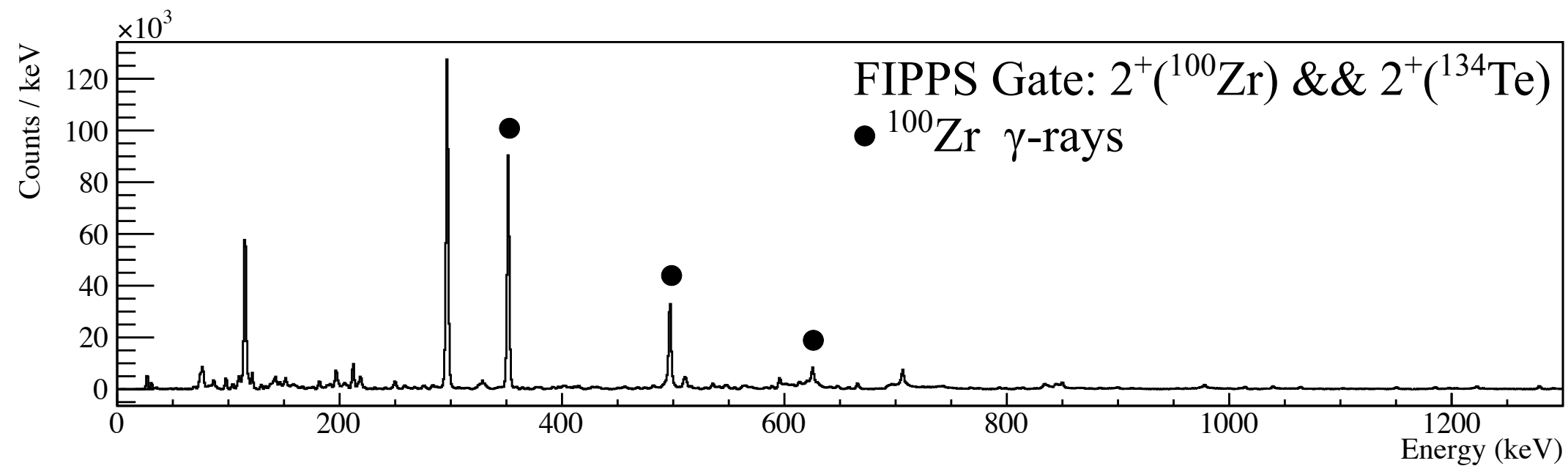
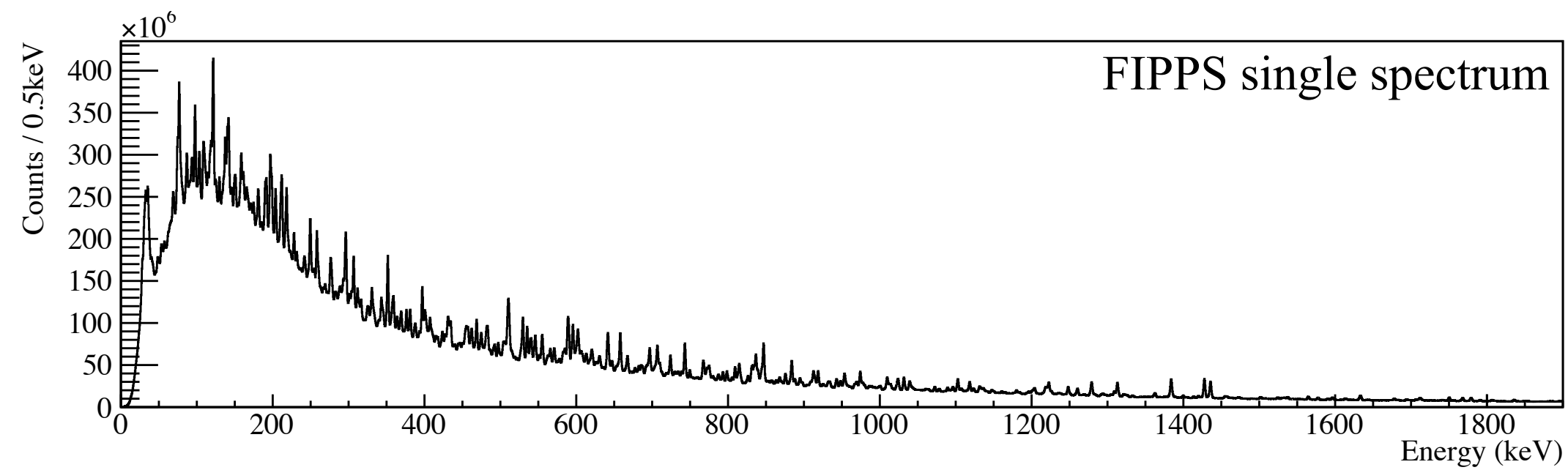

- Lot of statistics available with high folds (fold ≥ 3)
- Require a minimal knowledge of the nucleus
- Complicated analysis to avoid bad γ -ray attribution

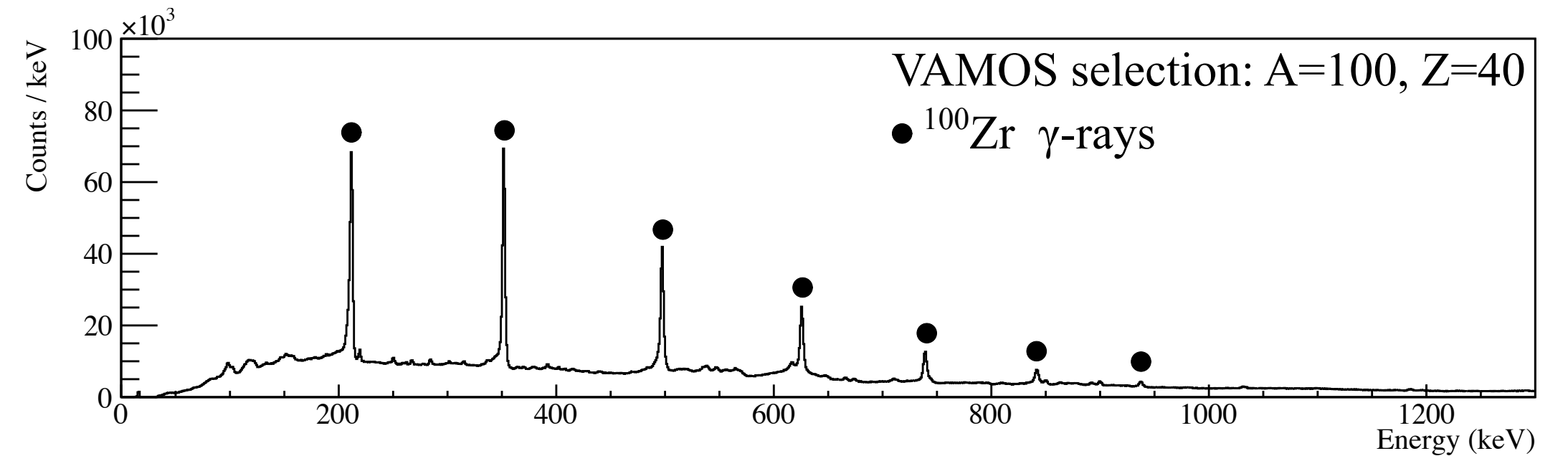
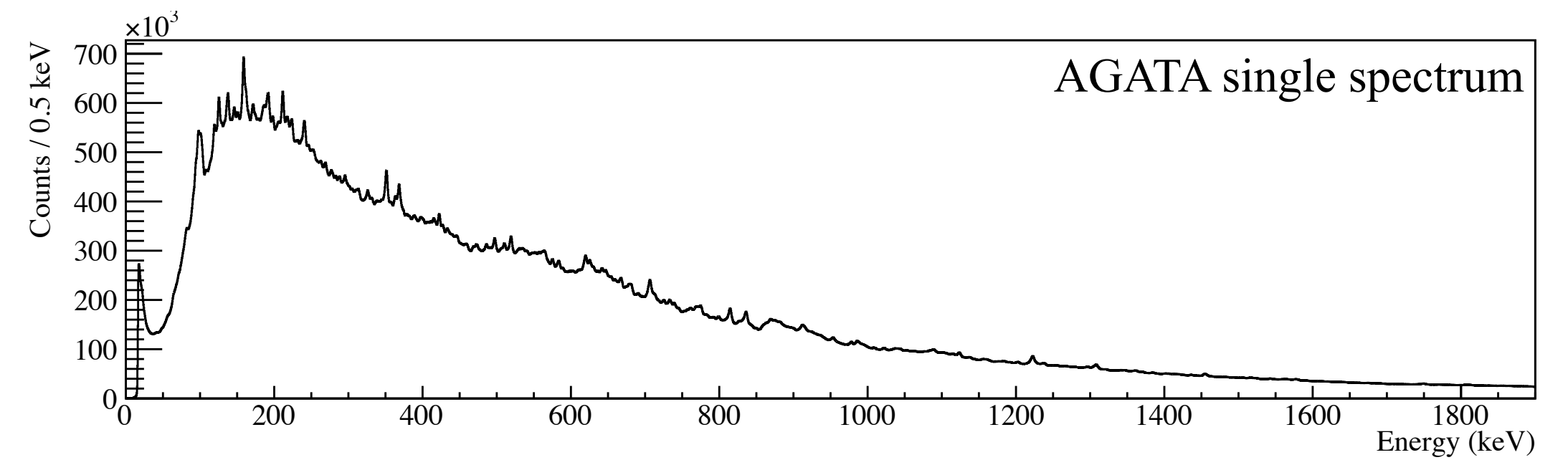

- Experimental setup much more complicated
- No statistics for fold ≥ 2 (γ - γ analysis only)
- Can be used on unknown nuclei
- Much simpler analysis

The VAMOS++ spectrometer

- ➔ Beam: ^{238}U @ 6.2 MeV/u, $I \sim 30 \text{ enA}$
- ➔ Target: ^9Be $\sim 10 \mu\text{m}$
- ➔ Detection angle: $19^\circ < \theta < 28^\circ$
- ➔ Recoil velocities: $\beta \sim 0.1$
- ➔ Validation rate: $\sim 1.5 \text{ kHz}$

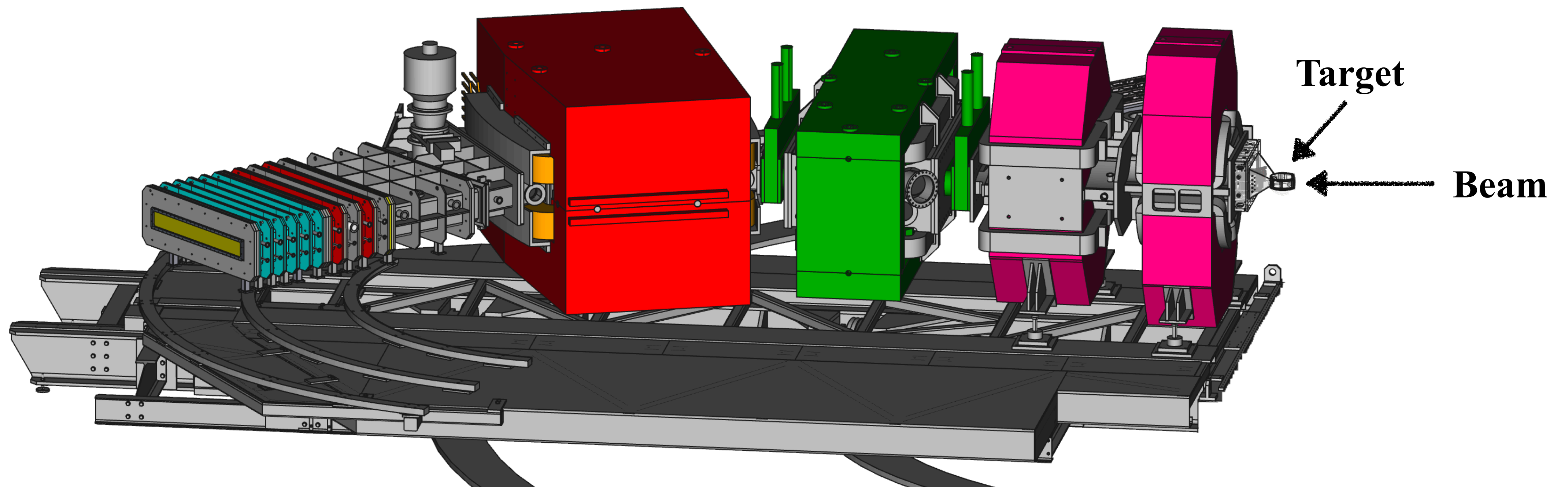

The VAMOS++ spectrometer: Mass identification

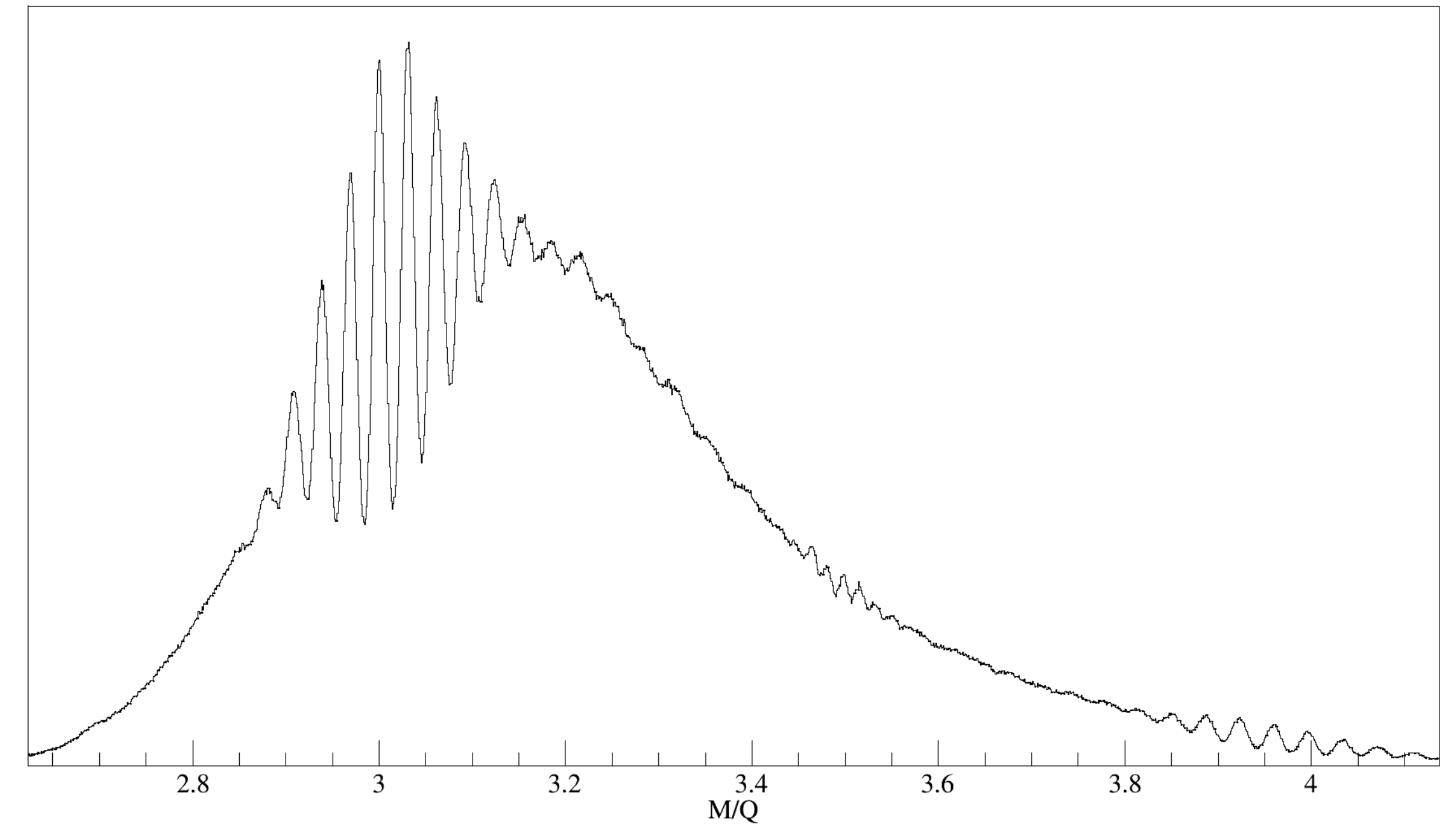
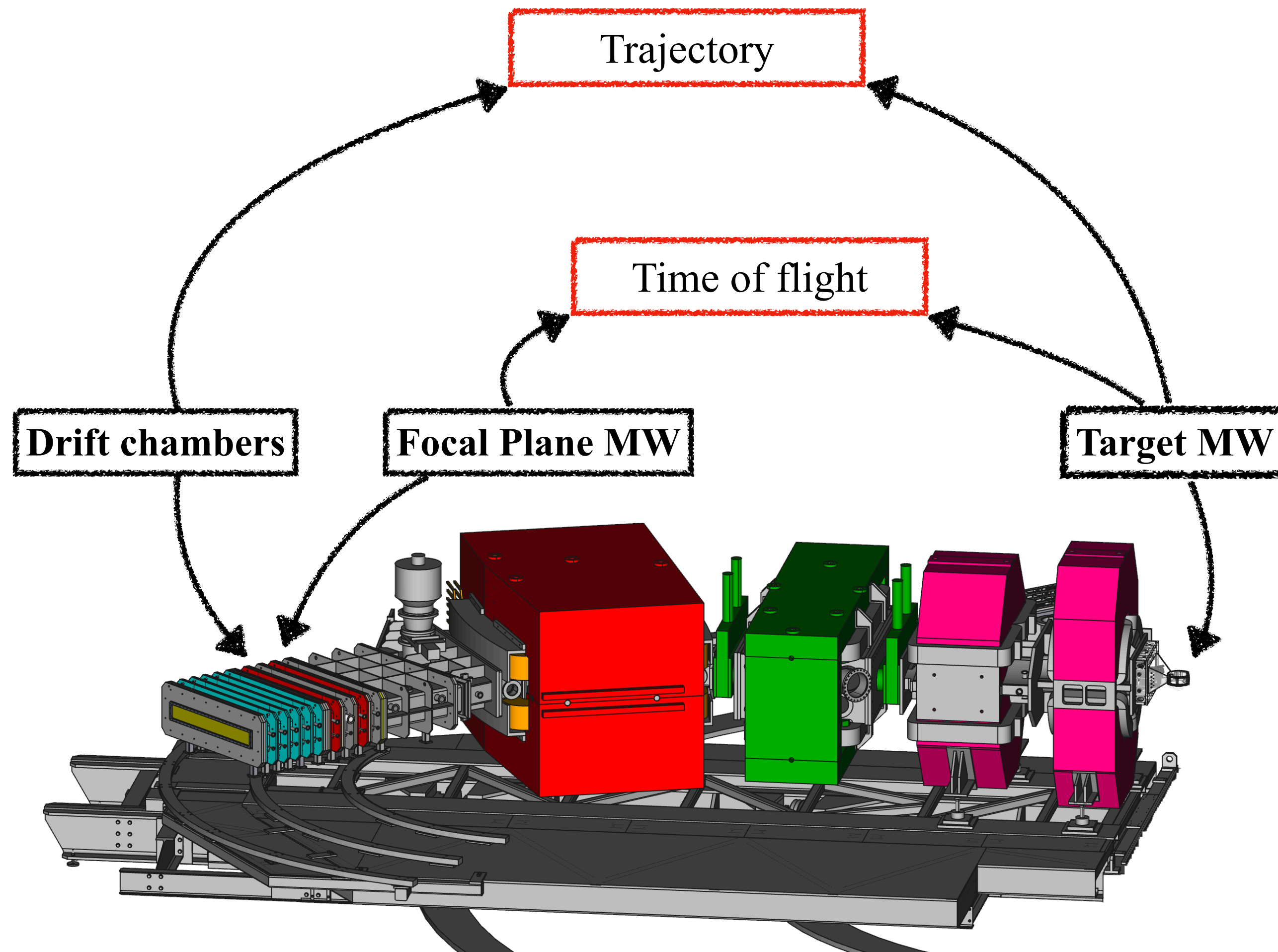

$$\frac{M}{Q} = \frac{B\rho}{3.105 \times \beta}$$

The VAMOS++ spectrometer: Mass identification

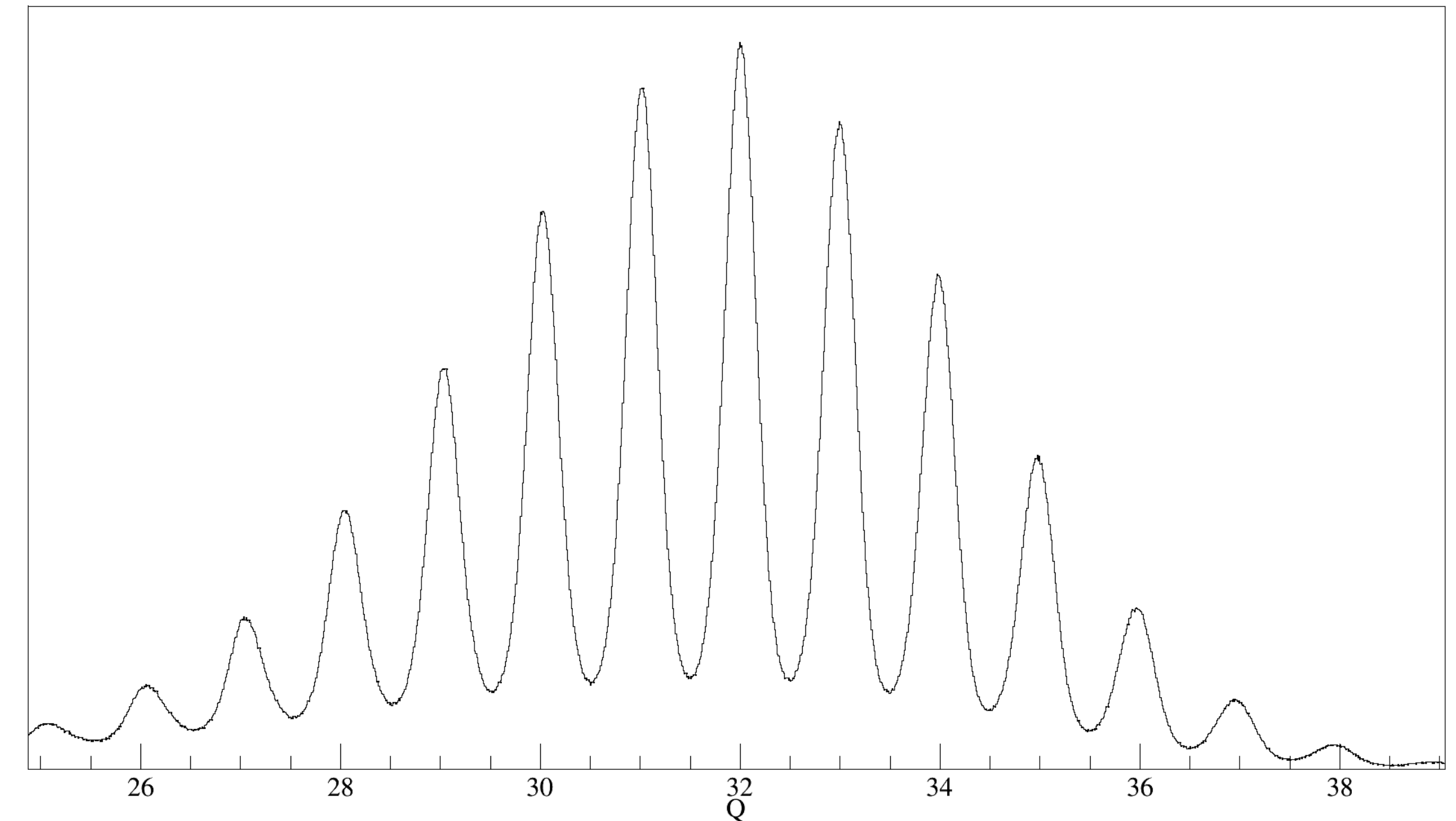
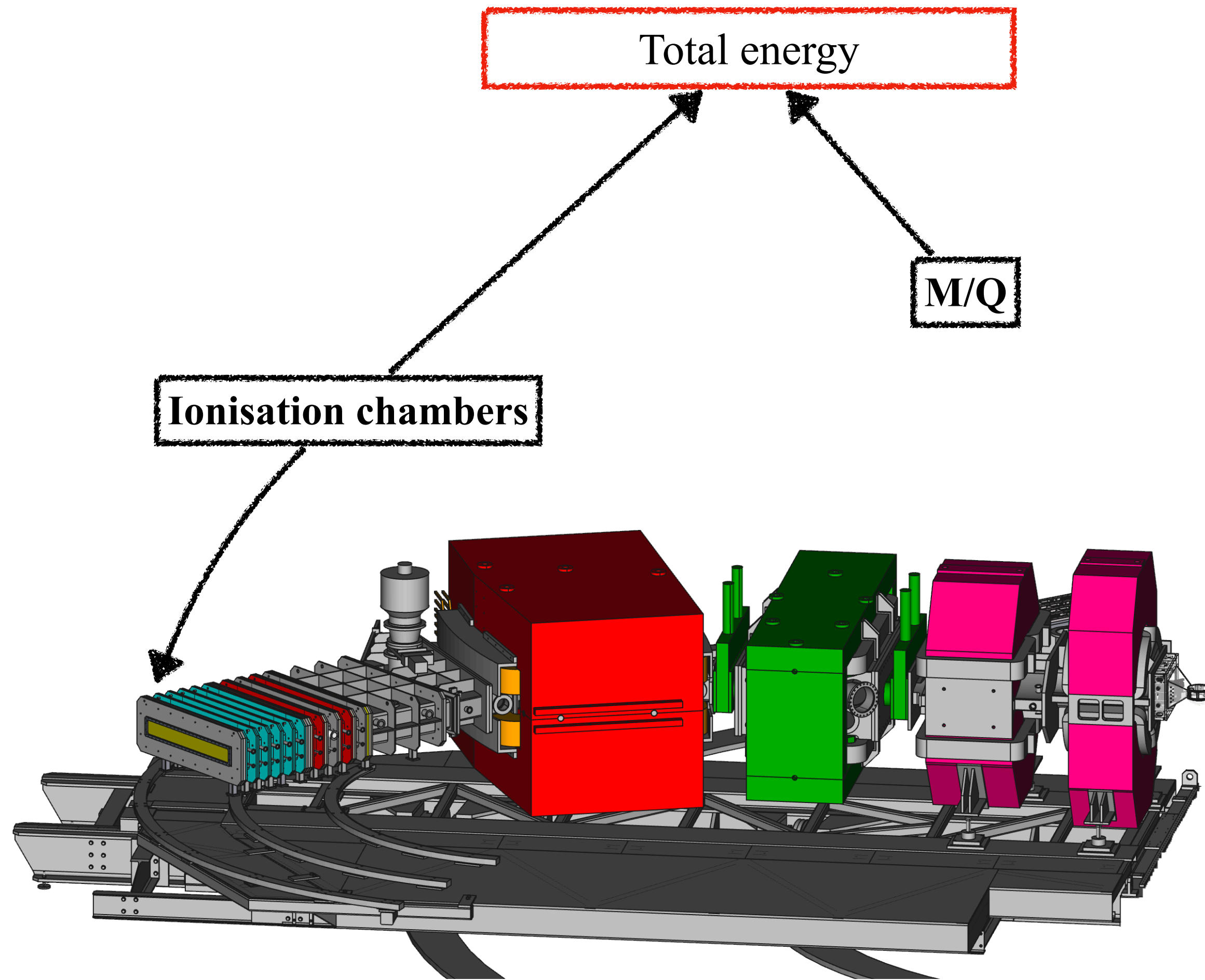

$$Q = \frac{2 \times E_{tot}}{931.5 \times \beta^2} \times \frac{Q}{M}$$

The VAMOS++ spectrometer: Mass identification

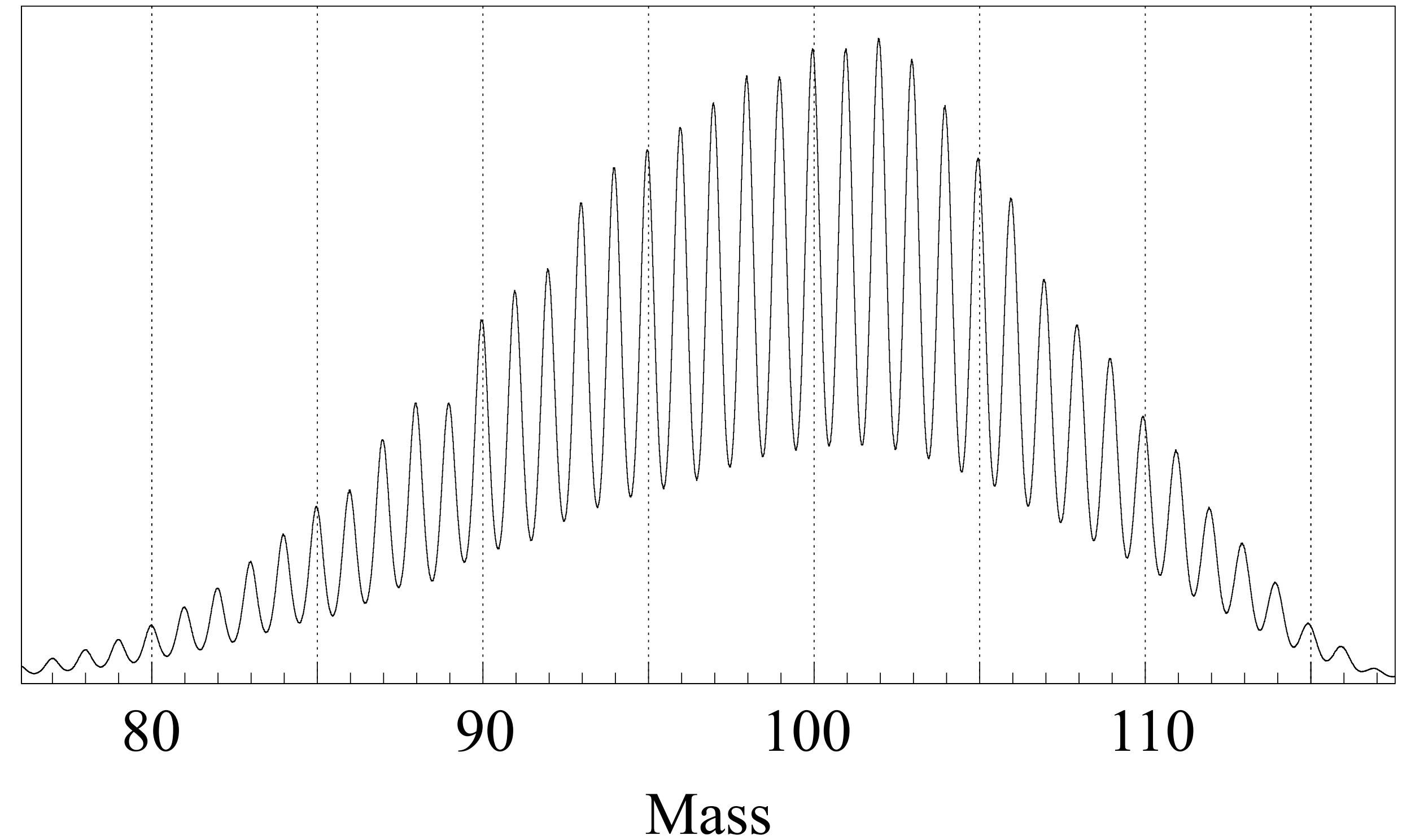
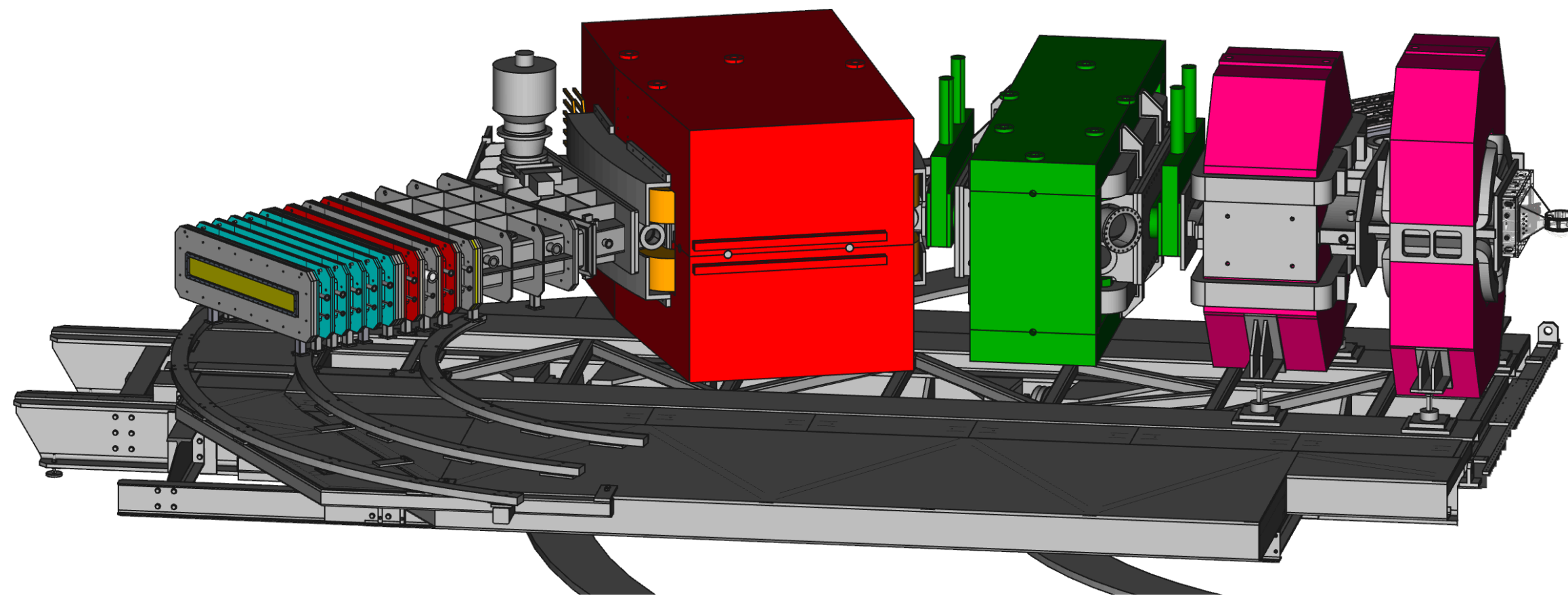
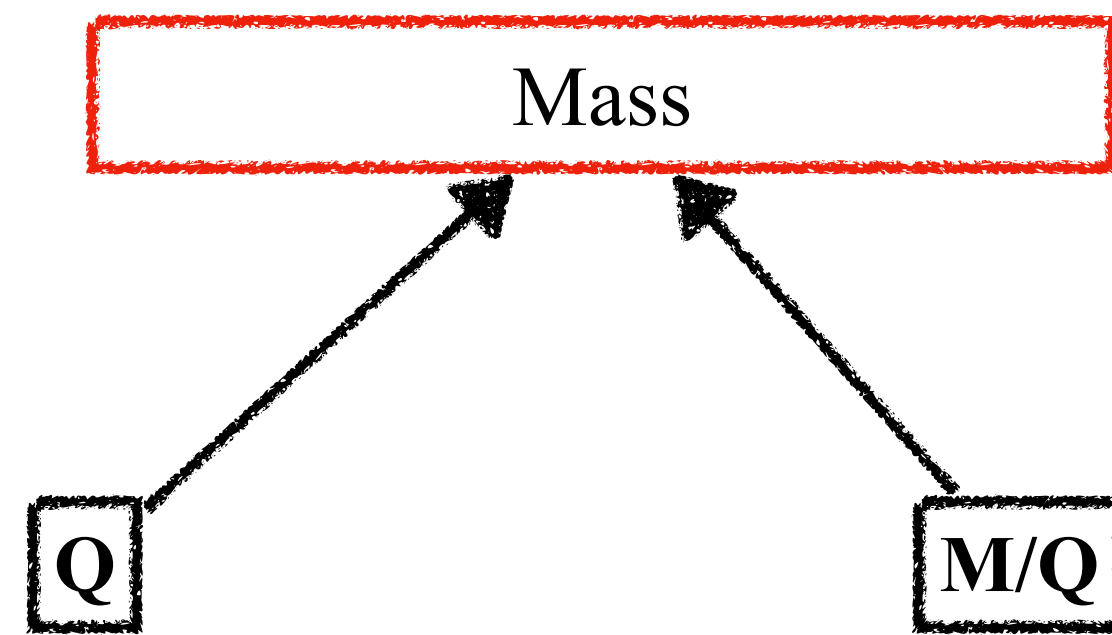

$$\frac{\Delta M}{M} \sim 0.6\%$$

The VAMOS++ spectrometer: Z identification

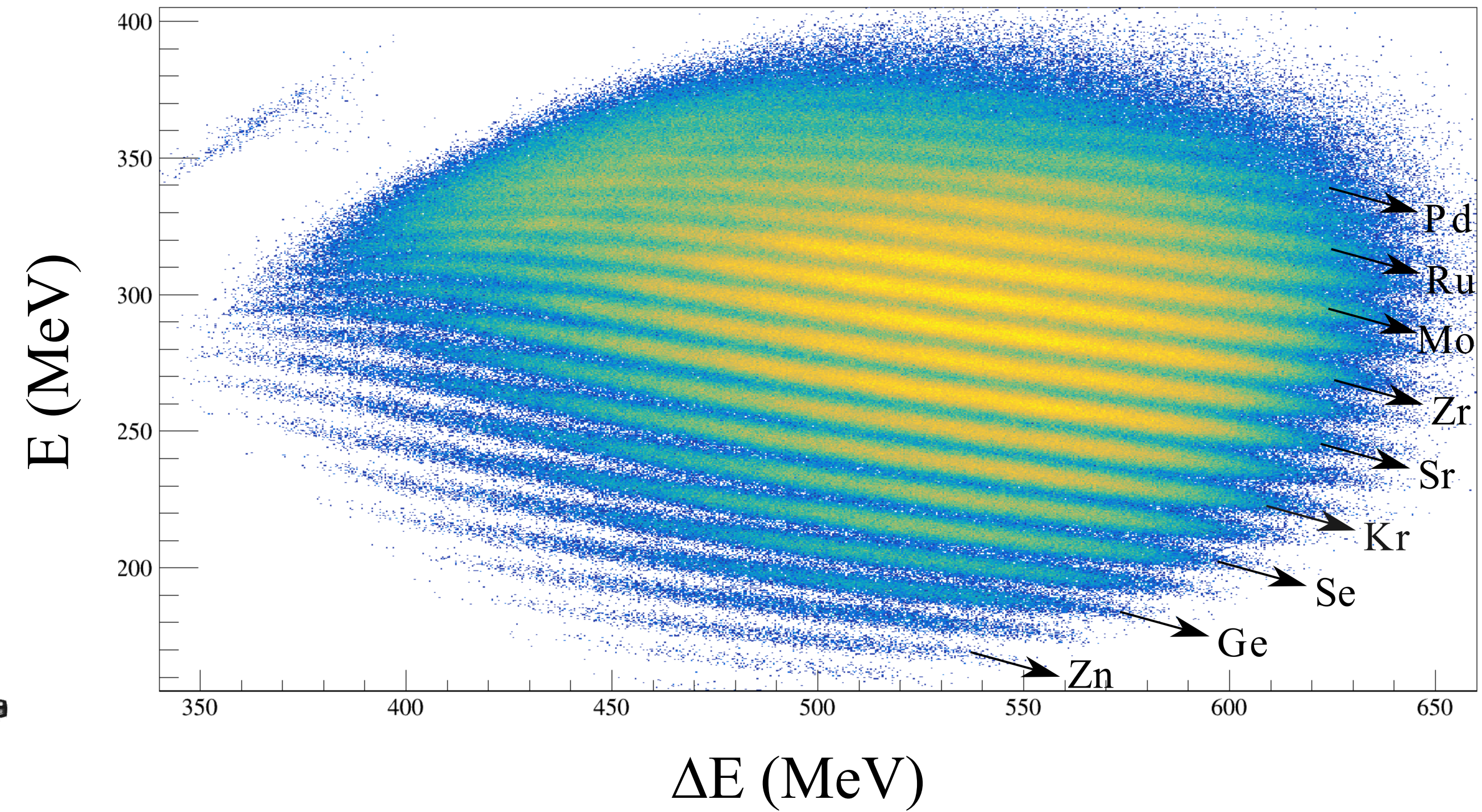
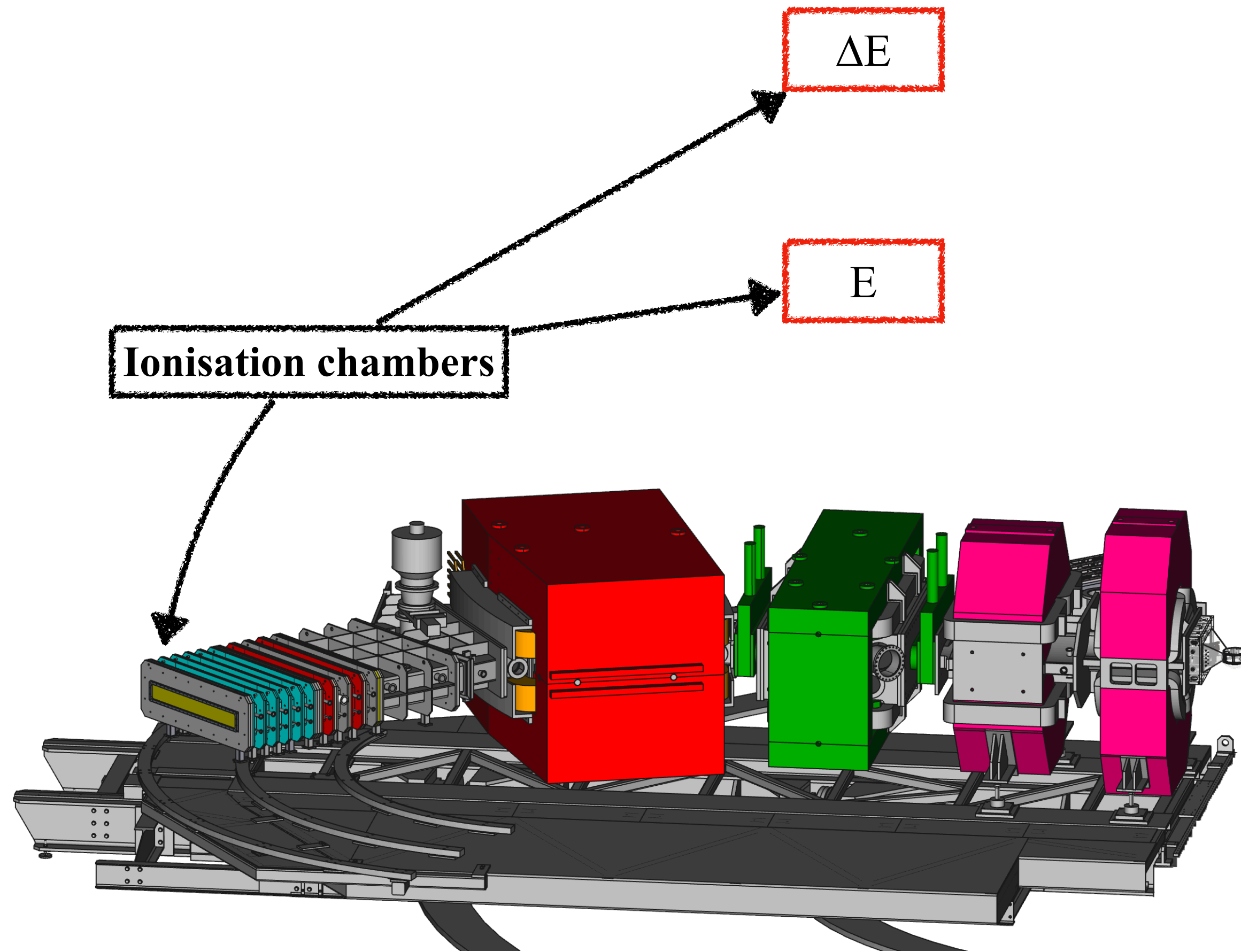

The VAMOS++ spectrometer: Z identification

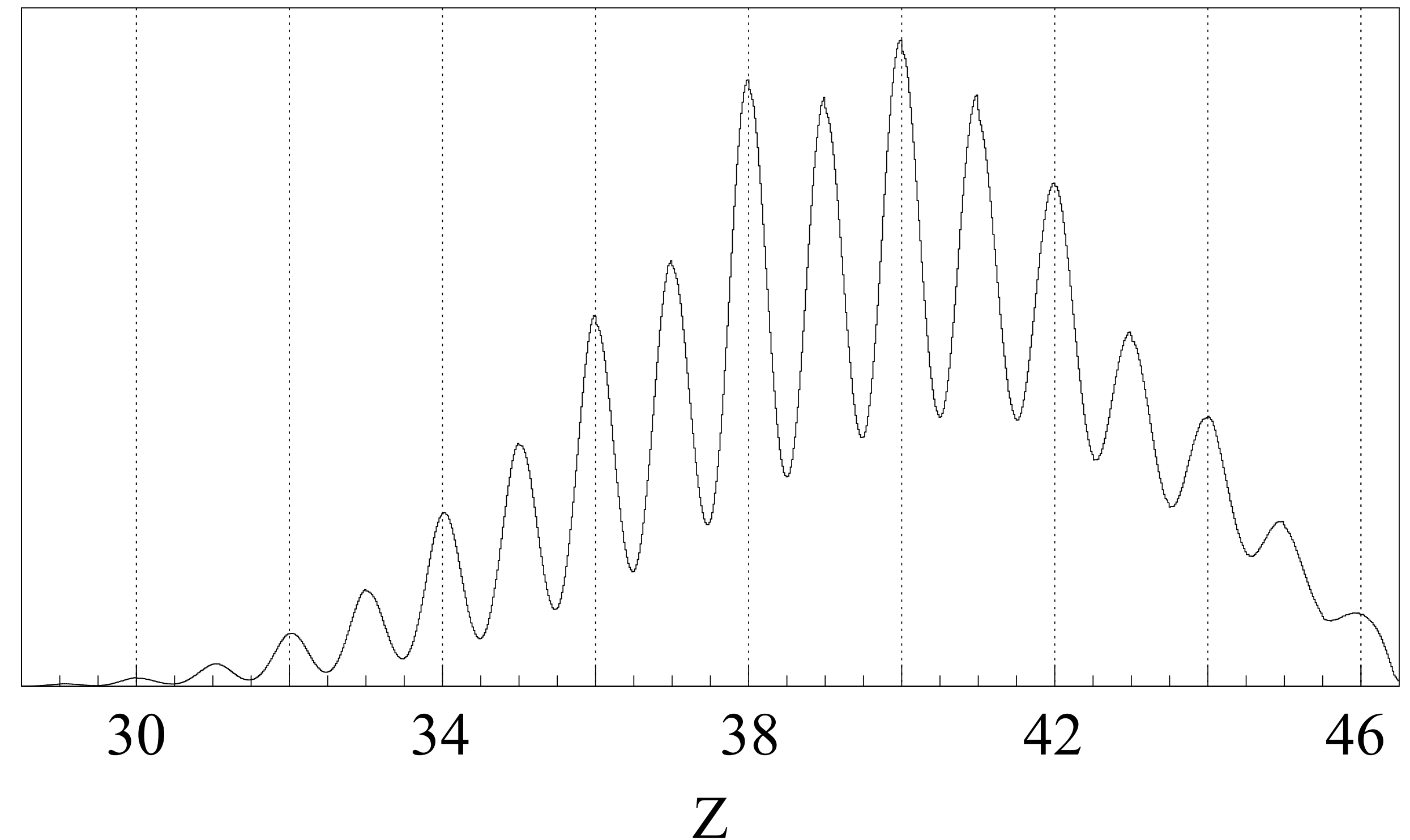
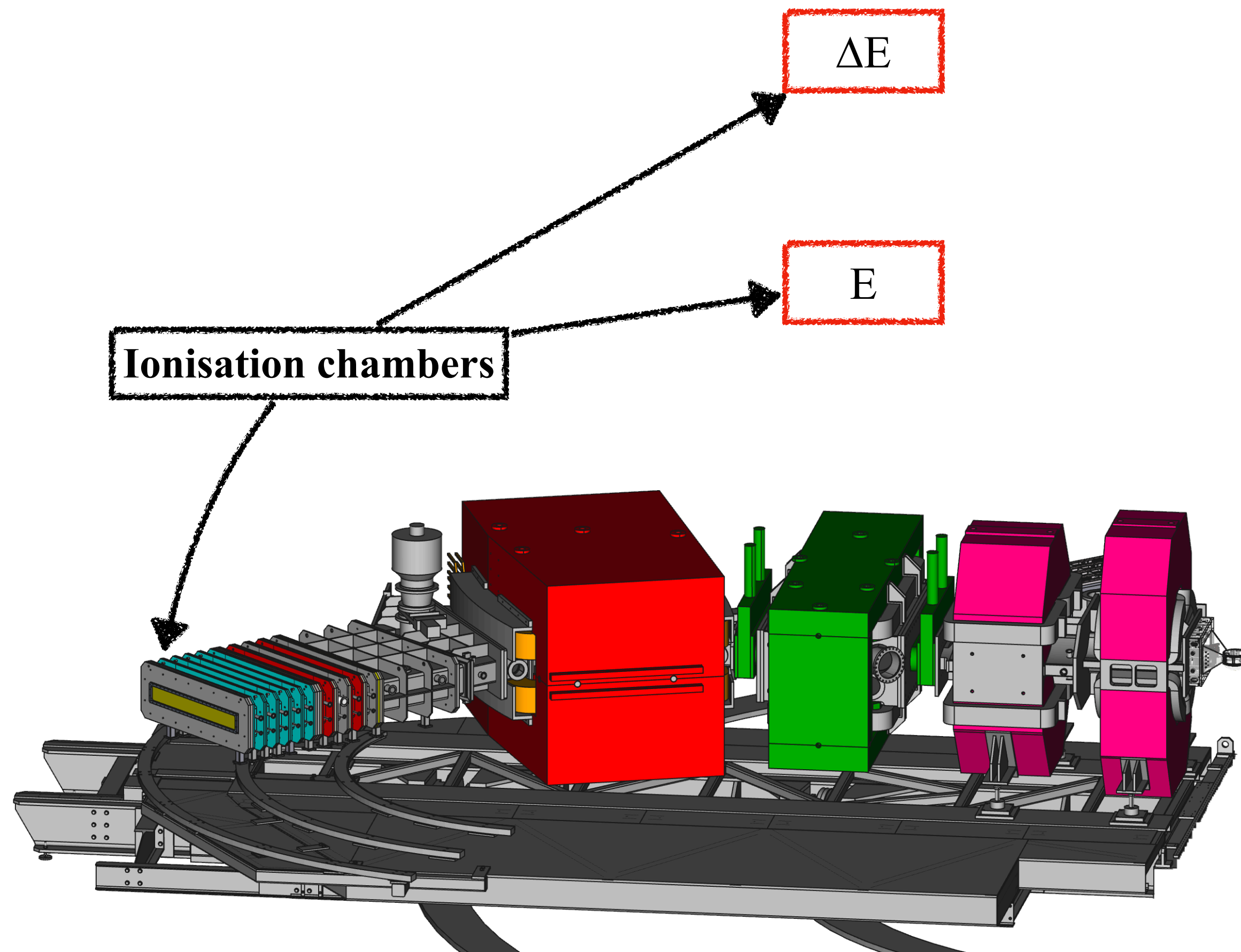

$$\frac{\Delta Z}{Z} \sim 1.5\%$$

The VAMOS++ spectrometer

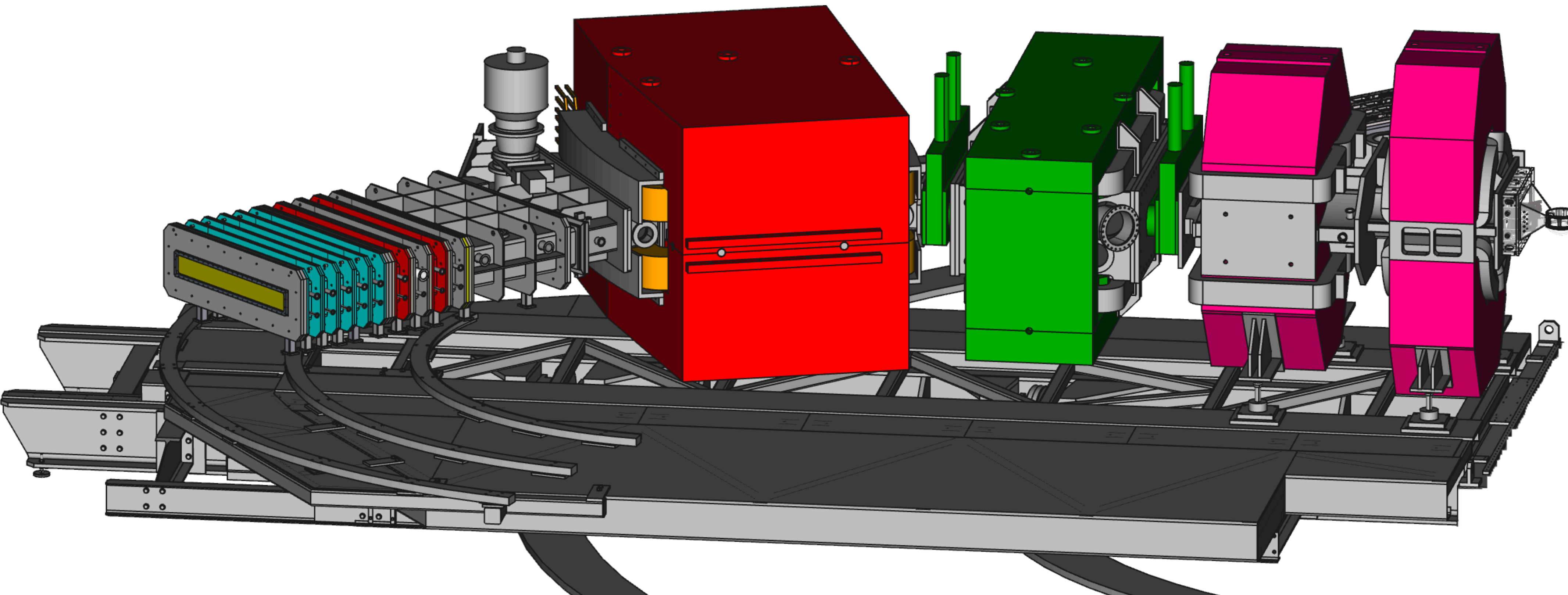

The AGATA Gamma Tracking Array

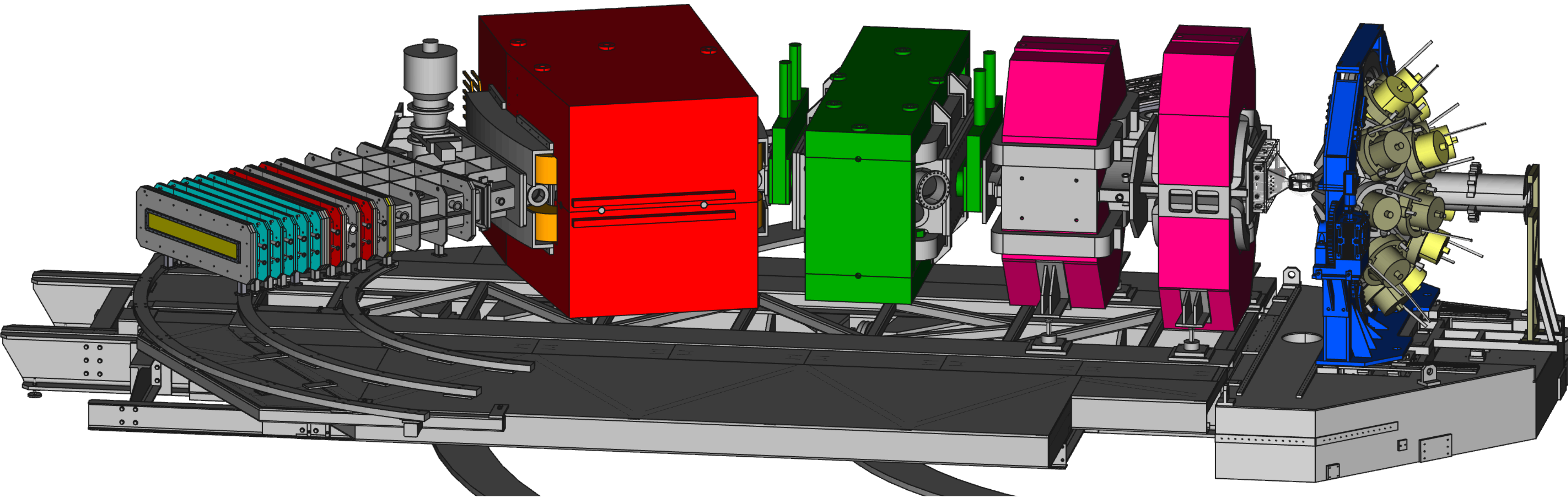

The AGATA Gamma Tracking Array

- ➔ Continuous sphere of segmented HPGe crystals
 - ➔ High energy resolution
 - ➔ High efficiency
- ➔ Full digital electronic:
 - ➔ High counting rates capabilities
 - ➔ Position resolution of interaction points ~ 5 mm
- ➔ Tracking of the γ -ray path in the crystals
 - ➔ Increased peak to background ratio
 - ➔ Very precise Doppler Correction

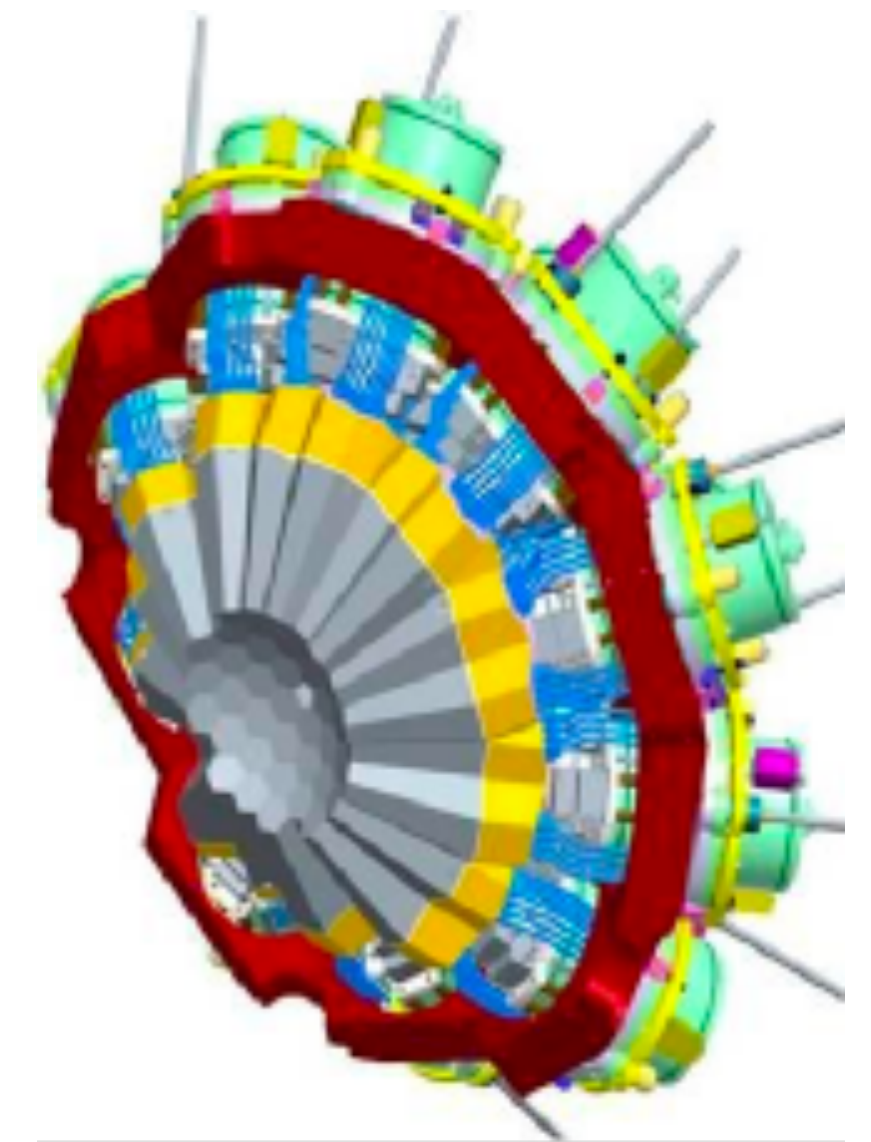
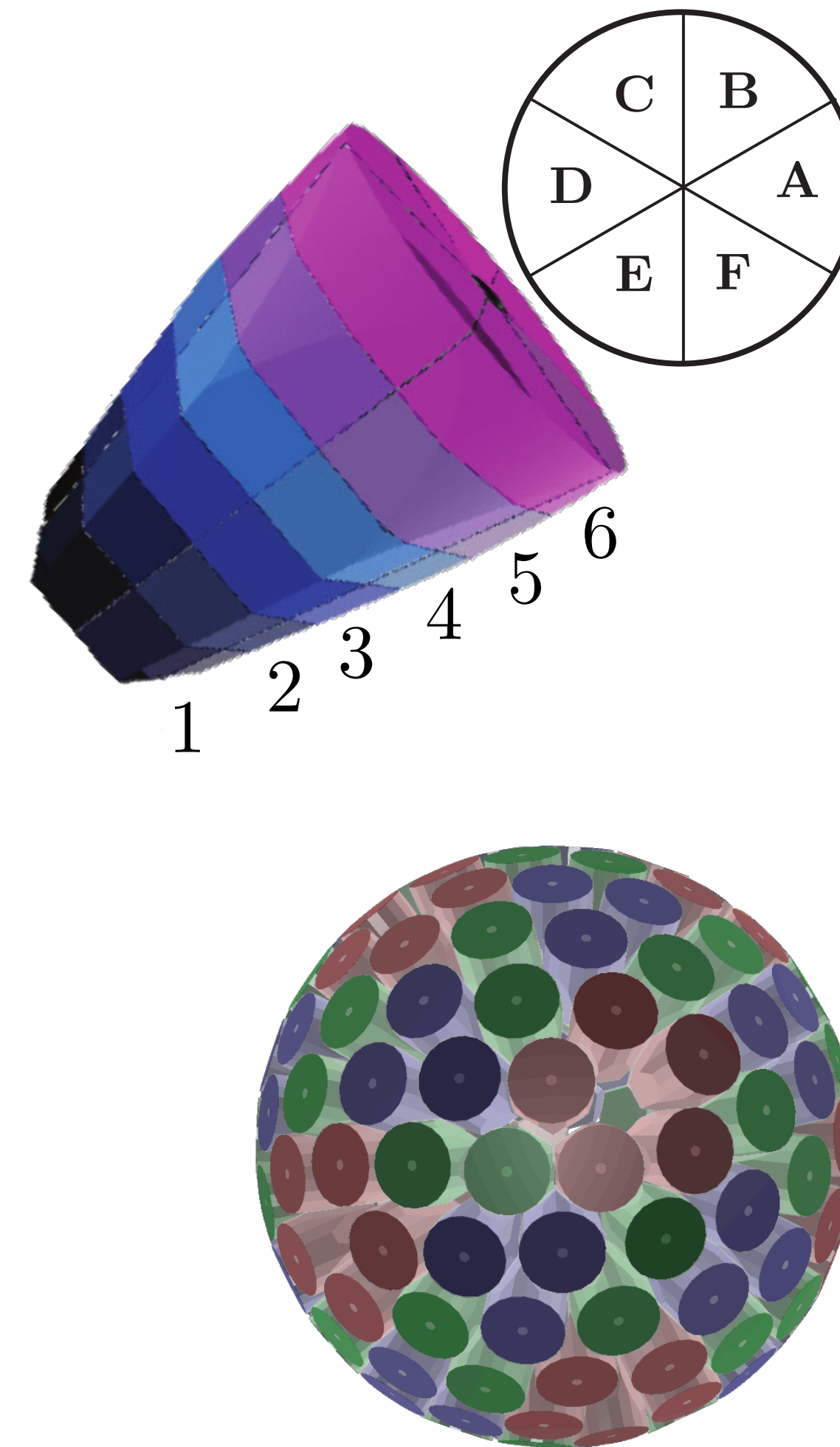

The AGATA Gamma Tracking Array

- ➔ Continuous sphere of segmented HGPe crystals
 - ➔ High energy resolution
 - ➔ High efficiency
- ➔ Full digital electronic:
 - ➔ High counting rates capabilities
 - ➔ Position resolution of interaction points ~ 5 mm
- ➔ Tracking of the γ -ray path in the crystals
 - ➔ Increased peak to background ratio
 - ➔ Very precise Doppler Correction

The Pulse Shape Analysis method (PSA)

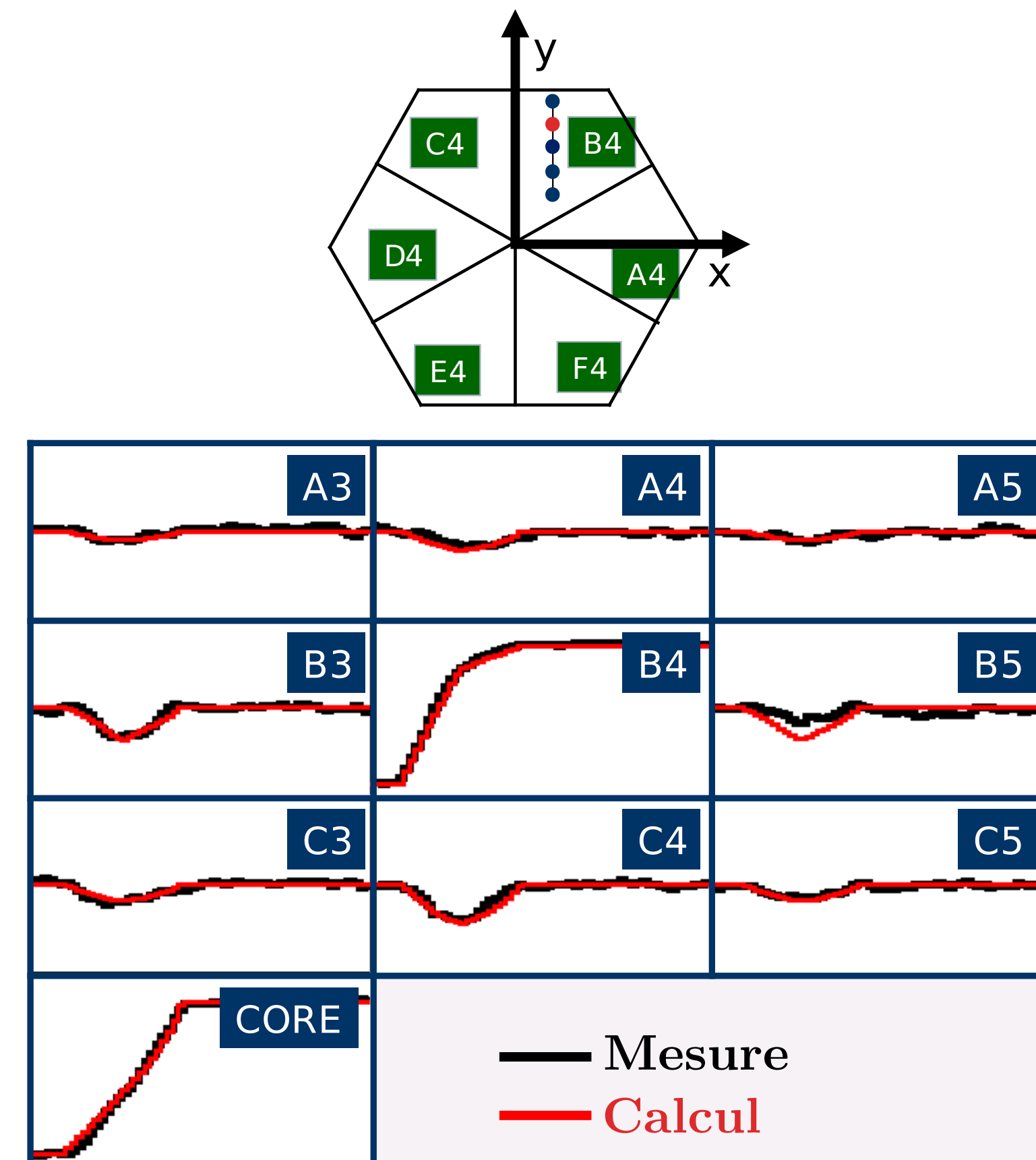

The AGATA Gamma Tracking Array

- ➔ Continuous sphere of segmented HGPe crystals
 - ➔ High energy resolution
 - ➔ High efficiency
- ➔ Full digital electronic:
 - ➔ High counting rates capabilities
 - ➔ Position resolution of interaction points $\sim 5\text{mm}$
- ➔ Tracking of the γ -ray path in the crystals
 - ➔ Increased peak to background ratio
 - ➔ Very precise Doppler Correction

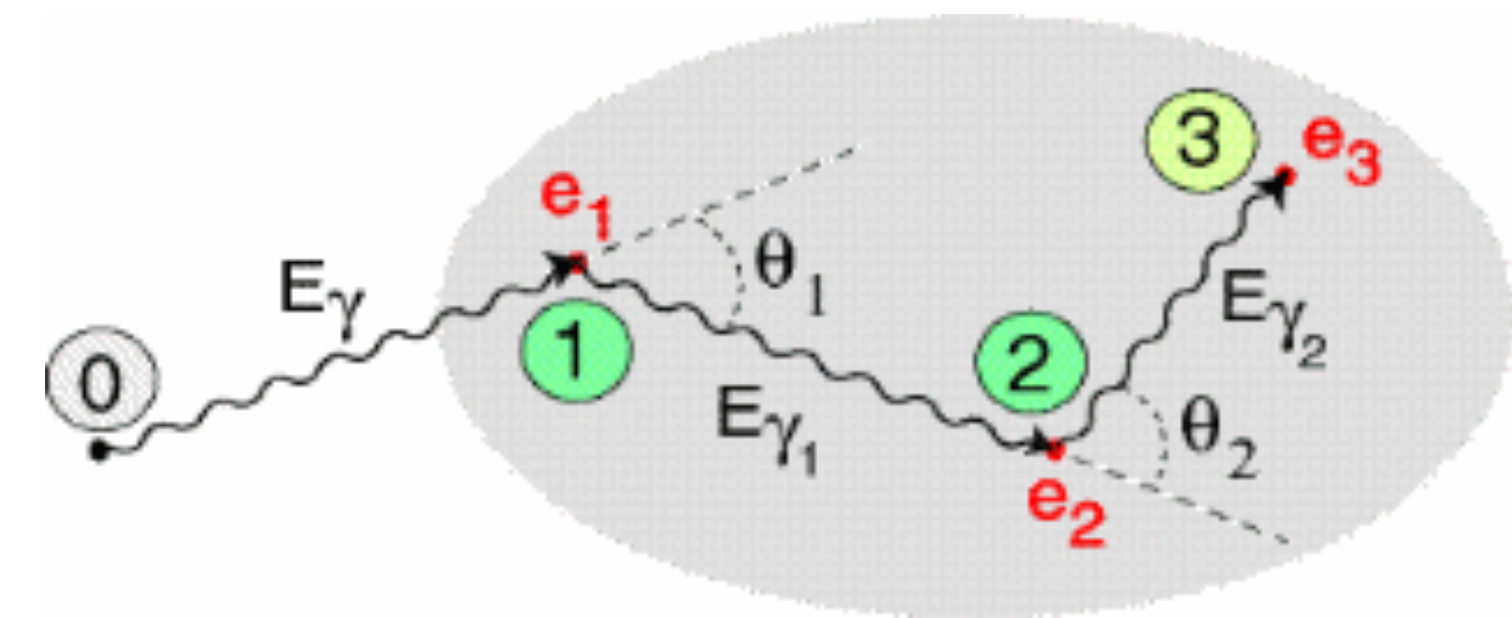
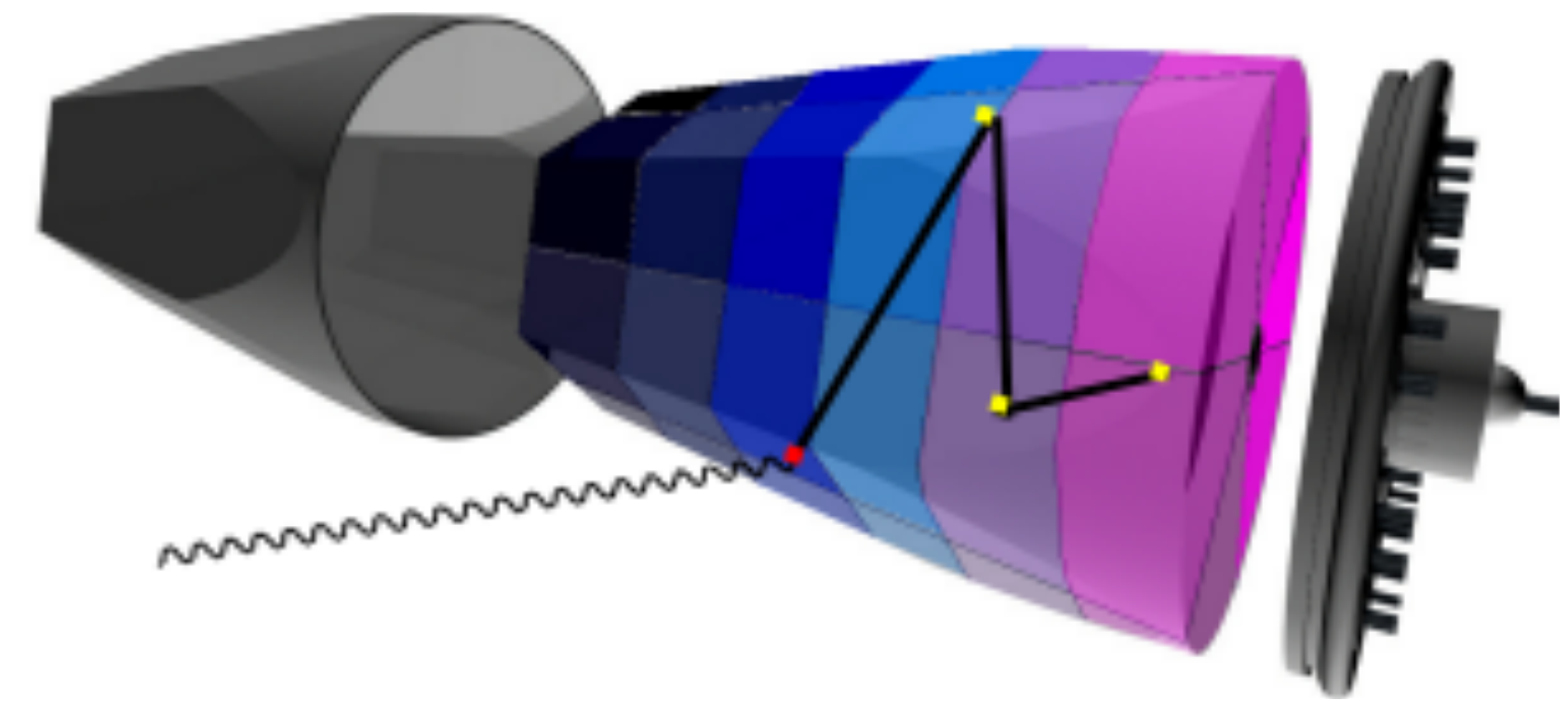



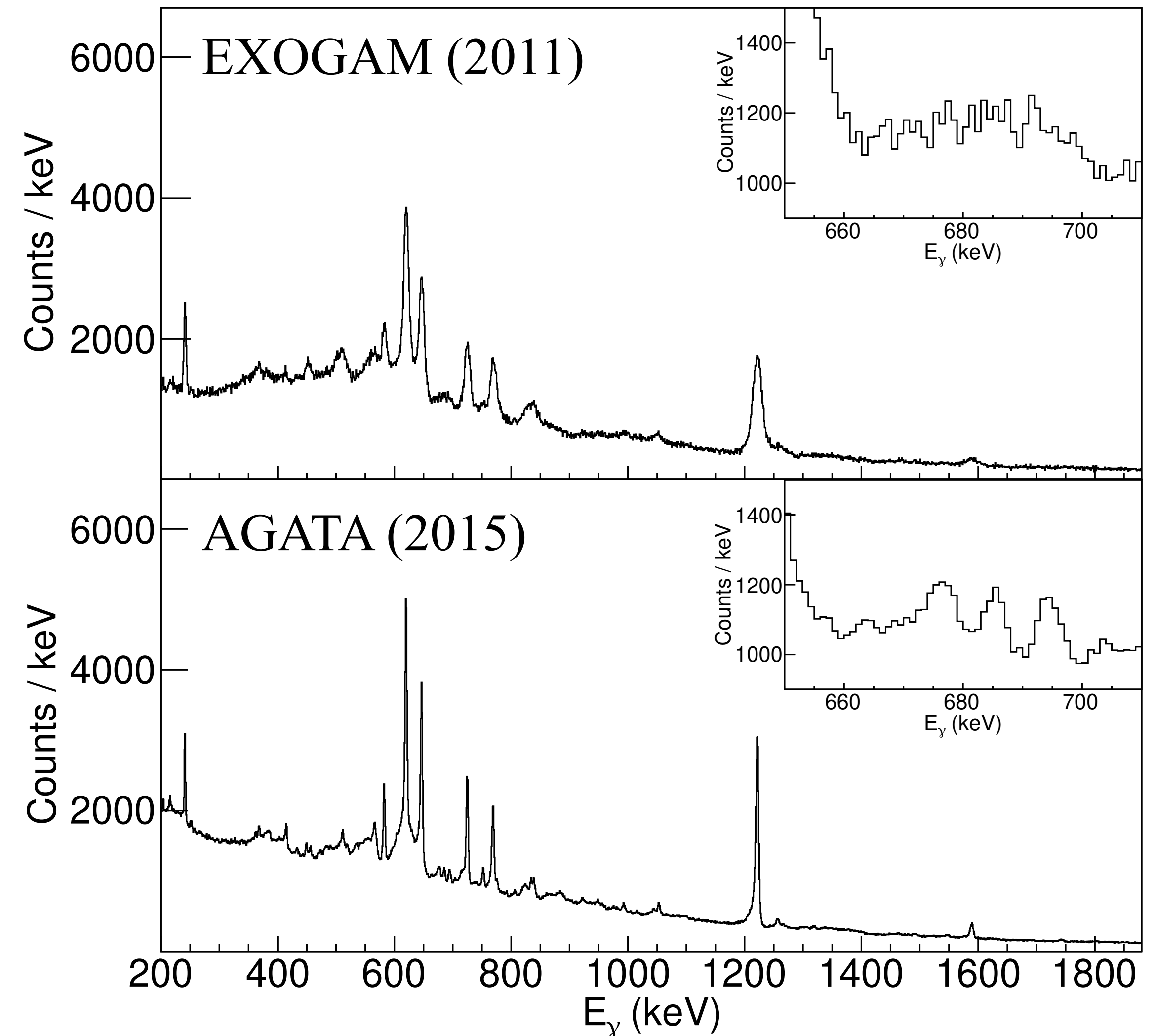

The AGATA Gamma Tracking Array

- ➔ Continuous sphere of segmented HGPe crystals
 - ➔ High energy resolution
 - ➔ High efficiency
- ➔ Full digital electronic:
 - ➔ High counting rates capabilities
 - ➔ Position resolution of interaction points $\sim 5\text{mm}$
- ➔ Tracking of the γ -ray path in the crystals
 - ➔ Increased peak to background ratio
 - ➔ Very precise Doppler Correction



The AGATA / VAMOS++ fission campaigns @ GANIL (2015-2021)

Exp	Duration (days)	VAMOS- γ events	VAMOS			AGATA
			VAMOS angle	Z range	Plunger	Crystals
1	14	6×10^8	28	$\sim [30 ; 45]$		24
2	10	2×10^8	28	$\sim [30 ; 45]$		24
3	14	4×10^8	20	$\sim [35 ; 60]$		32
4	10	4×10^8	19	$\sim [35 ; 60]$		35

The AGATA / VAMOS++ fission campaigns @ GANIL (2015-2021)

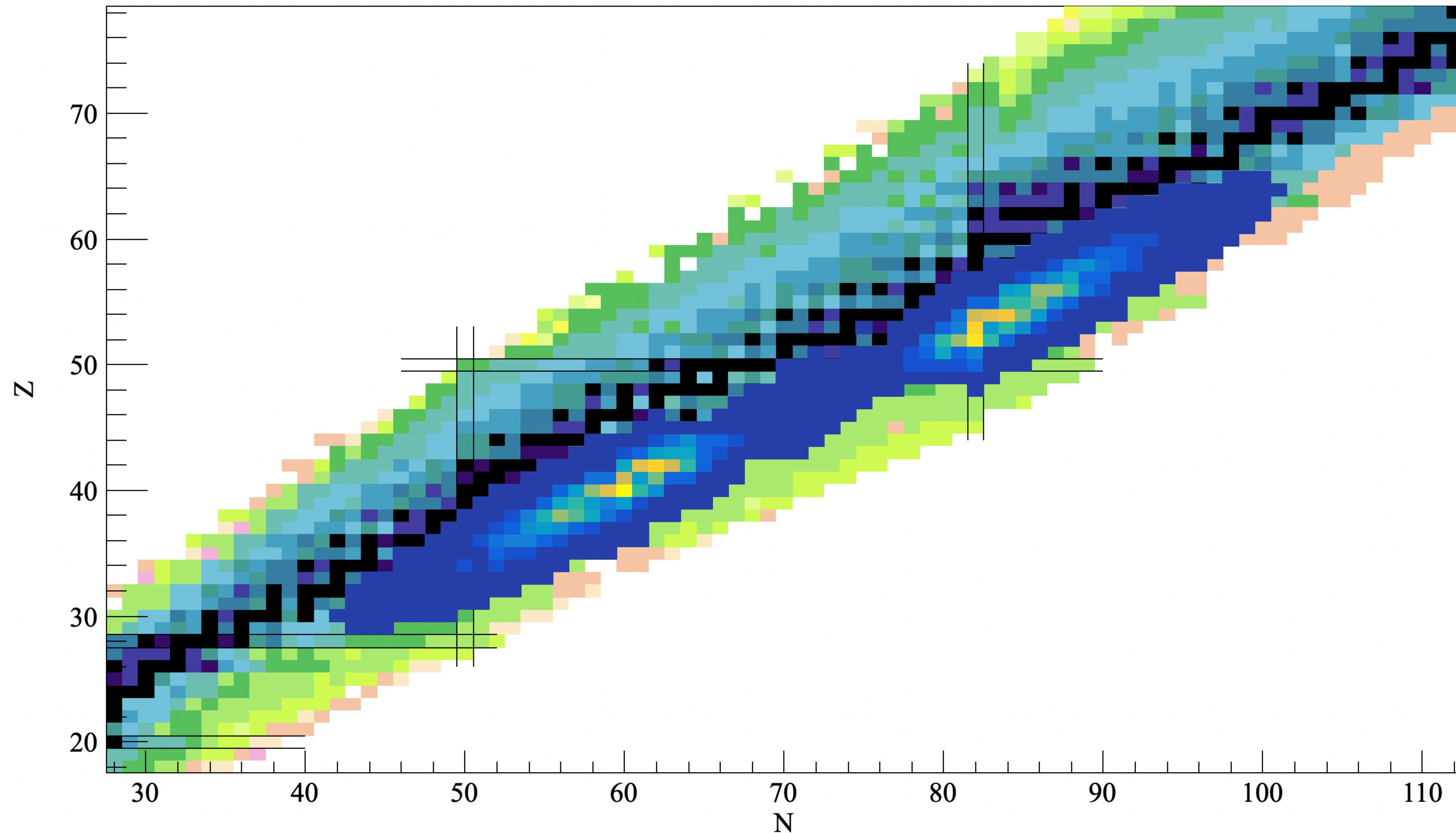

The AGATA / VAMOS++ fission campaigns @ GANIL (2015-2021)

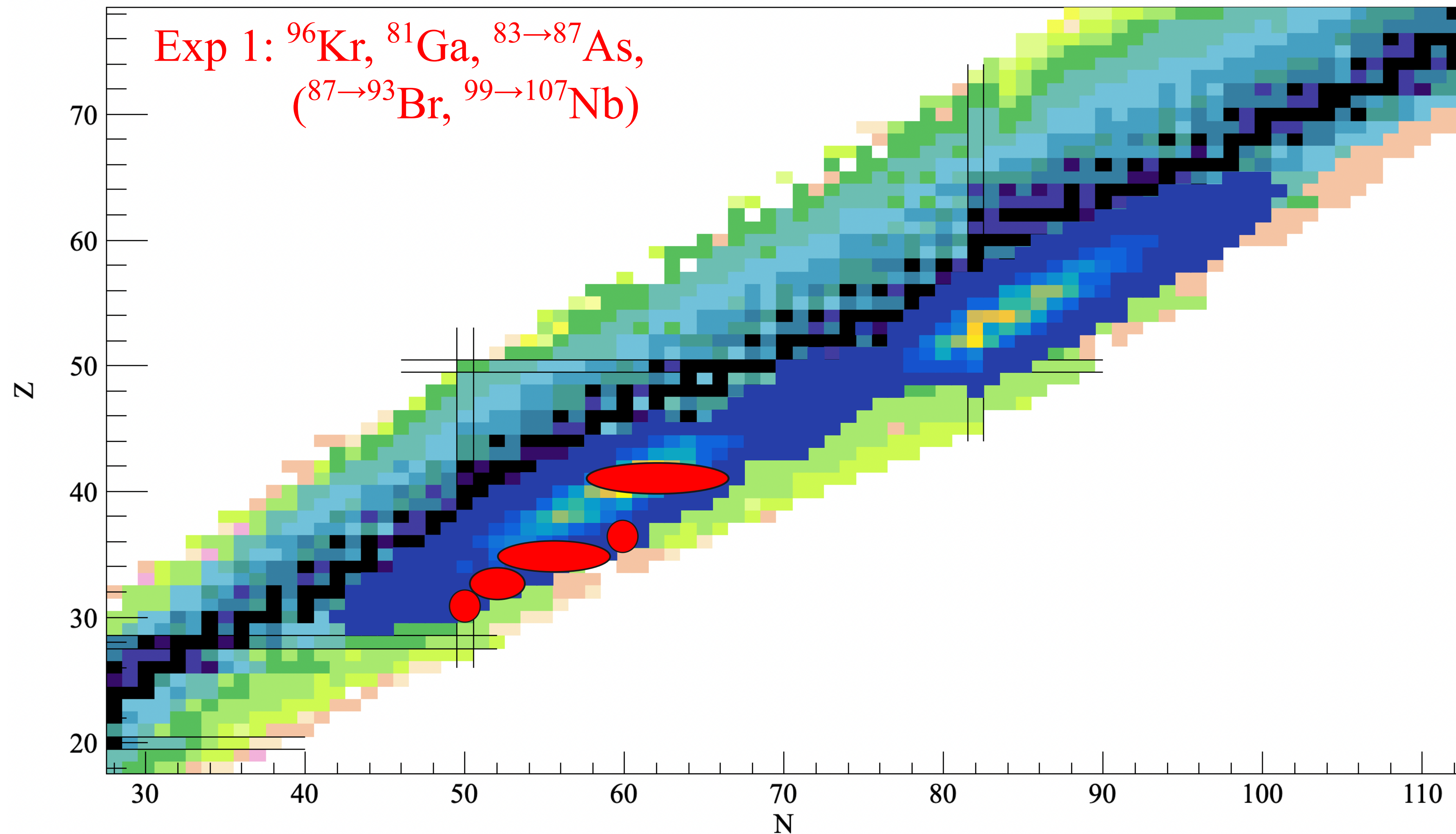

The AGATA / VAMOS++ fission campaigns @ GANIL (2015-2021)

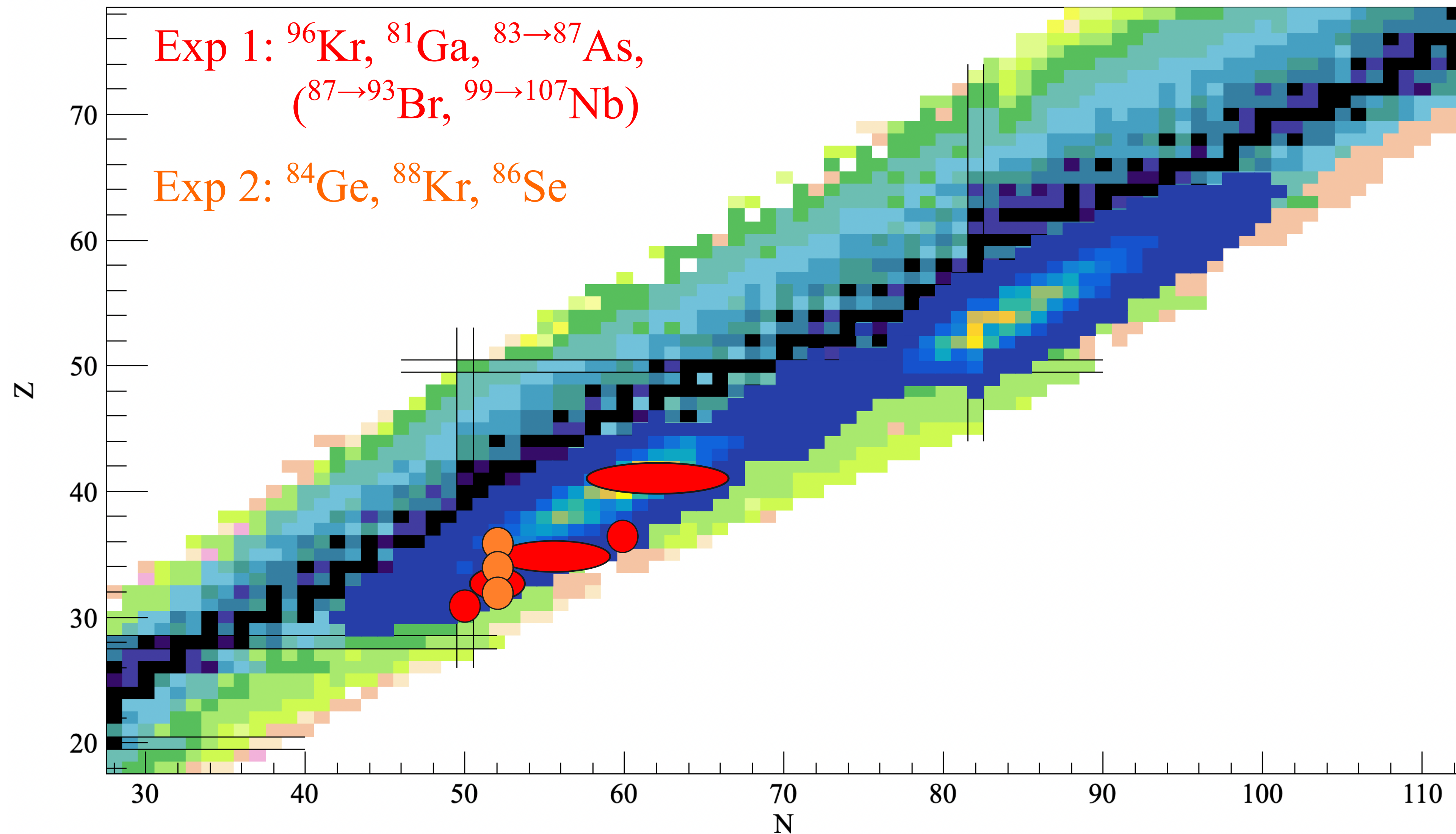

The AGATA / VAMOS++ fission campaigns @ GANIL (2015-2021)

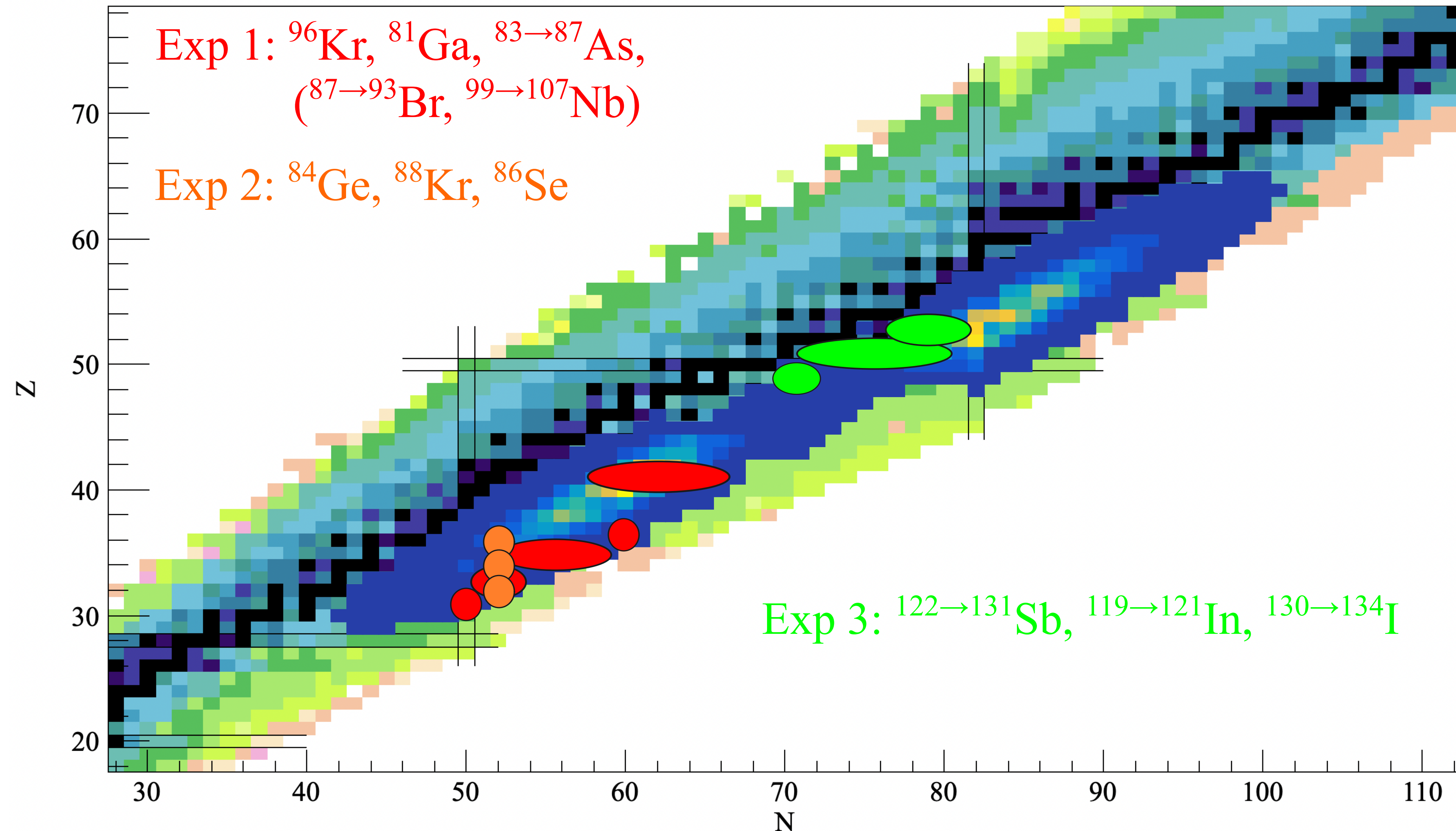

The AGATA / VAMOS++ fission campaigns @ GANIL (2015-2021)

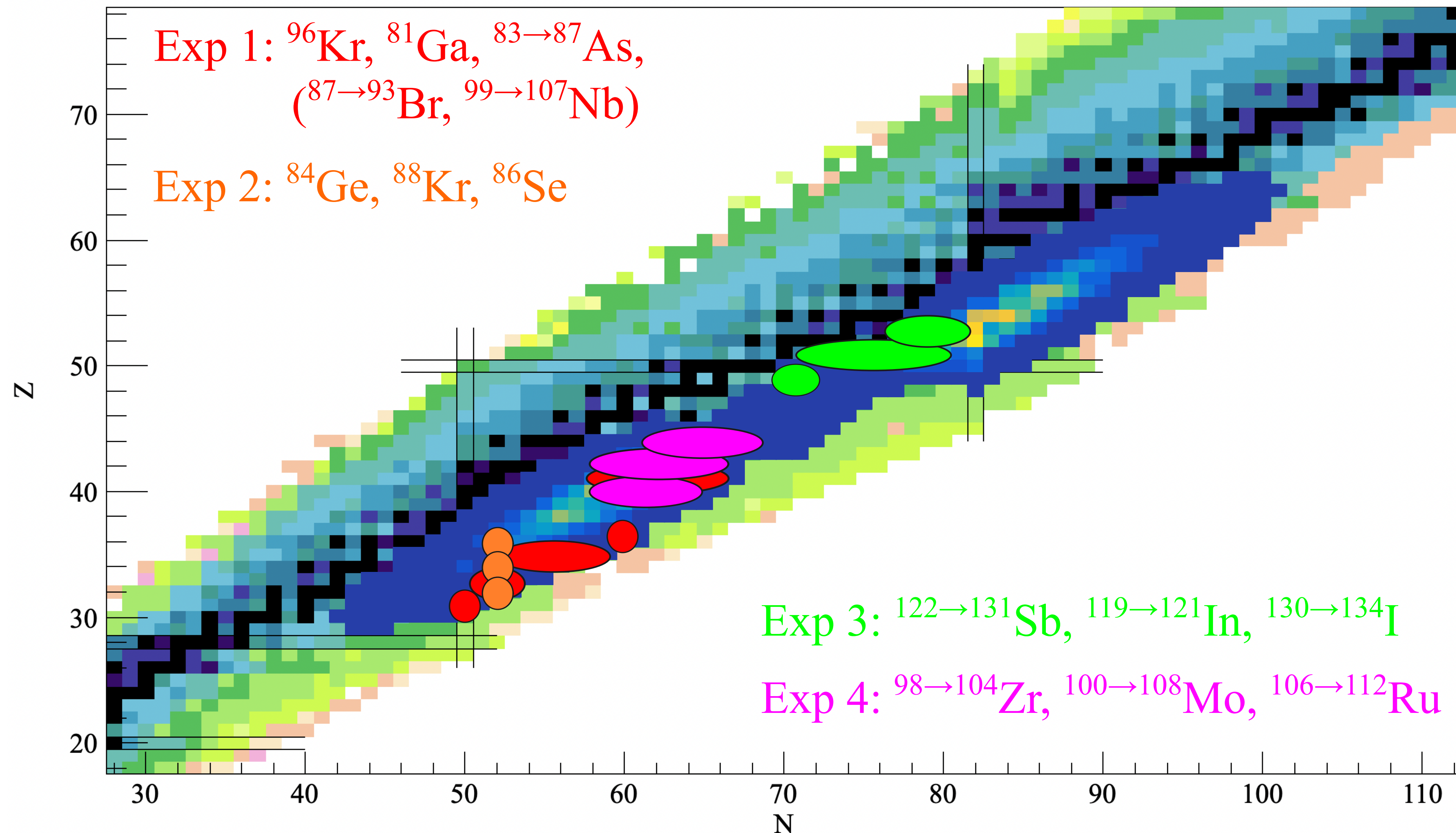

Some physics cases: The ^{96}Kr spectroscopy

- ➔ Spectacular shape transition at $N=60$ due to a shape coexistence phenomenon
- ➔ Well described theoretically by Monte-Carlo Shell Model calculation at $Z=40$
- ➔ but still challenging to describe the limits of this region theoretically

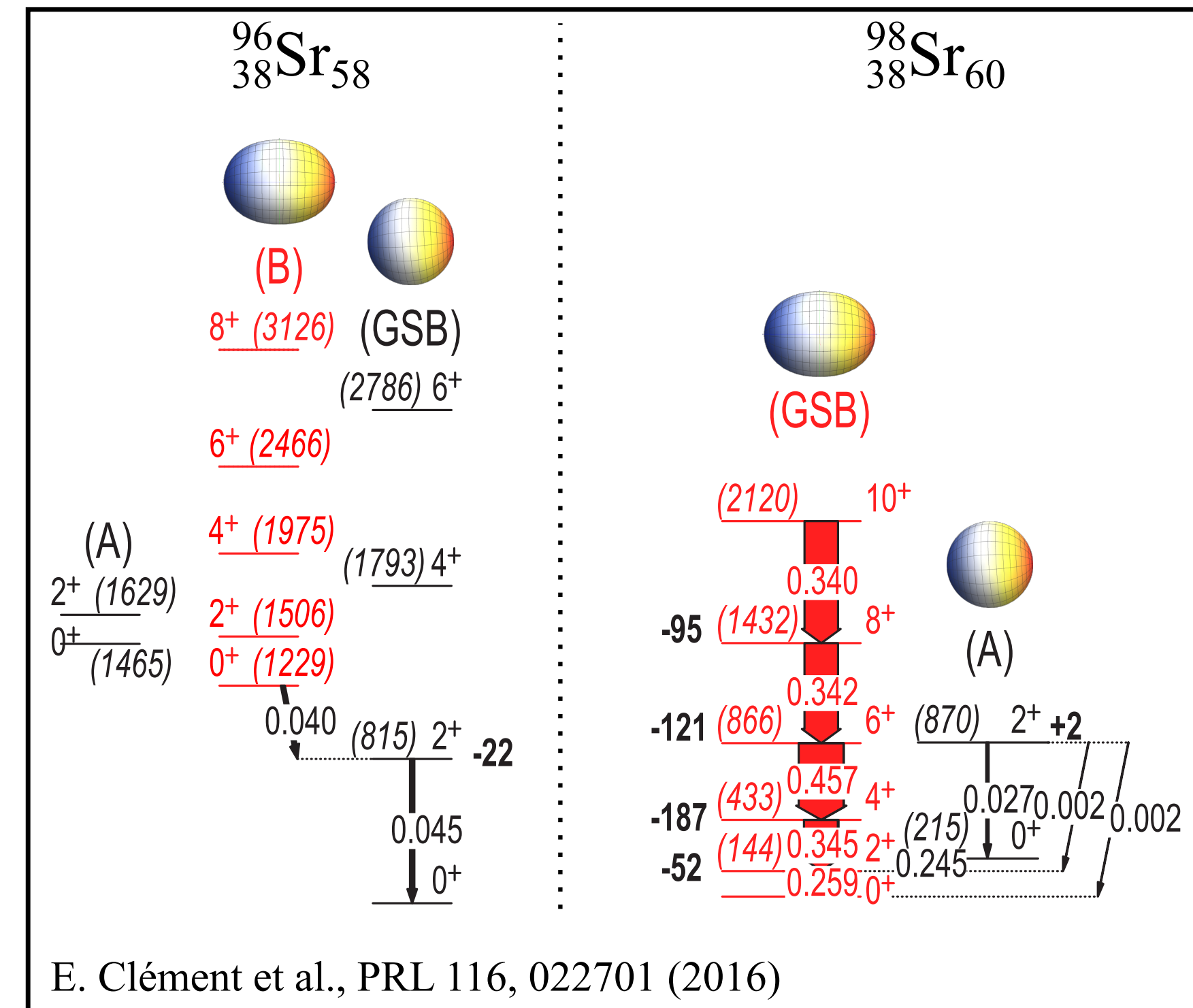
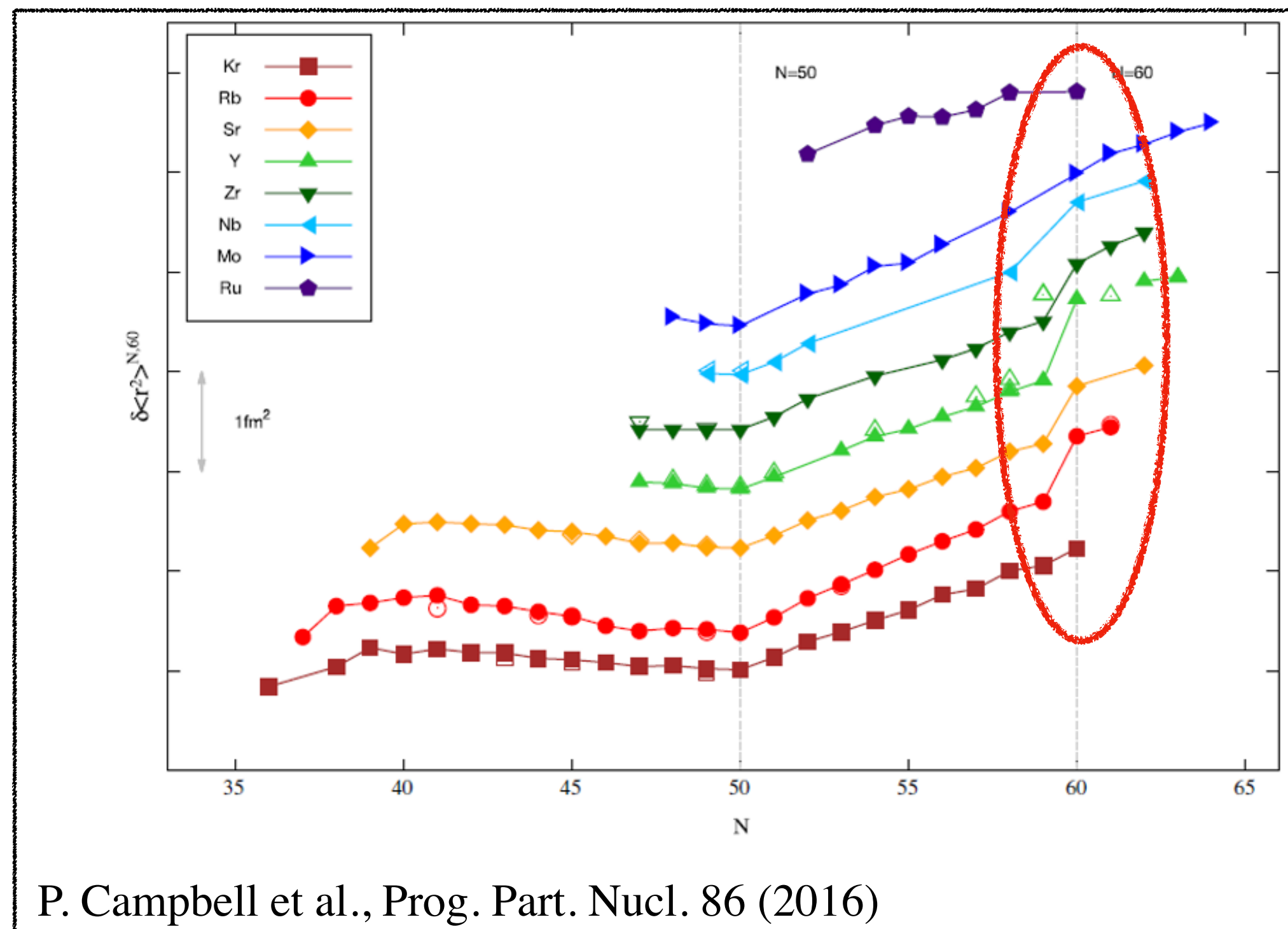

Some physics cases: The ^{96}Kr spectroscopy

- ➔ Spectacular shape transition at $N=60$ due to a shape coexistence phenomenon
- ➔ Well described theoretically by Monte-Carlo Shell Model calculation at $Z=40$
- ➔ but still challenging to describe the limits of this region theoretically

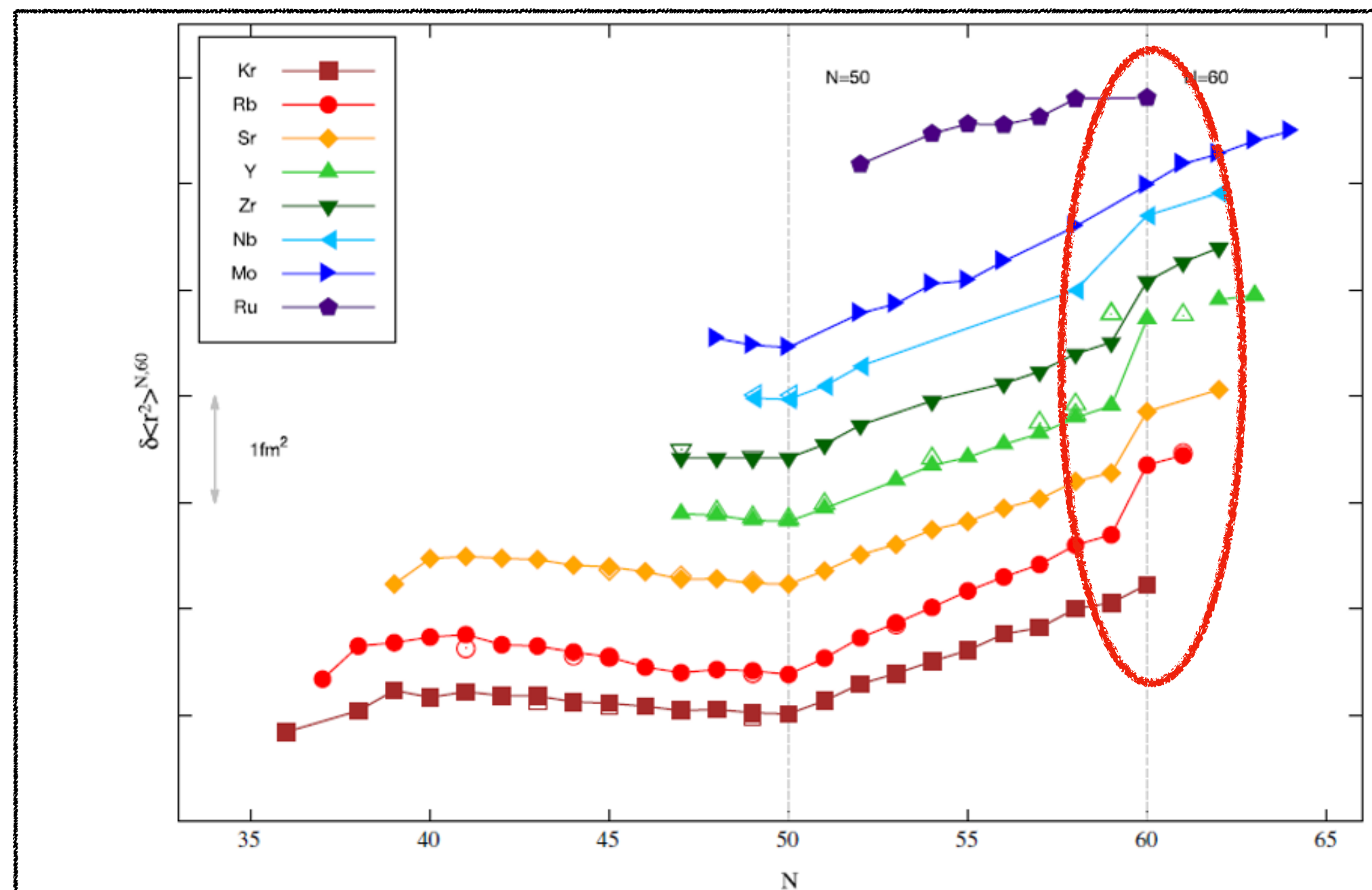

P. Campbell et al., Prog. Part. Nucl. 86 (2016)

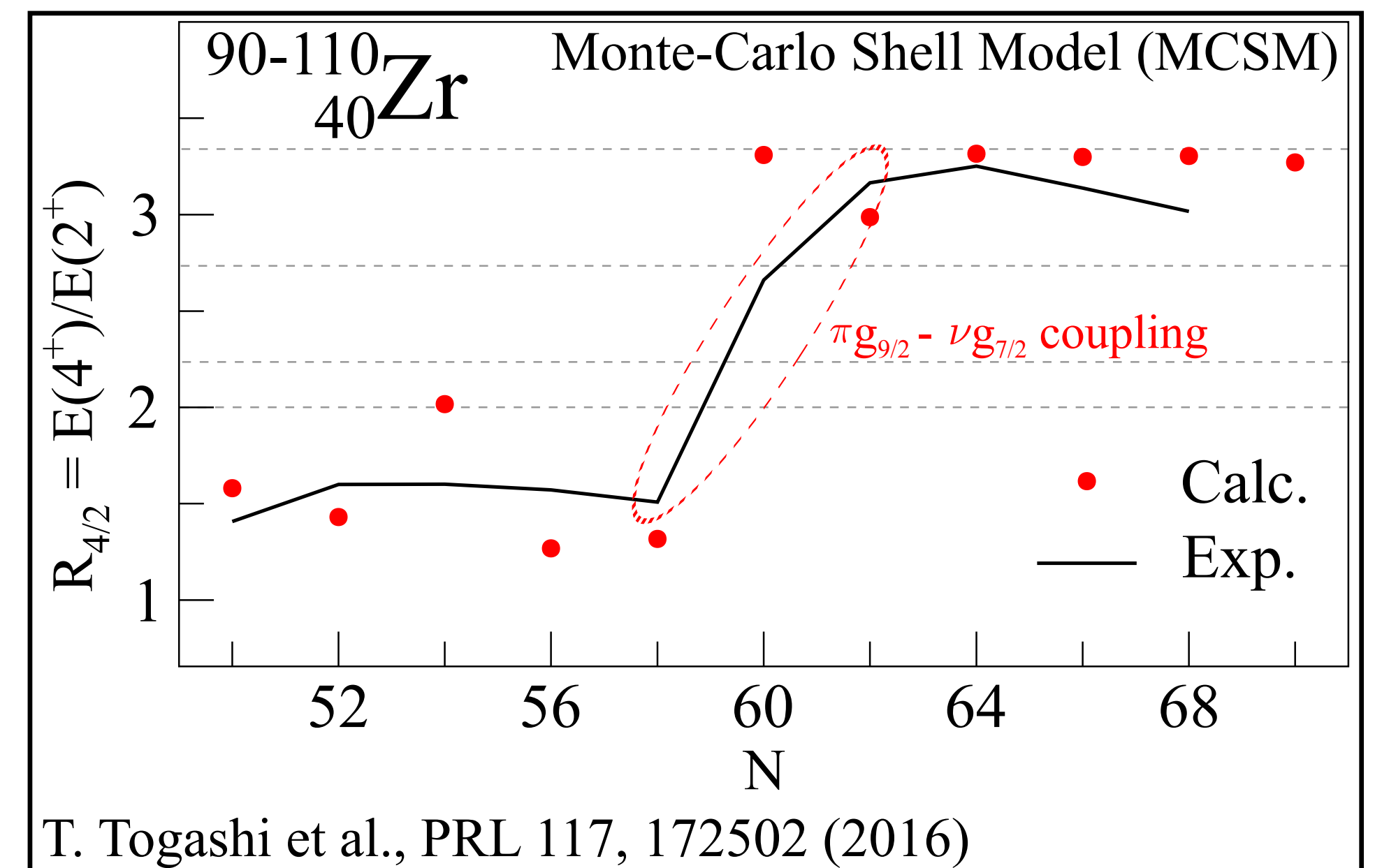

T. Togashi et al., PRL 117, 172502 (2016)

Some physics cases: The ^{96}Kr spectroscopy

➔ First result from the fission campaigns at GANIL: ^{96}Kr , as the low Z-boundary of this deformation region

➔ First measurement of the 4^+ level in ^{96}Kr

➔ Kr follows an unexpected trend between $R_{4/2}$ and $B(E2)$: hints of oblate/prolate shape coexistence ?

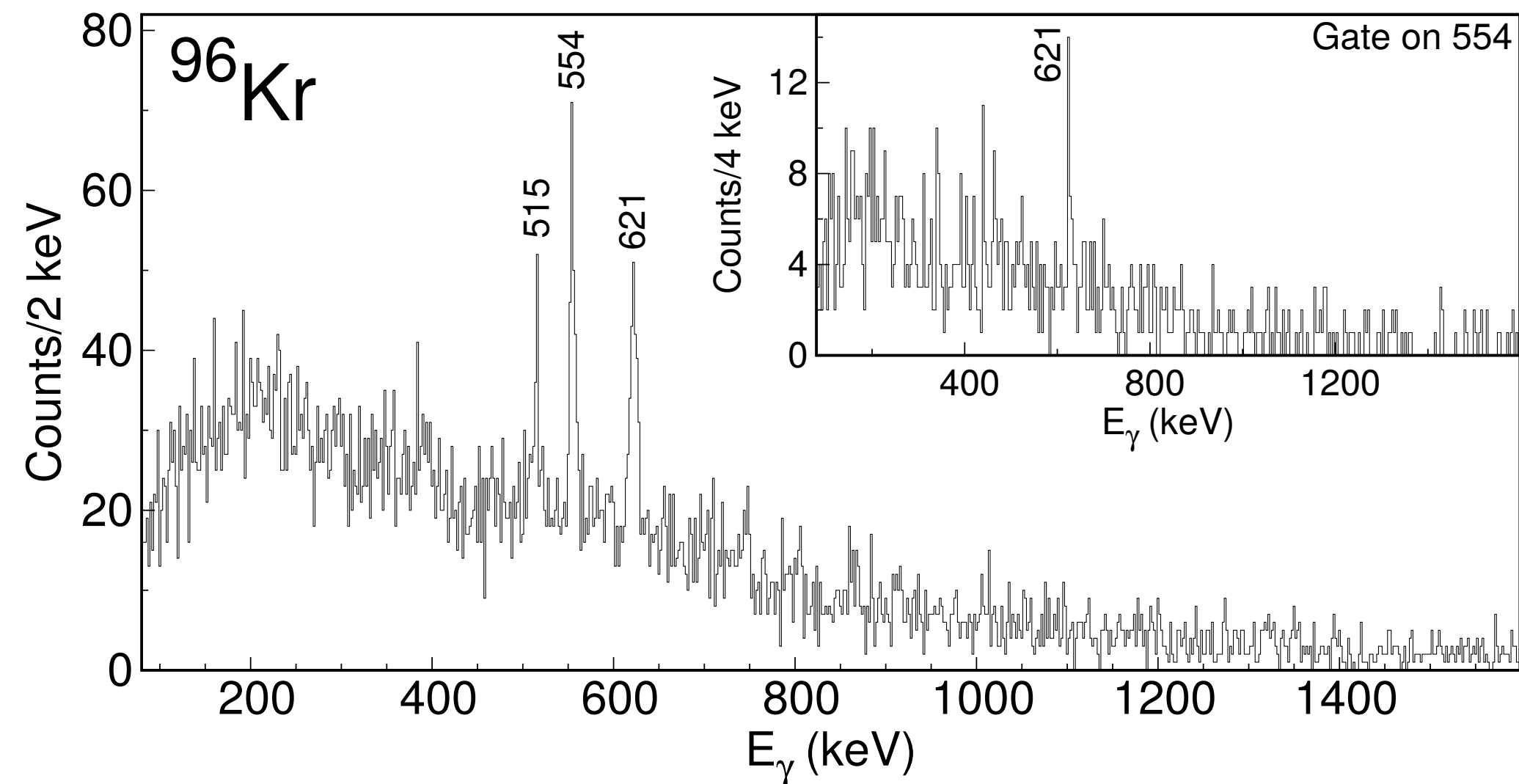

J. Dudouet et al., Phys. Rev. Lett 118, 162501 (2017)

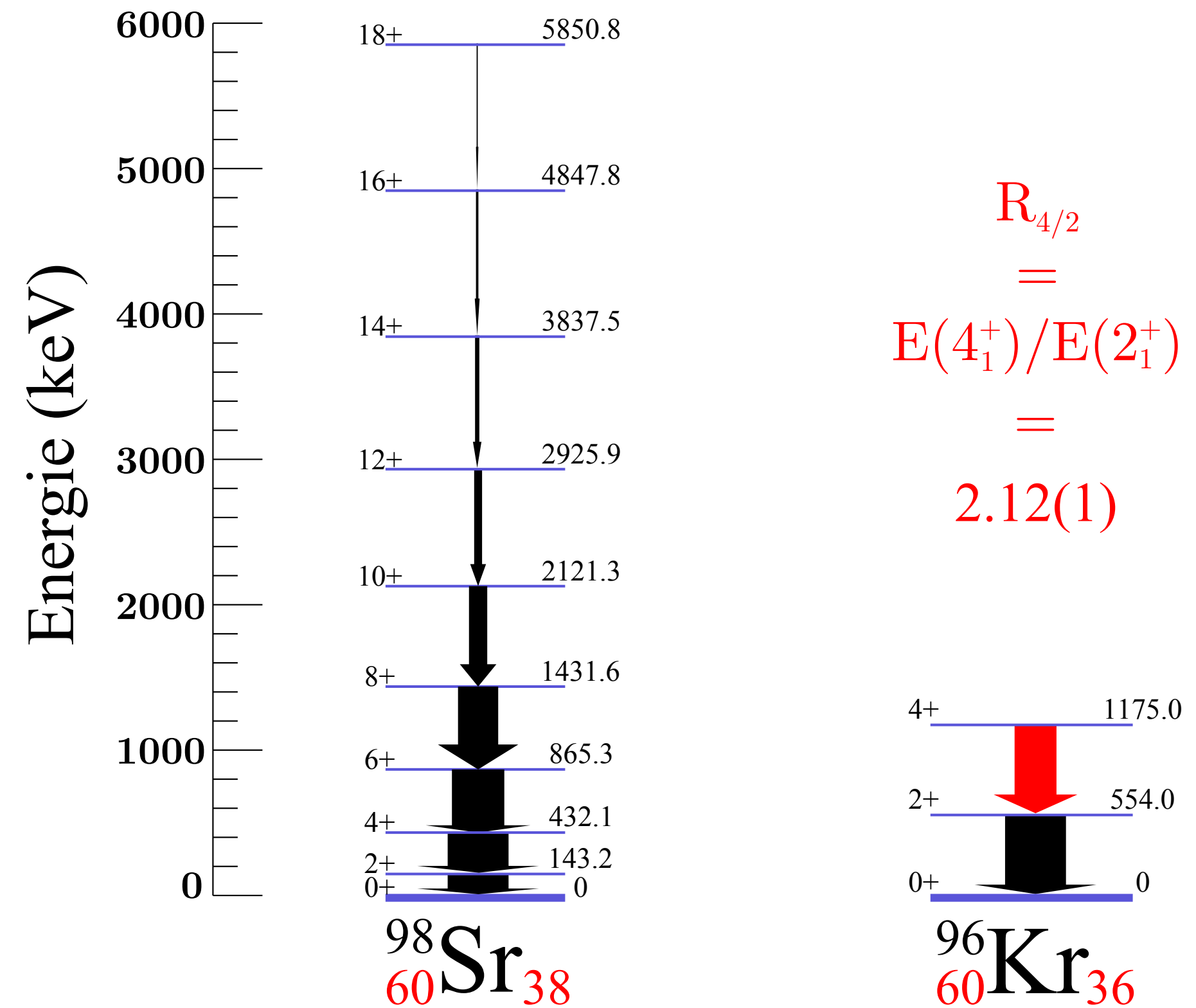

Some physics cases: The ^{96}Kr spectroscopy

➔ First result from the fission campaigns at GANIL: ^{96}Kr , as the low Z-boundary of this deformation region

➔ First measurement of the 4^+ level in ^{96}Kr

➔ Kr follows an unexpected trend between $R_{4/2}$ and $B(E2)$: hints of oblate/prolate shape coexistence ?

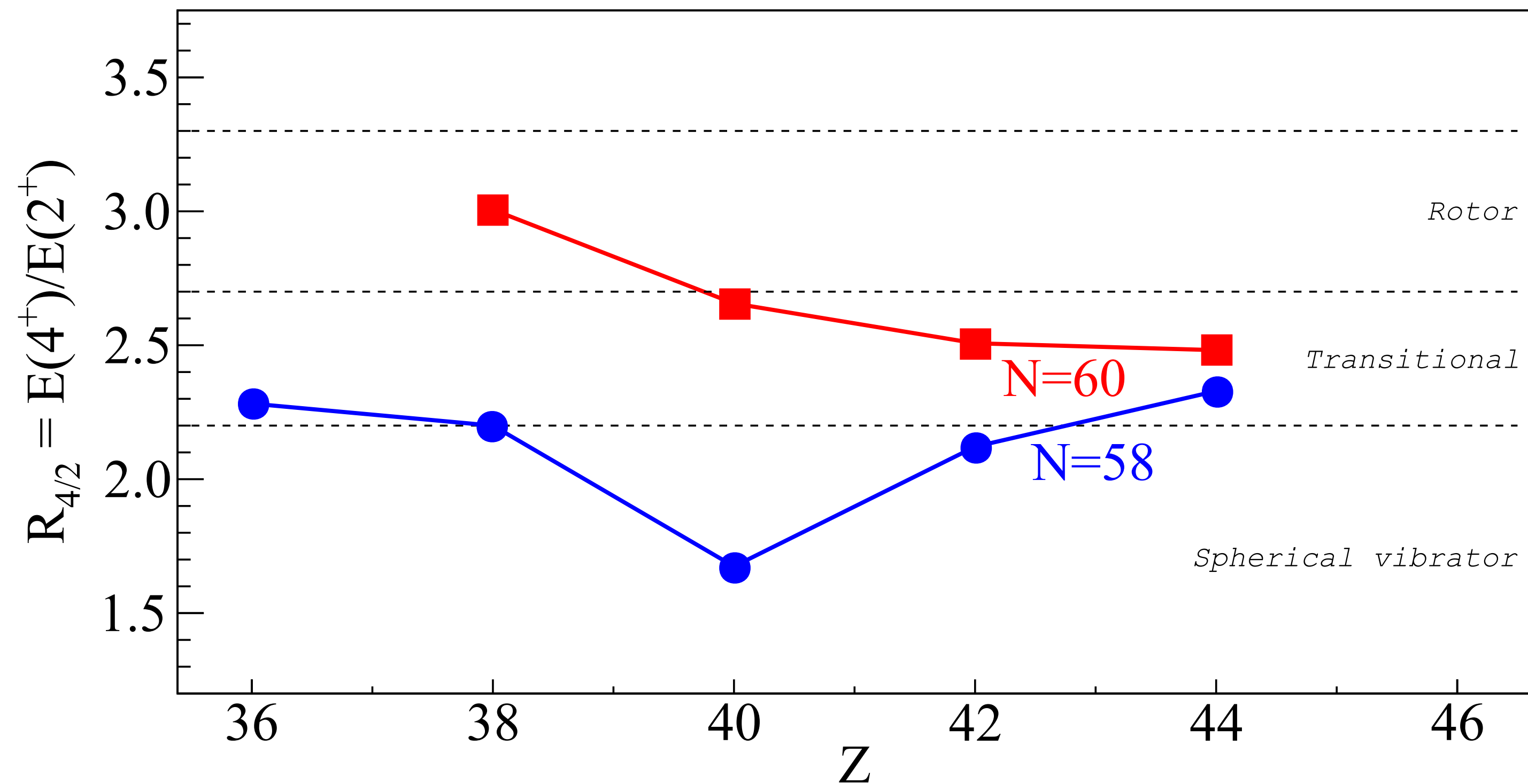

J. Dudouet et al., Phys. Rev. Lett 118, 162501 (2017)

Some physics cases: The ^{96}Kr spectroscopy

- ➔ First result from the fission campaigns at GANIL: ^{96}Kr , as the low Z-boundary of this deformation region
- ➔ First measurement of the 4^+ level in ^{96}Kr
- ➔ Kr follows an unexpected trend between $R_{4/2}$ and $B(E2)$: hints of oblate/prolate shape coexistence ?

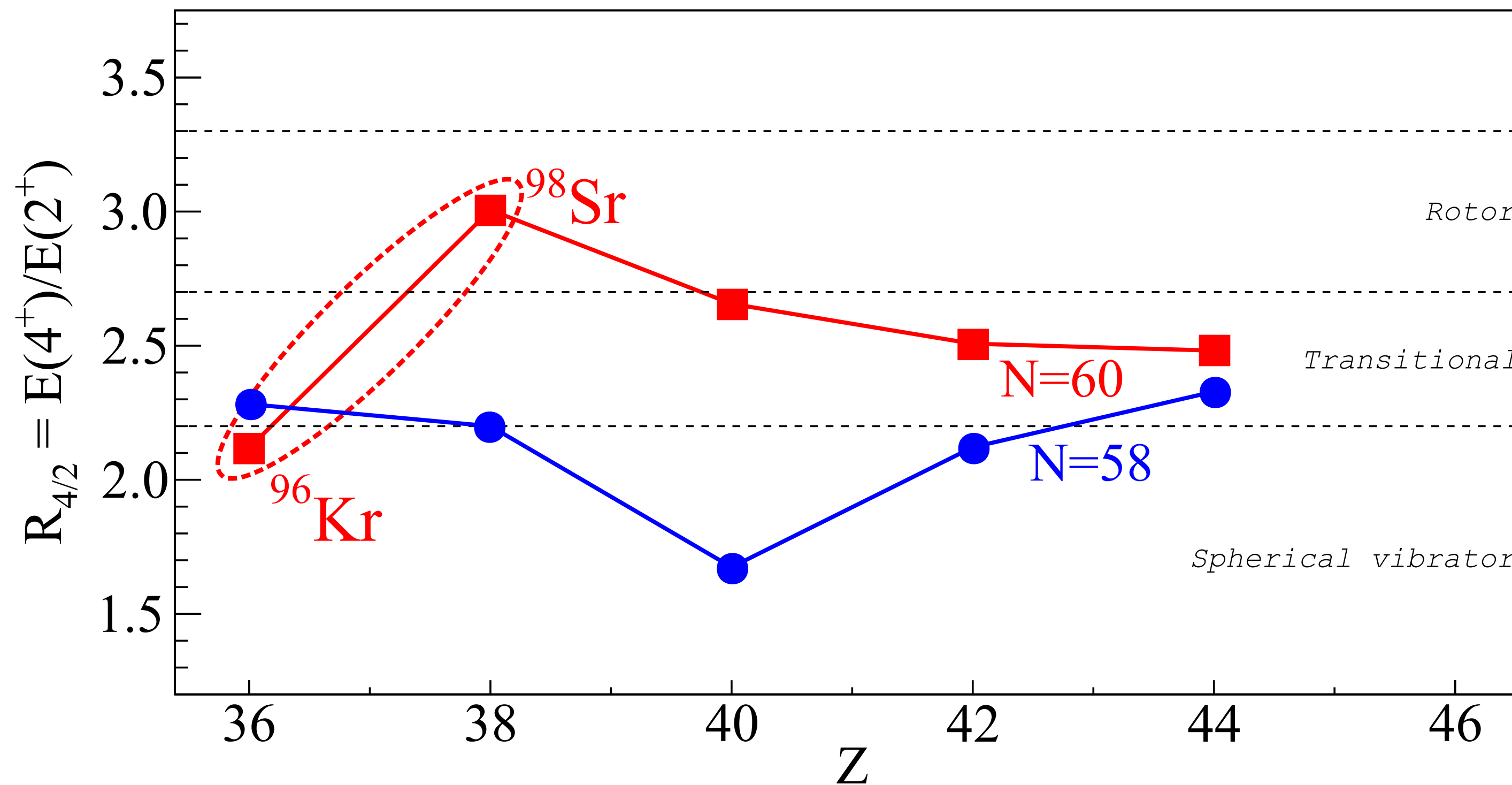

J. Dudouet et al., Phys. Rev. Lett 118, 162501 (2017)

Some physics cases: The ^{96}Kr spectroscopy

- ➔ First result from the fission campaigns at GANIL: ^{96}Kr , as the low Z-boundary of this deformation region
- ➔ First measurement of the 4^+ level in ^{96}Kr
- ➔ Kr follows an unexpected trend between $R_{4/2}$ and $B(E2)$: hints of oblate/prolate shape coexistence ?

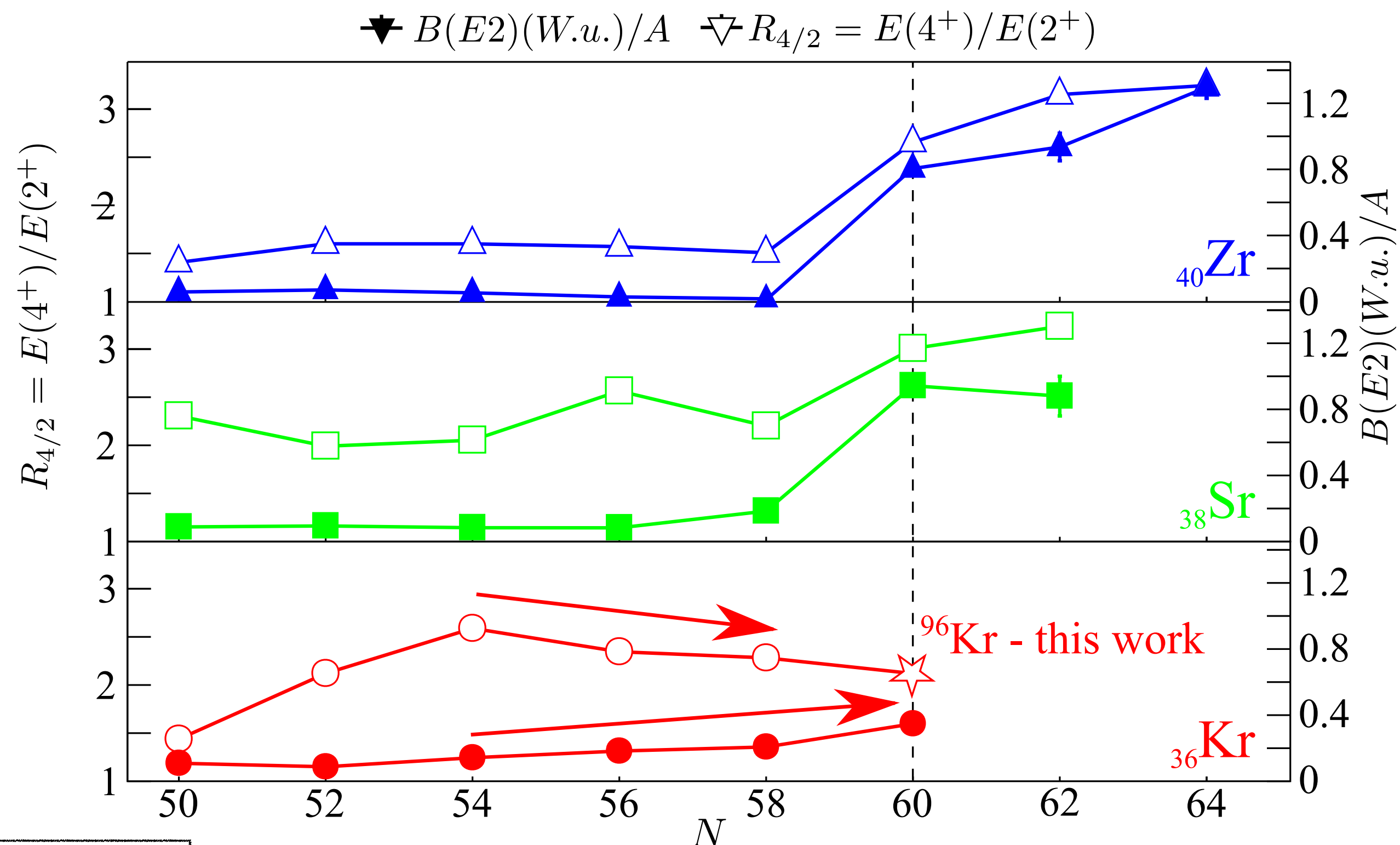

J. Dudouet et al., Phys. Rev. Lett 118, 162501 (2017)

Some physics cases: Lifetimes in neutron rich Zr, Mo and Ru

➔ Lifetime measurements in the Zr, Mo, Ru nuclei using RDDS* method

* Recoil Distance Doppler Shift

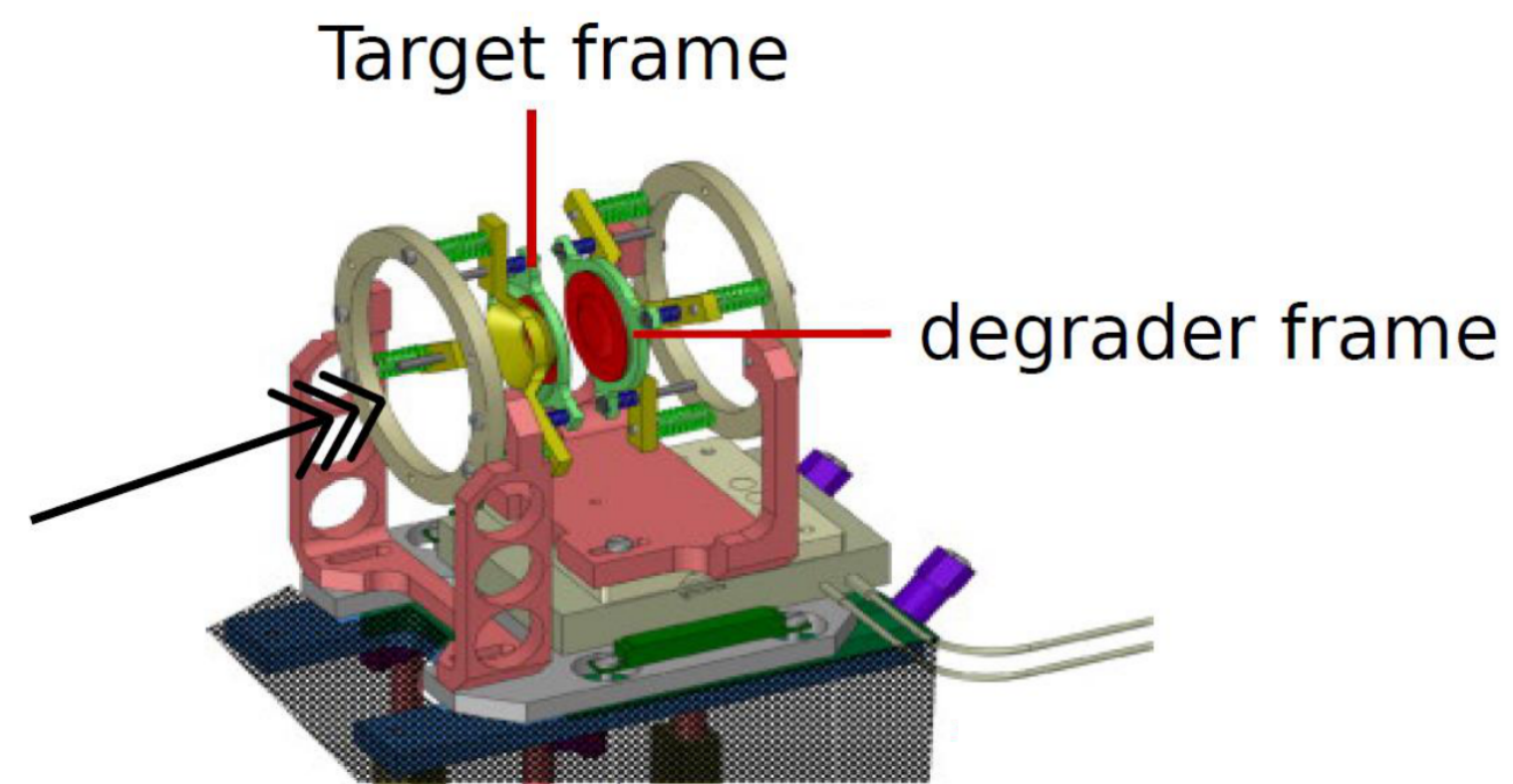

The OUPS Plunger: adapted from S. Ansari PhD thesis

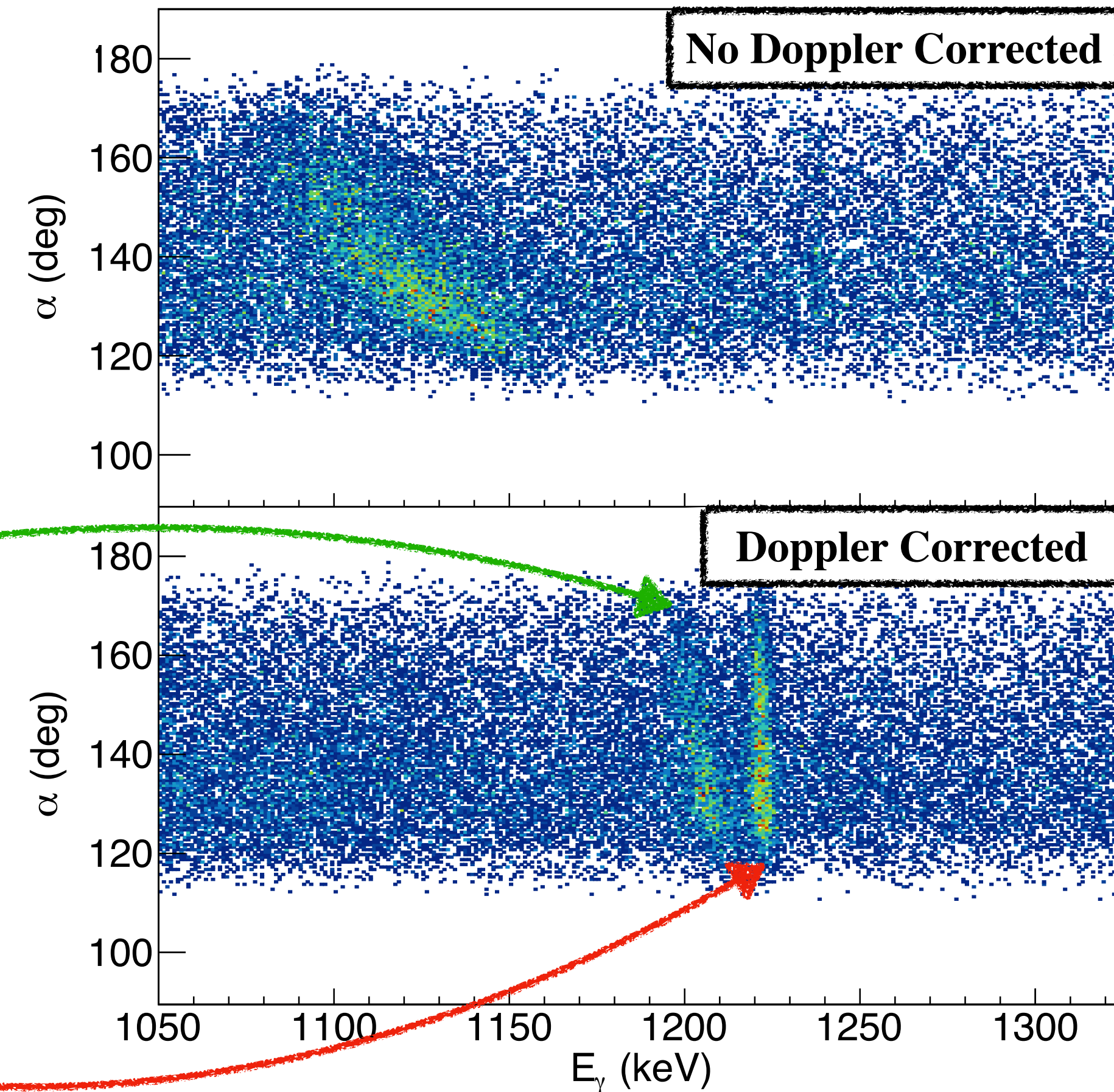
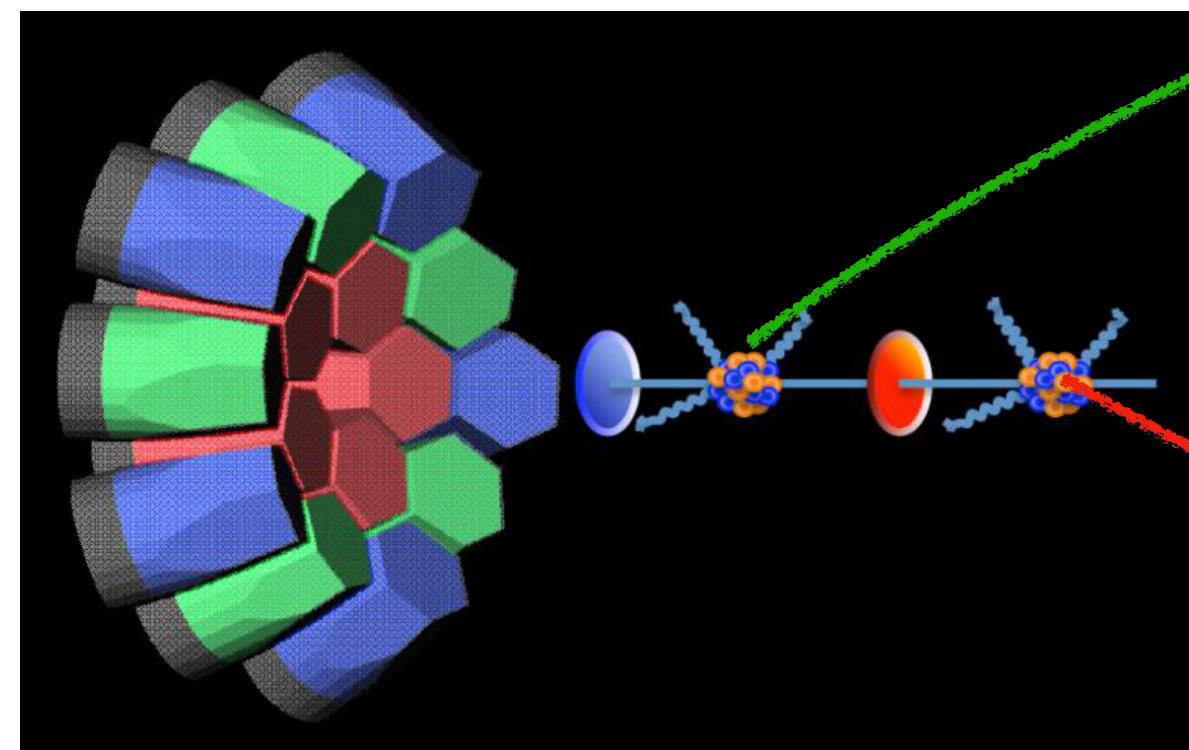

Some physics cases: Lifetimes in neutron rich Zr, Mo and Ru

➔ Lifetime measurements in the Zr, Mo, Ru nuclei using RDDS* method

* Recoil Distance Doppler Shift

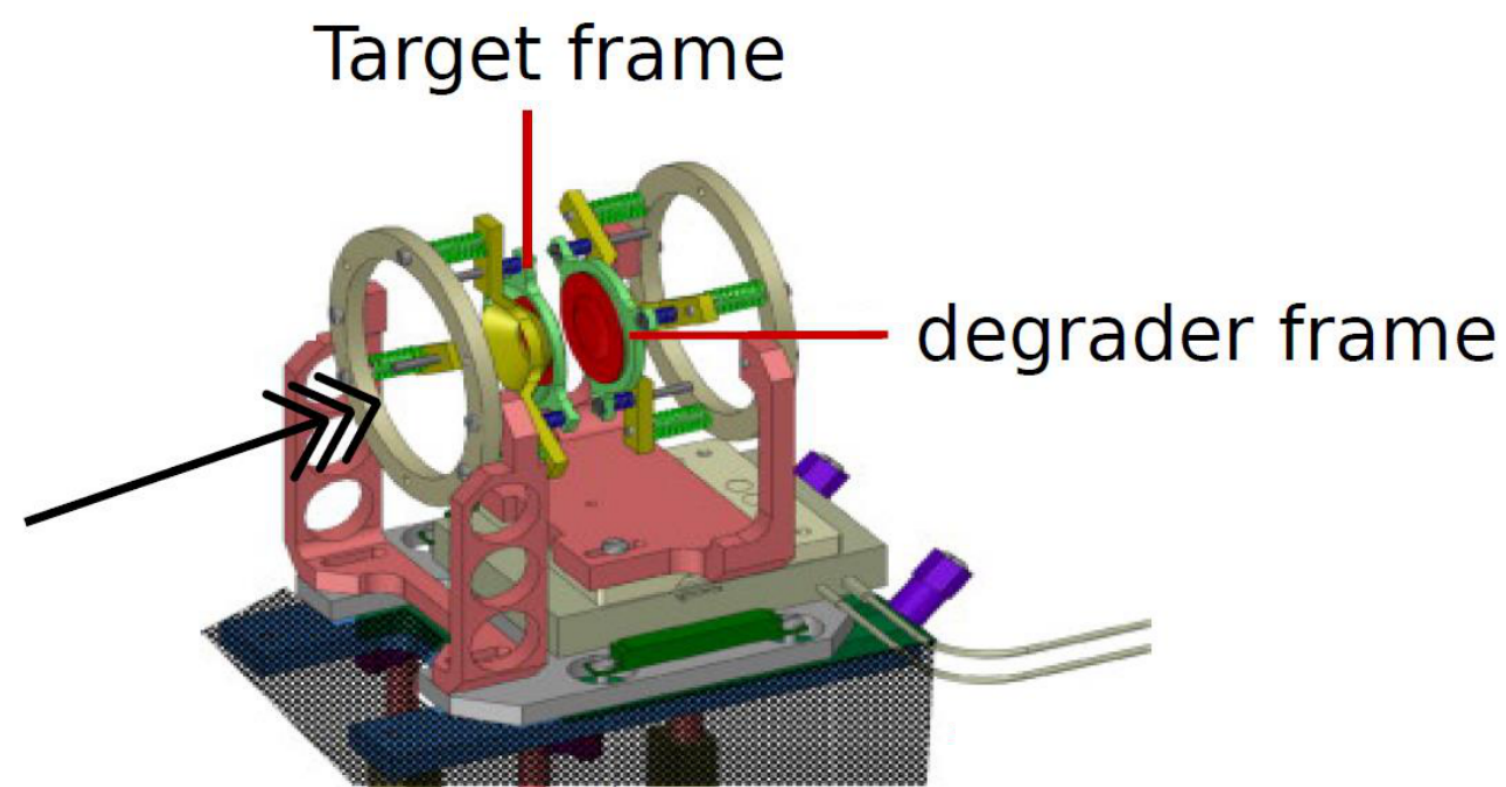

The OUPS Plunger: adapted from S. Ansari PhD thesis

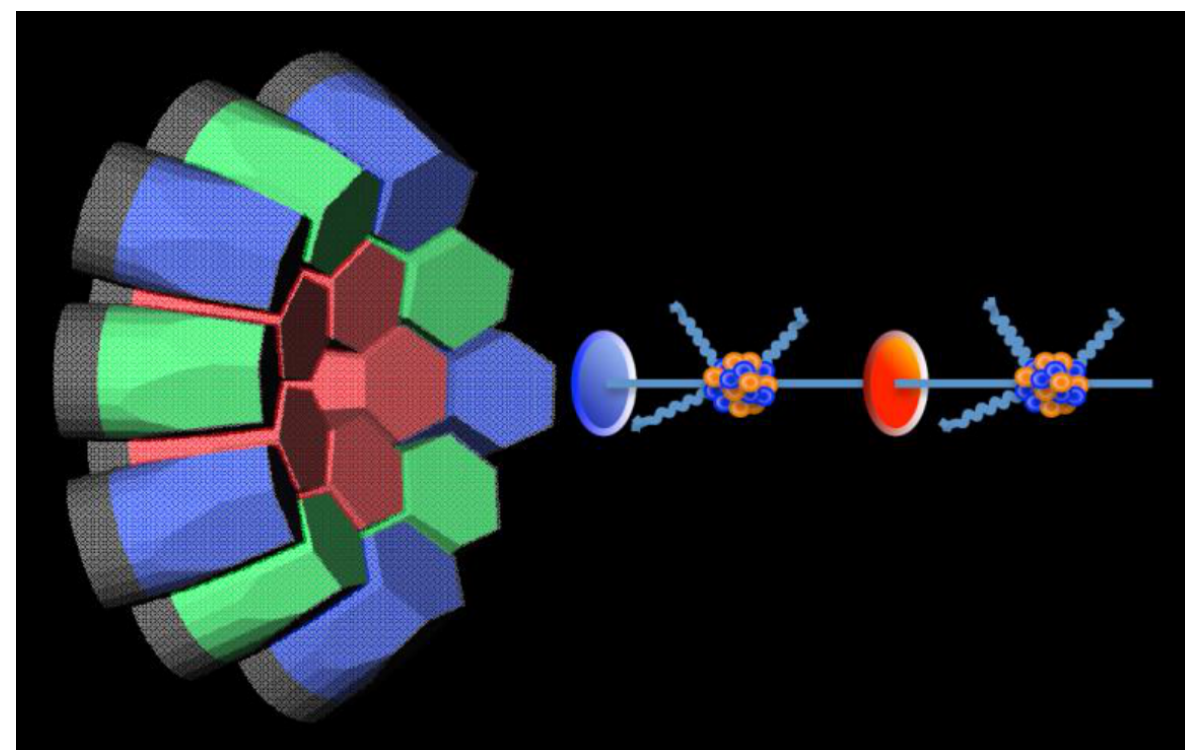

^{104}Mo : 4^+ state

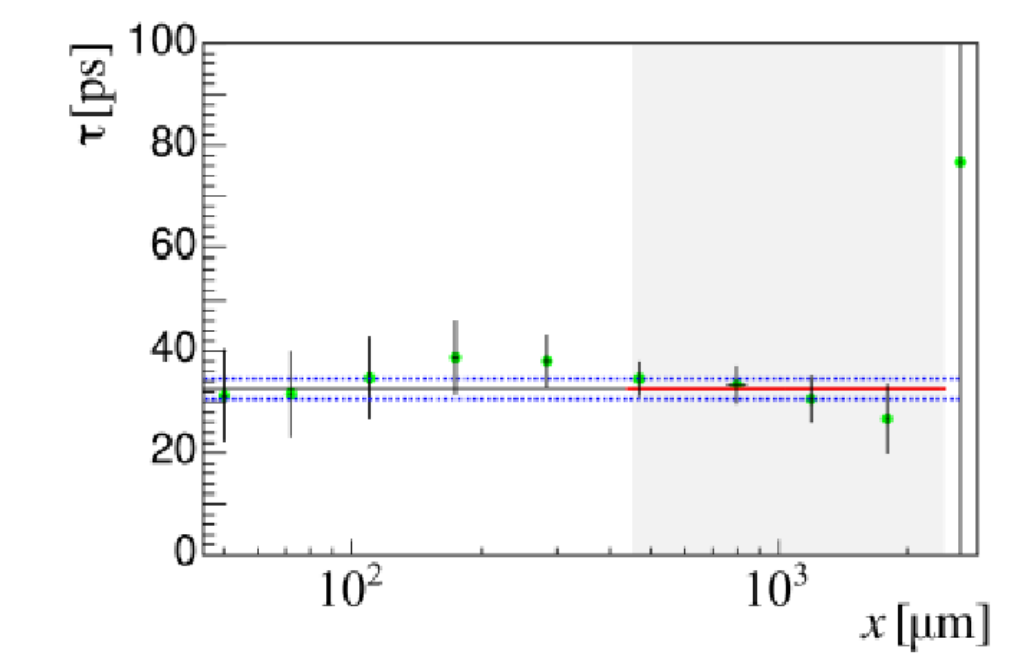
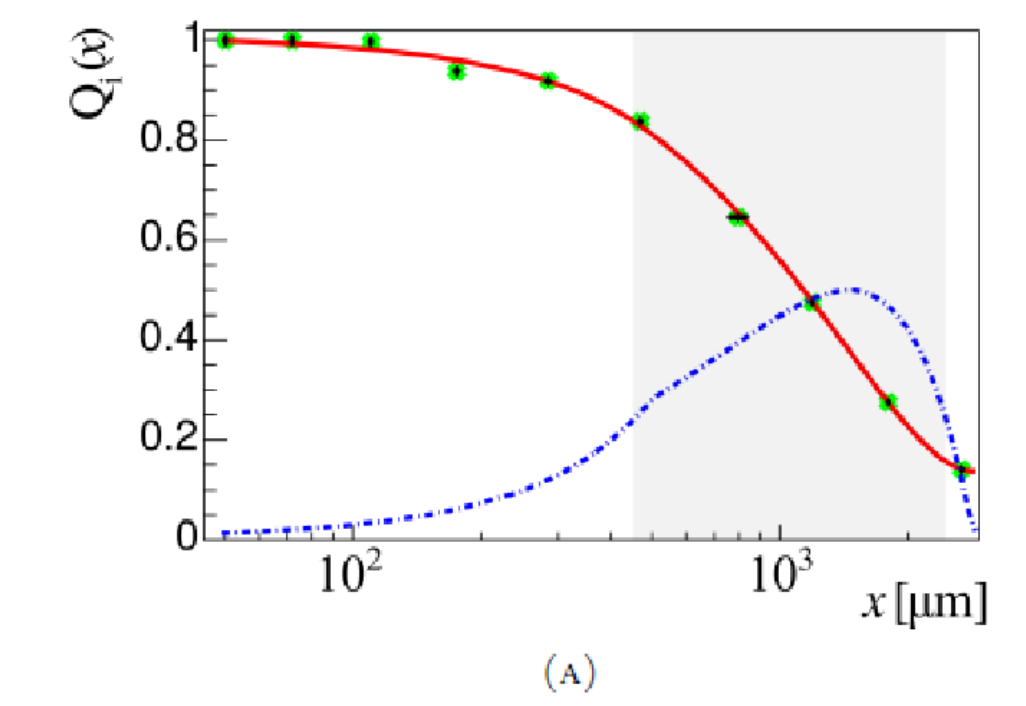
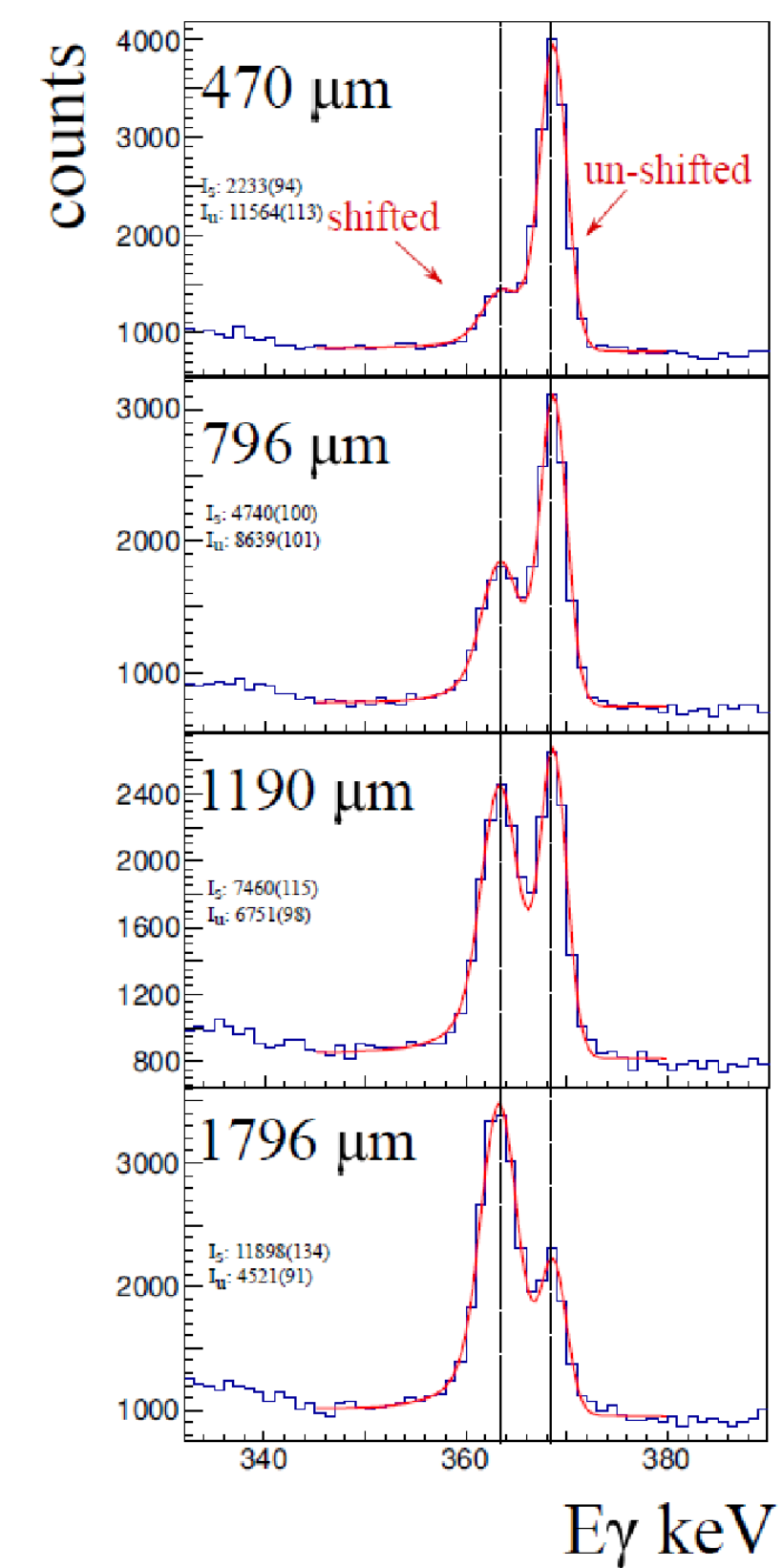

$\tau(4^+) = 32.6(20)$ ps

Some physics cases: Lifetimes in neutron rich Zr, Mo and Ru

➔ Lifetime measurements in the Zr, Mo, Ru nuclei using RDDS

➔ A lot of new lifetimes measured in this region to constrain nuclear models

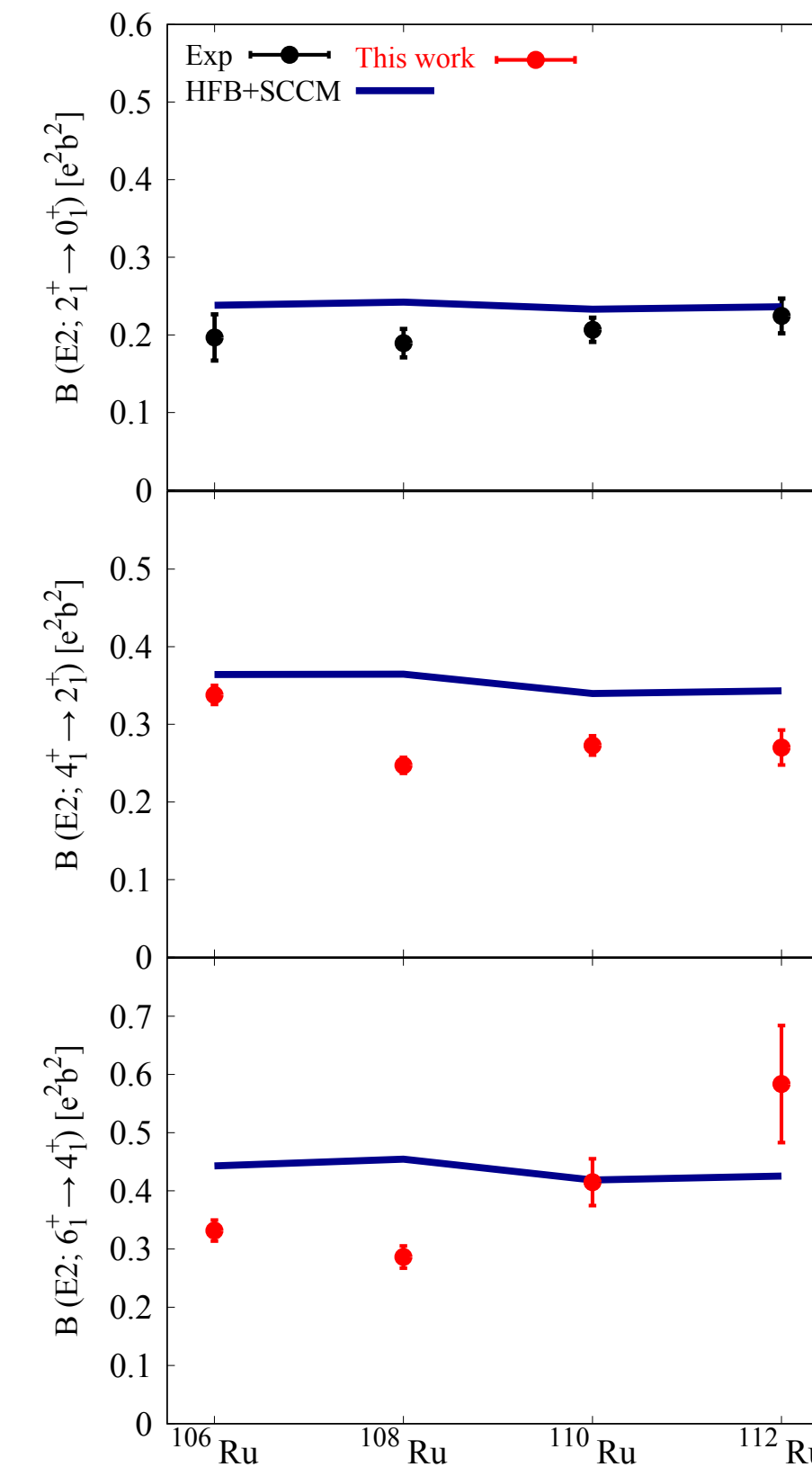
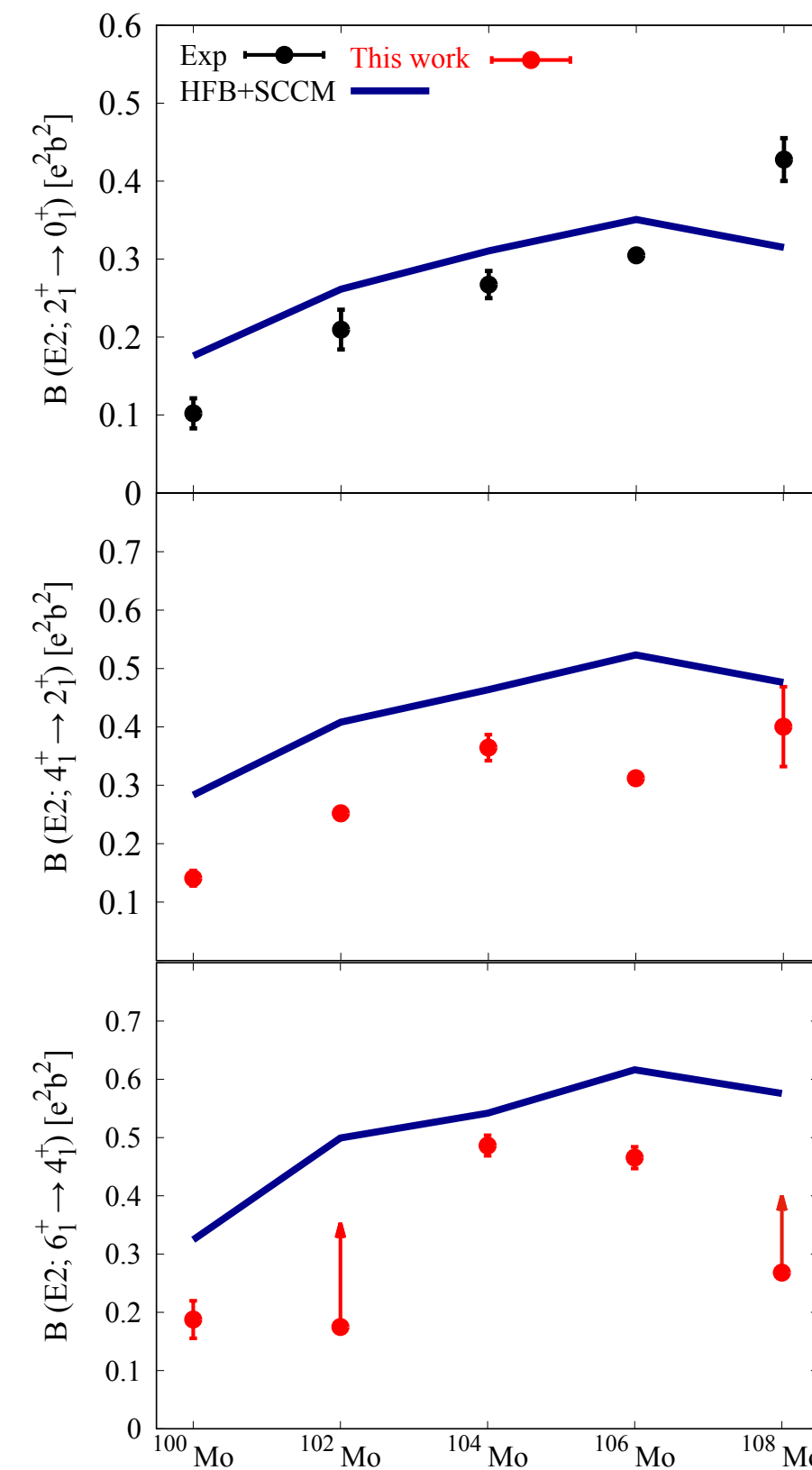
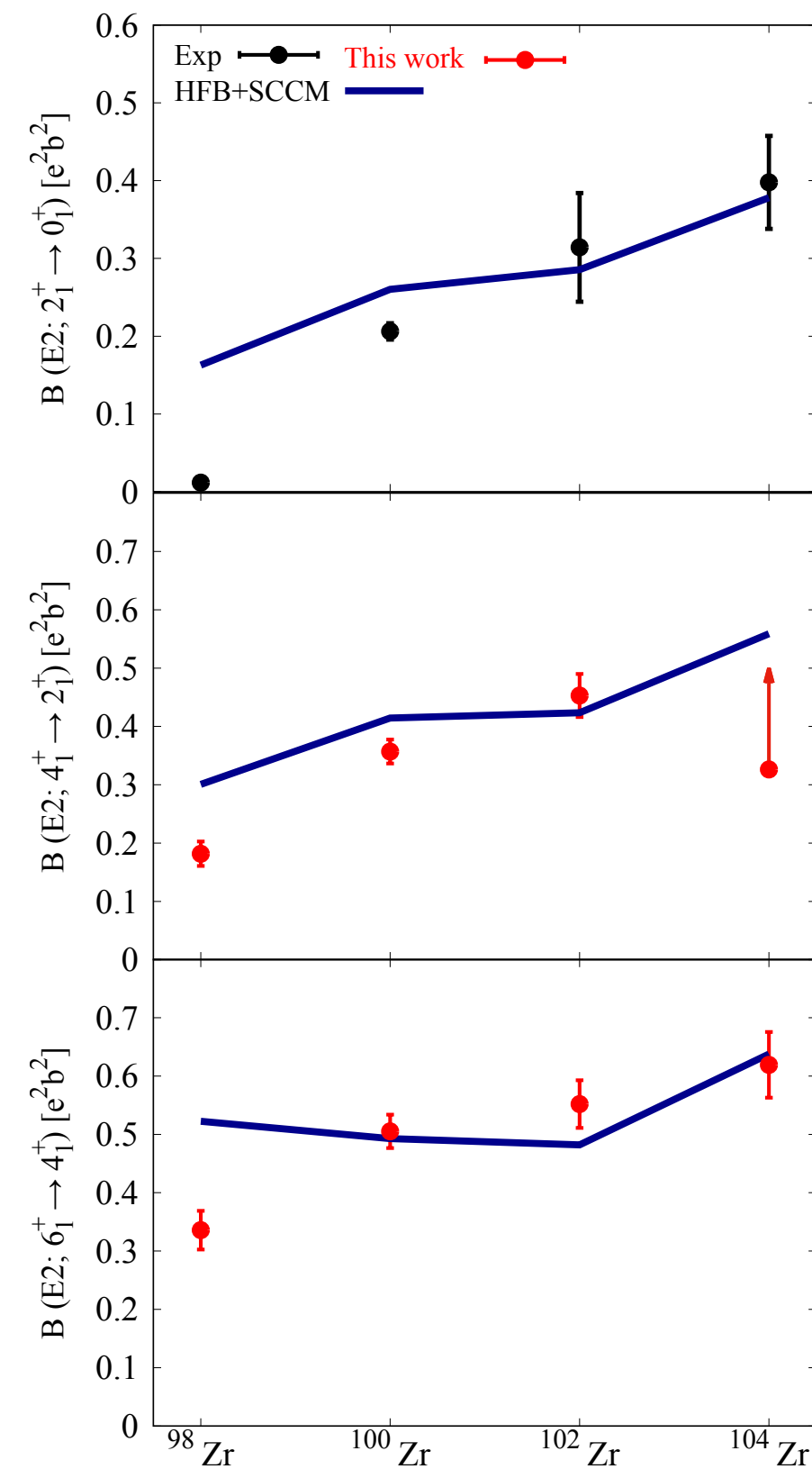

Adapted from S. Ansari PhD thesis

Some physics cases: Spectroscopy of neutron rich Nb isotopes

Nuclear structure of the neutron rich Nb isotopes:
new insights into the sudden onset of deformation of the
 $A \sim 100$ and $N = 60$ region.

M. Abushawish, E. H. Wang, J. Dudouet, O. Stezowski, A. Navin,
S. Bhattacharyya, J. H. Hamilton *et al.*

See talk of **M. Abushawish**
this afternoon in the parallel session

Conclusions and perspectives

Conclusions

- ➔ A large amount of fission data has been taken at GANIL using AGATA and VAMOS++
- ➔ 10 publications on various physics cases (and more to come)

Perspectives

- ➔ New gap in exoticity needs a factor 10 in statistics
- ➔ Will be investigated at LNL using the AGATA/PRISMA



Merci !

