



HAL
open science

Search for a Vector Like Quark T' decaying into quark top and Higgs boson in a dileptonic same sign final state with the CMS experiment at LHC

Benjamin Blancon

► **To cite this version:**

Benjamin Blancon. Search for a Vector Like Quark T' decaying into quark top and Higgs boson in a dileptonic same sign final state with the CMS experiment at LHC. Journées de Rencontre Jeunes Chercheurs 2022, Oct 2022, La Rivière in Saint-Jean-de-Monts, France. in2p3-04908019

HAL Id: in2p3-04908019

<https://in2p3.hal.science/in2p3-04908019v1>

Submitted on 23 Jan 2025

HAL is a multi-disciplinary open access archive for the deposit and dissemination of scientific research documents, whether they are published or not. The documents may come from teaching and research institutions in France or abroad, or from public or private research centers.

L'archive ouverte pluridisciplinaire **HAL**, est destinée au dépôt et à la diffusion de documents scientifiques de niveau recherche, publiés ou non, émanant des établissements d'enseignement et de recherche français ou étrangers, des laboratoires publics ou privés.



Search for a Vector Like Quark T' decaying into quark top and Higgs boson in a dileptonic same sign final state with the CMS experiment at LHC

JRJC, 25 October 2022

Benjamin Blancon

Université Claude Bernard Lyon 1, Institut de Physique des 2 Infinis

Motivation

- In 2012: completion of the Standard Model (SM) with the discovery of Higgs boson.
- Mass of 125 GeV in natural units (n.u.) (~ 130 times the proton mass) problematic because the perturbative corrections make this mass divergent.



→ Hierarchy problem!

→ How do we fix this issue? Adding a new particle in the model!

- **Vector-Like Quark (VLQ) T'** : particle (both quark and vector) whose interaction with the Higgs boson would cancel the corrections and solve the hierarchy problem.
- Higgs boson mass at 125 GeV. → T' mass around 1 TeV (13 TeV in the center of mass of the LHC for 2016-2018). **We assume that the T' mass is 700 GeV.**
- T' is highly unstable: how can we observe it?

T' production

T' single production \rightarrow ?

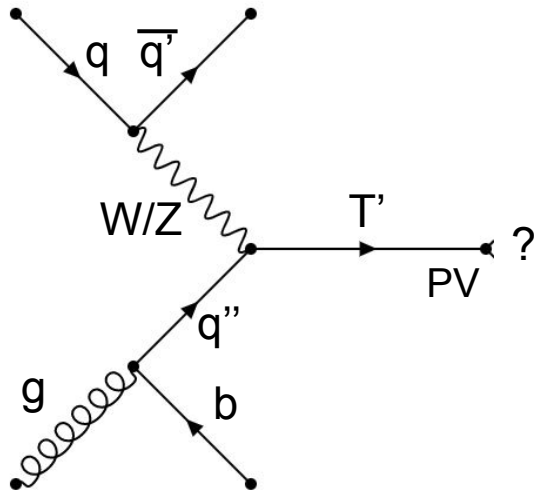

Single T' production:

- quark q -antiquark \bar{q} interaction.
 \rightarrow W/Z boson.
- gluon g -quark b interaction.
 \rightarrow Quark q'' .
- W/Z boson-quark q'' interaction.
 \rightarrow VLQ T'.

At primary vertex (PV), three modes for T' decay:

- T' \rightarrow W boson + top quark (50%).
- T' \rightarrow Z boson + top quark (25%).
- ✓ - T' \rightarrow Higgs boson H + top quark t (25%): most interesting signal!

SHOW
ME MOGETTE



How about the decay of H and t?

T' decay

$$T' \rightarrow H + t \rightarrow ?$$

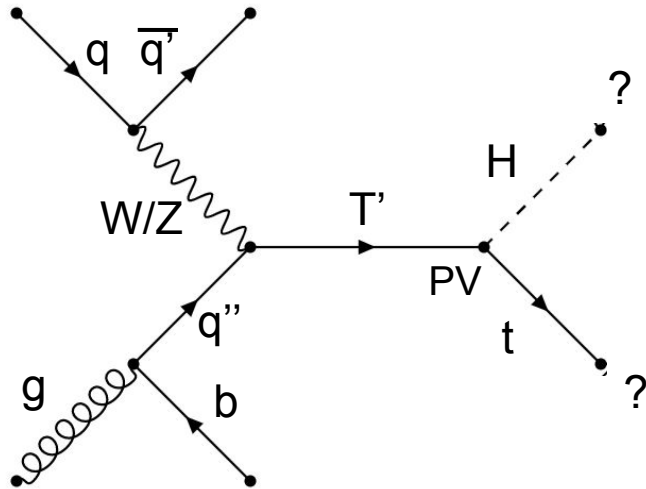

I SAID
MOGETTE



Analysis focused in the dileptonic (electron or muon, not tau) channel:

$H \rightarrow W^- W^+$ bosons (21%).

\rightarrow Lepton l and antineutrino $\bar{\nu}$ (11% per lepton) and two quarks $q''' \bar{q}''''$ (67%).

$t \rightarrow W^-$ boson and quark b (100%).

\rightarrow Lepton l , antineutrino $\bar{\nu}$ (11% per lepton) and quark b .

The leptons have the same sign (SS) in the final state. \rightarrow New starting analysis!

(Ongoing analyses: $H \rightarrow bb$ all hadronic (B2G-18-003 / B2G-19-001), semileptonic (B2G-20-006) and $H \rightarrow \gamma\gamma$ (B2G-21-007) channels.)

Signal final state

$T' \rightarrow$ Dileptonic channel

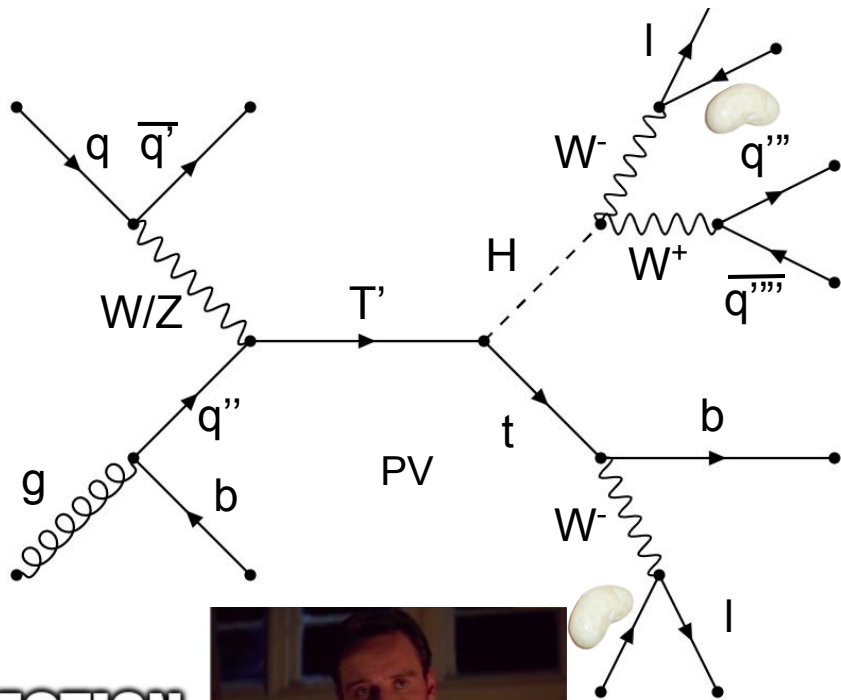

Final state in our signal:

- 2 leptons SS.
- 3 jets coming from 3 quarks (see [Jieun's talk](#)) included 1 jet coming from quark b, e.g. 1 bjet.
- 2 moquettes that we don't detect directly in CMS: we will not consider them.

Three channels considered:

- 2 muons.
- 1 muon + 1 electron.
- 2 electrons.



PERFECTION

So everything is good then...?

Signal vs backgrounds



Of course not! Many other processes have (almost) the same final state!

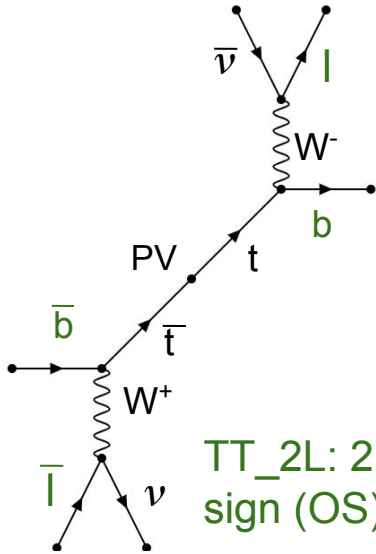

TT_2L: 2 leptons opposite sign (OS) and 2 bjets.

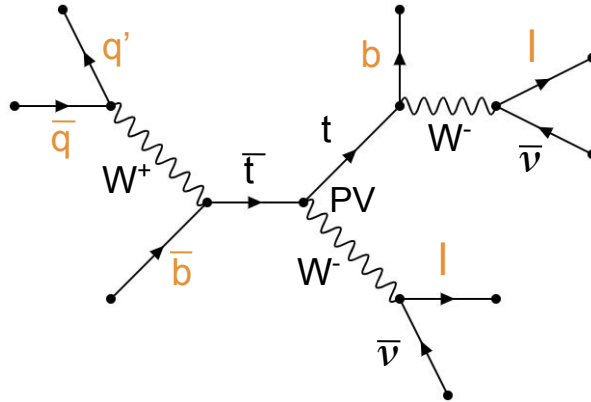

ttW (ttX): 2 leptons SS and 4 jets with 2 bjets.

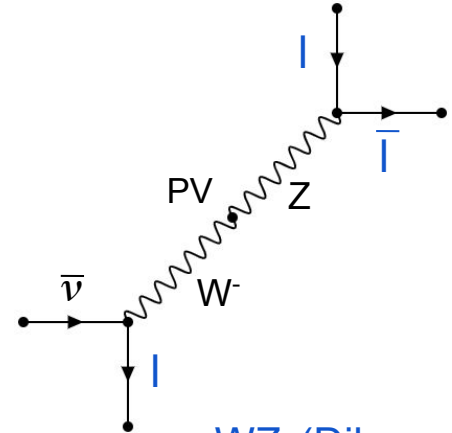

WZ (Diboson): 3 leptons.

A lot of background processes have to be considered (full list in [backup](#)) and we want to discriminate the signal over all of them.

→ Required to design a brand new analysis strategy!

Analysis strategy

Goal \longrightarrow Get the main backgrounds under control!

- **TT_2L**: asking for **SS** leptons.
- **Diboson**: asking for **(b)jets**.
- **ttX**: asking for **one non-hadronic top decay**, e.g. one top decaying in one lepton, one neutrino and one bjet and not in 3 jets.

Determination of background shape thanks to combined fits of Signal Region and Control Regions and extraction of signal shape.

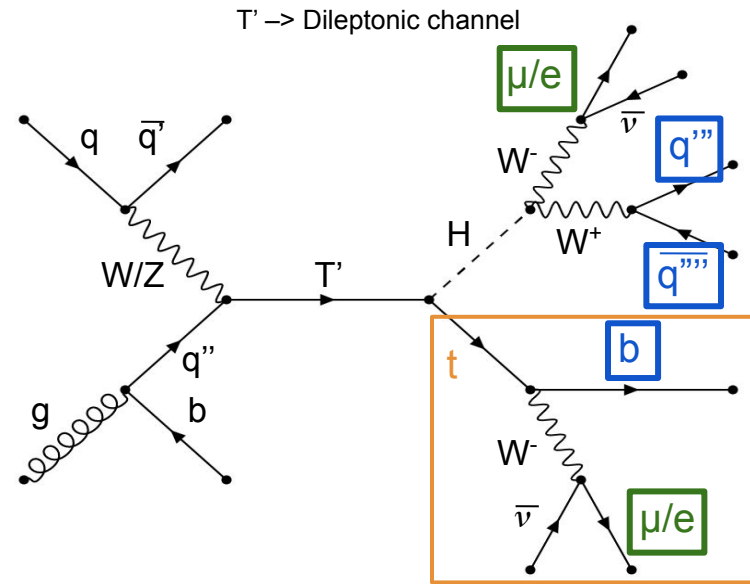

We are working on simulations where the $T' \longrightarrow H+t$ decay has many final states.

\longrightarrow How to make sure that the selection is efficient for the signal?

Generator level

Working on simulated events. \longrightarrow Have access to all the intermediate decays!

We can ask the two leptons SS to come from W bosons. \longrightarrow Generator (Gen) selection (only for the signal!).

Variables of interest:

$$\text{Efficiency } \varepsilon = \frac{\text{Nb}(\text{Gen}+\text{Selection})}{\text{Nb}(\text{Gen})} : \text{how many signal events are selected?}$$

$$\text{Purity } P = \frac{\text{Nb}(\text{Selection}+\text{Gen})}{\text{Nb}(\text{Selection})} : \text{how many selected events are signal events?}$$

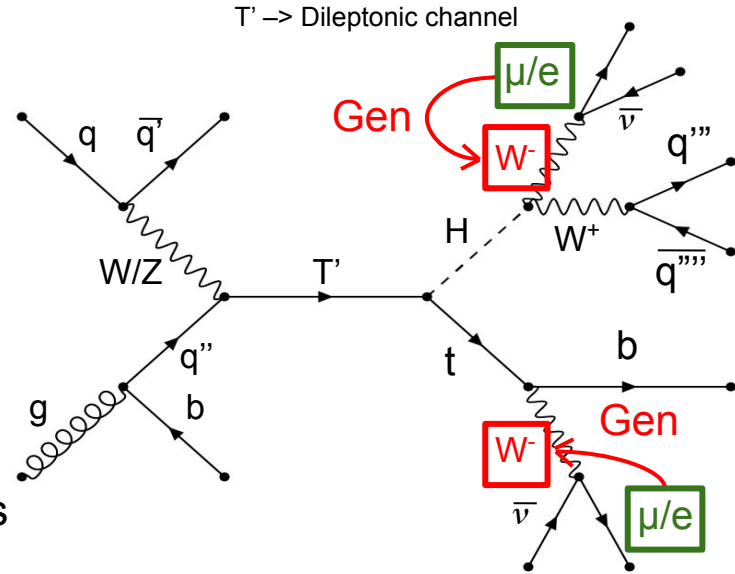

Let's start with lepton identification to remove opposite sign (e.g. TT_{2L} events)!

Lepton identification

Kinematic selection: P_t (transverse momentum) and η (pseudorapidity).

$$\eta = -\ln \left(\tan \left(\frac{\theta}{2} \right) \right)$$

$$\eta = 0 \text{ for } \theta = 90^\circ$$

$$\eta \rightarrow \infty \text{ for } \theta = 0^\circ$$

Muon : $P_t > 20 \text{ GeV}$

$$|\eta| < 2.4 \text{ (} 10.4^\circ \text{)}$$

Electron : $P_t > 25 \text{ GeV}$

$$|\eta| < 2.5 \text{ (} 9.4^\circ \text{)}$$

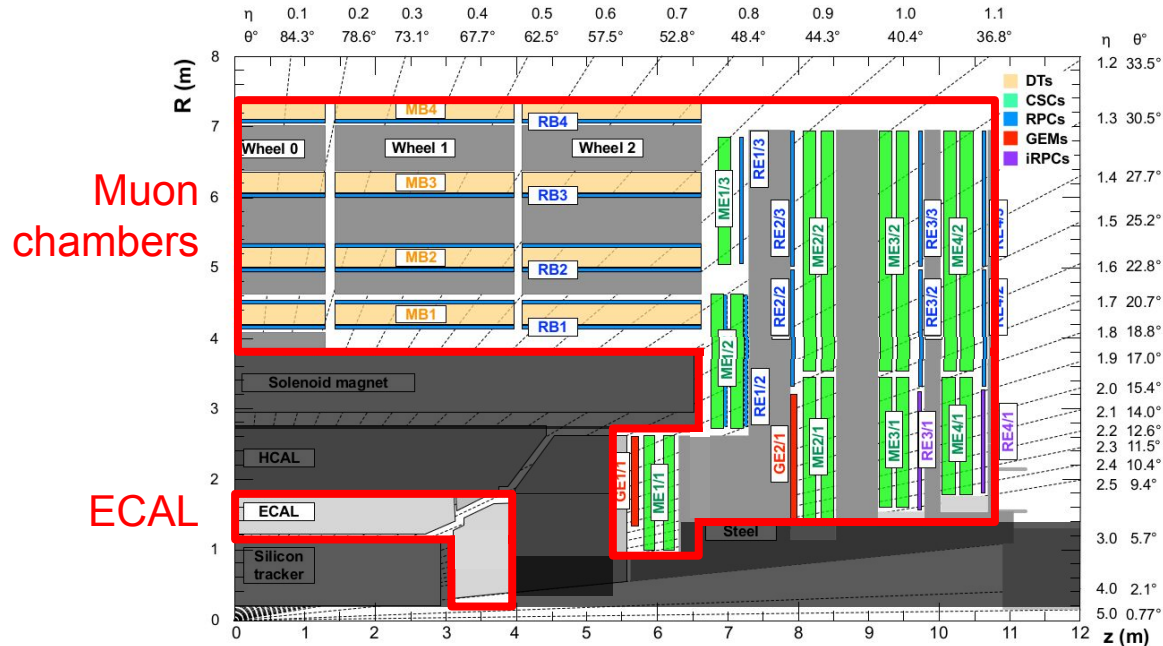

Lepton identification

Variables on study (see [backup](#) for additional variables and studies):

- **Identification (ID)**: based on a global algorithm (Particle Flow) that reconstructs all the particles thanks to the tracks, hits... Three possible values: loose, medium or **tight**. ✓

- **Isolation**: leptons must be outside of jets which can contain fake leptons.

$$\frac{\sum_{R_{\text{iso}}} \text{Pt (Particles-lepton)}}{\text{Pt (lepton)}} < 0.05 \text{ (tight) where } (R_{\text{iso}} = 10 \text{ GeV /Pt (lepton)}) \text{ is the cone size}^1.$$

Pt (lepton)

- **3D Impact parameter significance sip3D**: leptons must be close to the PV.

Muon: sip3D < 3 cm.

Electron: sip3D < 2 cm.

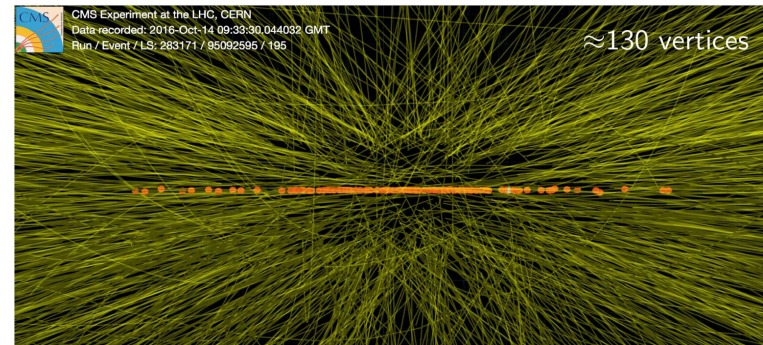

Event reconstruction is a real challenge considering all the tracks and the vertices! ¹⁰

¹: [mini-isolation](#) (Section 4.4.1.)

Object identification - Summary

Muon	Pt > 20 GeV, $ \eta < 2.4$, tight ID, tight isolation, sip3D < 3
Electron	Pt > 25 GeV, $ \eta < 2.5$, tight ID, tight isolation, sip3D < 2
Jet	Pt > 30 GeV, $ \eta < 4.5$, tight ID
B-jet	Pt > 30 GeV, $ \eta < 2.5$, tight ID, medium DeepJet b-tag



Actually I do, Obi-Wan!

Algorithm to identify bjets.
Three values: loose, **medium** or tight.



ID, Isolation and impact parameter significance are crucial for the identification of leptons.

We identify and ask for exactly 2 leptons SS, but we can go further!

Selection criteria - Signal

The T' has a large mass so we expect the 2 leptons to have high P_t .

→ $\sum_{2 \text{ leptons}} P_t > 160 \text{ GeV}$ to reduce **all backgrounds**.

The 2 leptons must be back-to-back.

→ $\Delta R (\text{leptons}) > 1.8$ to reduce **all backgrounds**.

$$\Delta R = \sqrt{(\Delta\eta)^2 + (\Delta\phi)^2}$$

$\Delta R \sim 0$ for leptons next to each other

$\Delta R \gtrsim \pi$ for leptons back to back

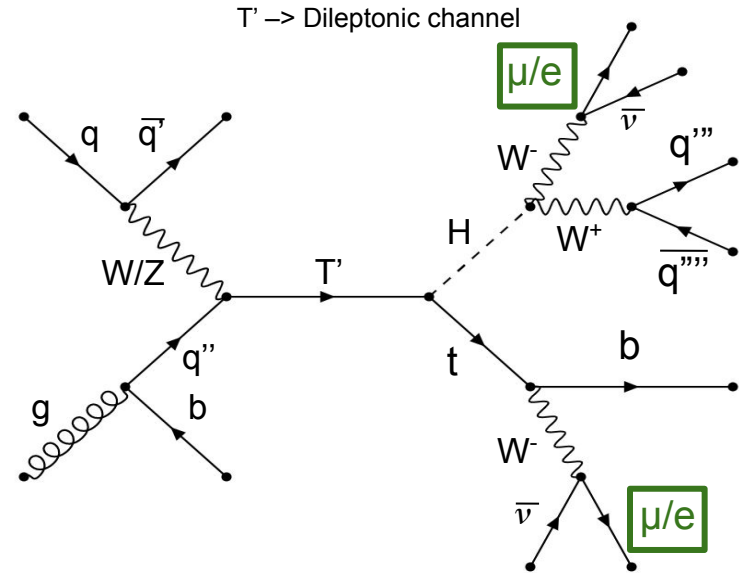

How about the Diboson processes?

Selection criteria - Diboson

We expect 3 jets with 1 b-jet in the final state.
 $\longrightarrow \geq 3$ jets and ≥ 1 b-jet with $P_t > 50$ GeV to reduce
 Diboson backgrounds.

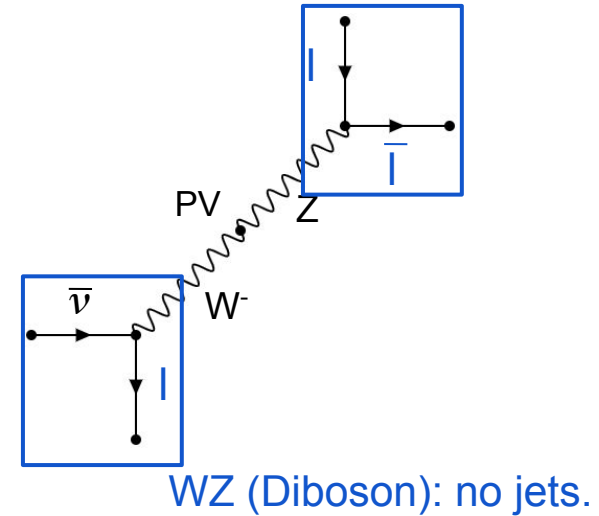

How about the ttX processes?

Selection criteria - ttX

The top must have a non-hadronic decay.

→ $\text{Min}(3 \text{ jets invariant mass} - \text{top invariant mass}) > 34 \text{ GeV}$
(e.g. $3 \text{ jets invariant mass} \notin \text{top invariant mass} \pm 2\sigma^1$) to
reduce **ttX backgrounds**.

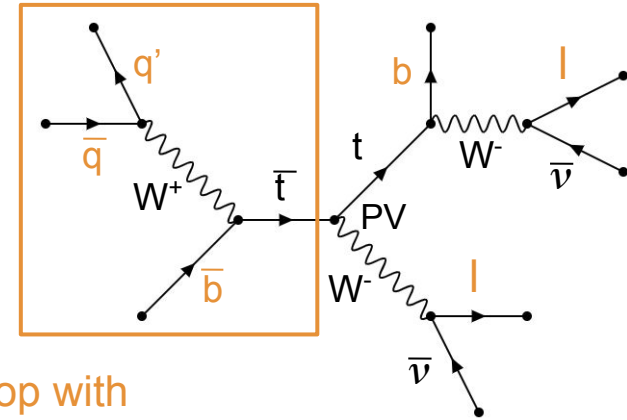

ttW (ttX): one hadronic top with
 \sum invariant mass = top invariant mass
3 jets

¹: [B2G-19-001](#), section 3.2.2

→ Let's see the results of this selection!

Selection criteria - Results

Process	Signal	TT_2L	ttW	ZH	Sum of Bkgs	S/B	
No Cut	1.3E4	1.3E7	9.2E4	6.6E5	1.3E10	0.0001%	- 99.999%
Cut 0 : Sum of Pt of 2 leptons > 160 GeV	19.9	161.1	370.7	2216.0	4620.9	0.43%	- 98.6%
Cut 1 : ≥ 3 jets and ≥ 1 bjet with Pt > 50 GeV	12.4	60.1	248.1	31.7	709.5	1.75%	- 48.6%
Cut 2: Min(3 jets mass - top mass) > 34 GeV	9.6	43.9	127.5	25.6	384.8	2.49%	
Cut 3: ΔR (leptons) > 1.8	9.3	34.1	95.4	14.1	280.1	3.32%	

All the channels are considered. The first cut removes the most background events, etc... The selection is effective (good S/B) but ttW (ttX) remain as the main background.

Main goal: discriminate the signal over the background.
 → Need to find a specific variable!

Main variable

The main variable is the St = Sum of Pt of leptons and jets.
 ttX (53%), TT_SL (25%) and TT_2L (12%) are main backgrounds and the signal is barely visible. \rightarrow Study is ongoing.

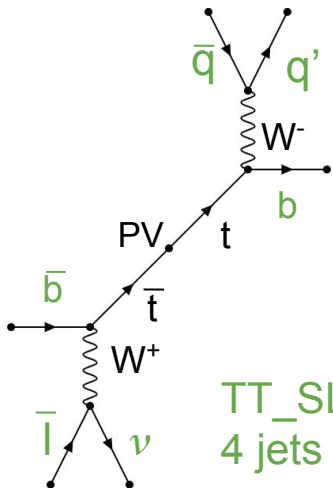

TT_SL : 1 lepton and 4 jets with 2 bjets.

Events/ 30.00

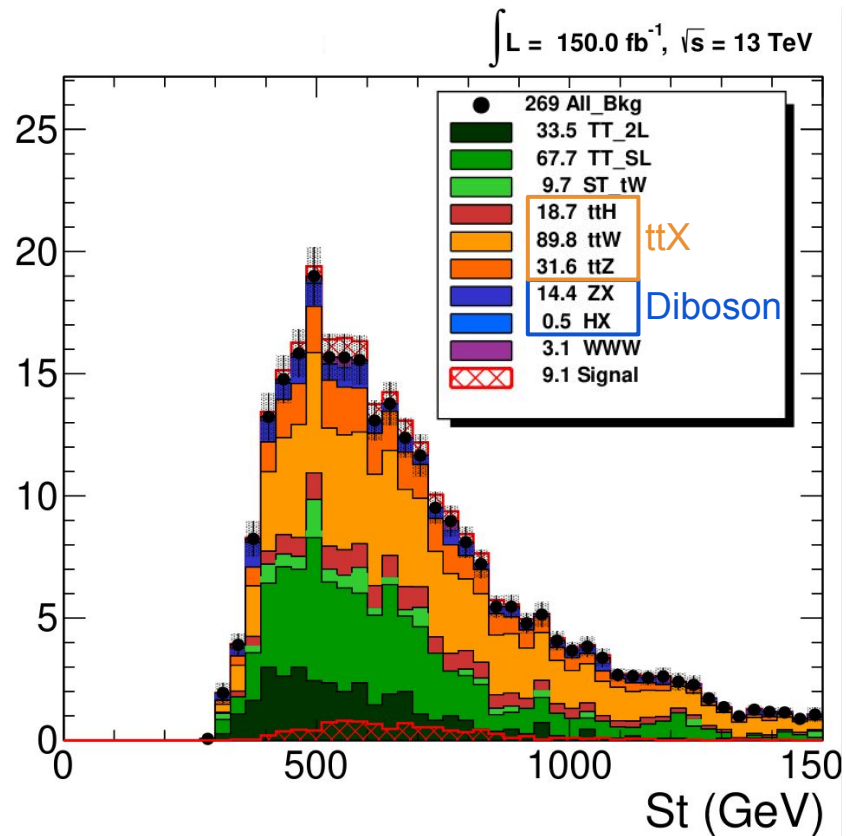

How can we extract the signal?

Control regions

Goal → Define background shape thanks to Control regions (CRs) where backgrounds are pure and apply it to the Signal Region (SR) to extract signal shape.

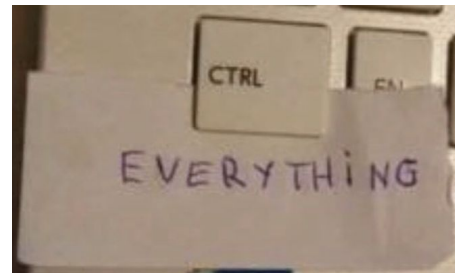

CR 1: first background shape



CR 2: second background shape



...

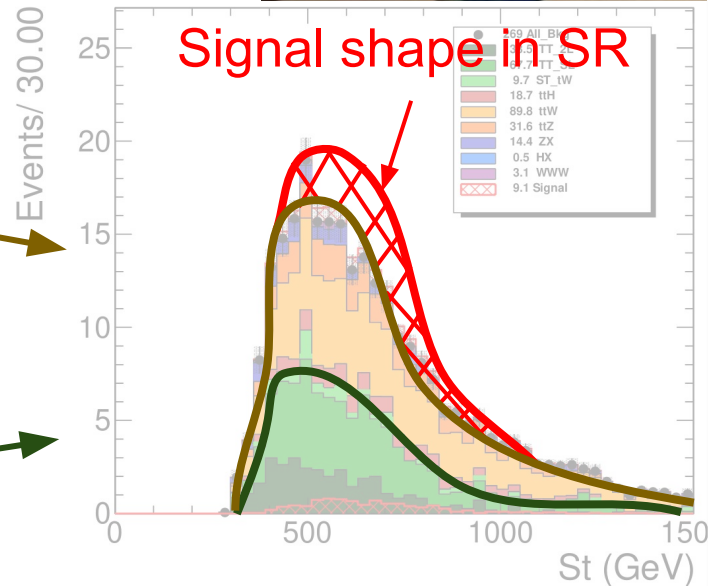

Control regions

Three different shapes for S_t for ttX, TT_SL and TT_2L in the SR.

→ Three CRs by inverting one cut:

- ttX: at least one hadronic top decay.
- TT_2L: two leptons opposite sign.
- TT_SL: ? Study is ongoing. It is not considered.

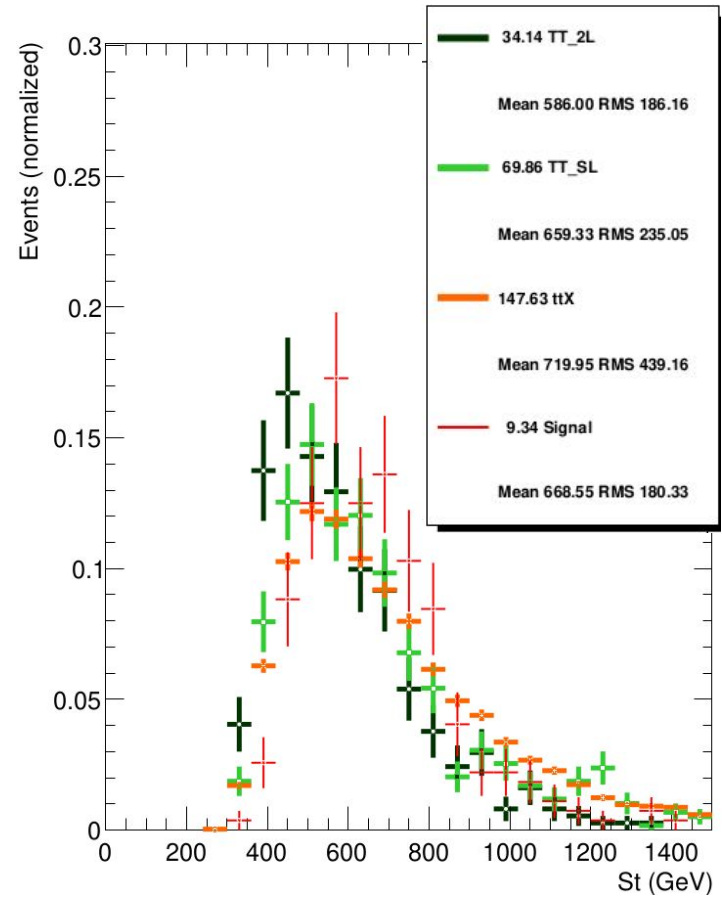
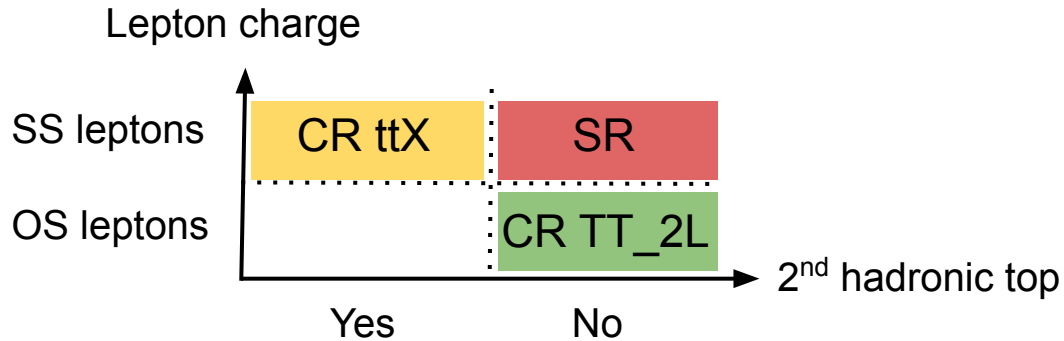

Let's start with the ttX CR!

Control regions - ttX

ttX is the largest background in its CR (63.0%). TT_SL is not negligible (27.6%) but we will not consider it. TT_2L and the signal contamination are negligible.

→ OK!

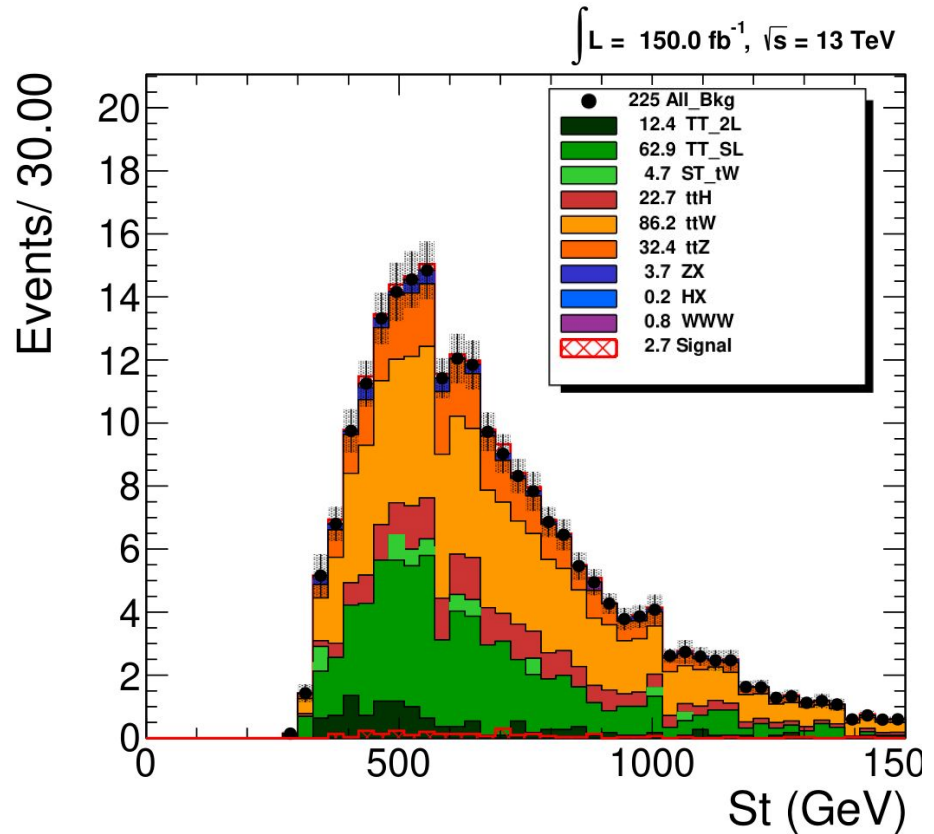

Let's compare the shape with SR!

Control regions - ttX (Validation)

Same shape for ttX in SR and its CR (see separated channels in [backup](#)).

→ Valid method for ttX!

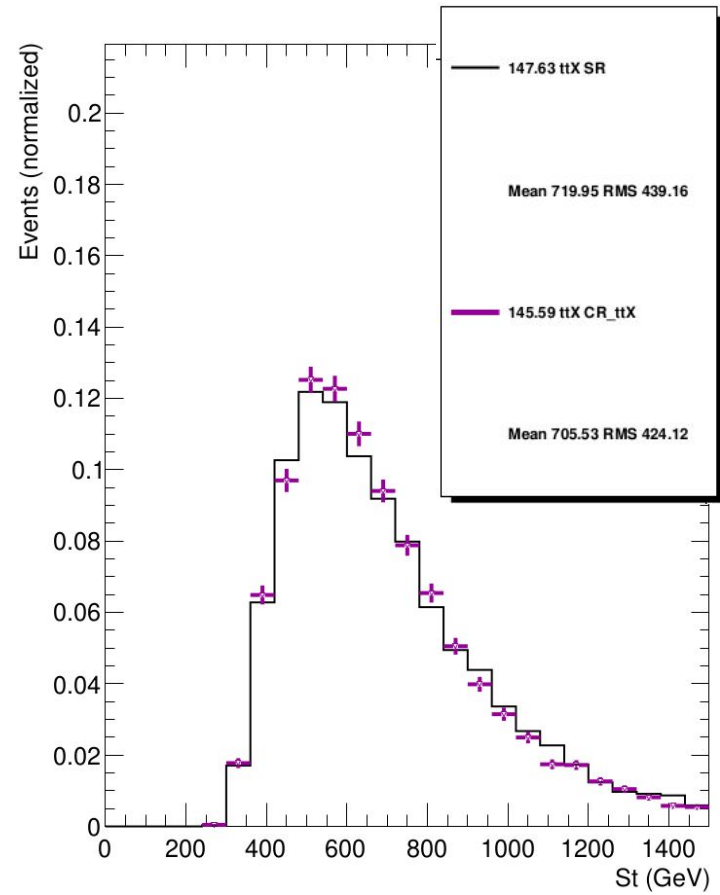

How about the TT_2L CR?

Control regions - TT_2L

TT_2L is the largest background in its CR (92,1%). ttX, TT_SL and the signal contamination are negligible.
→ OK!

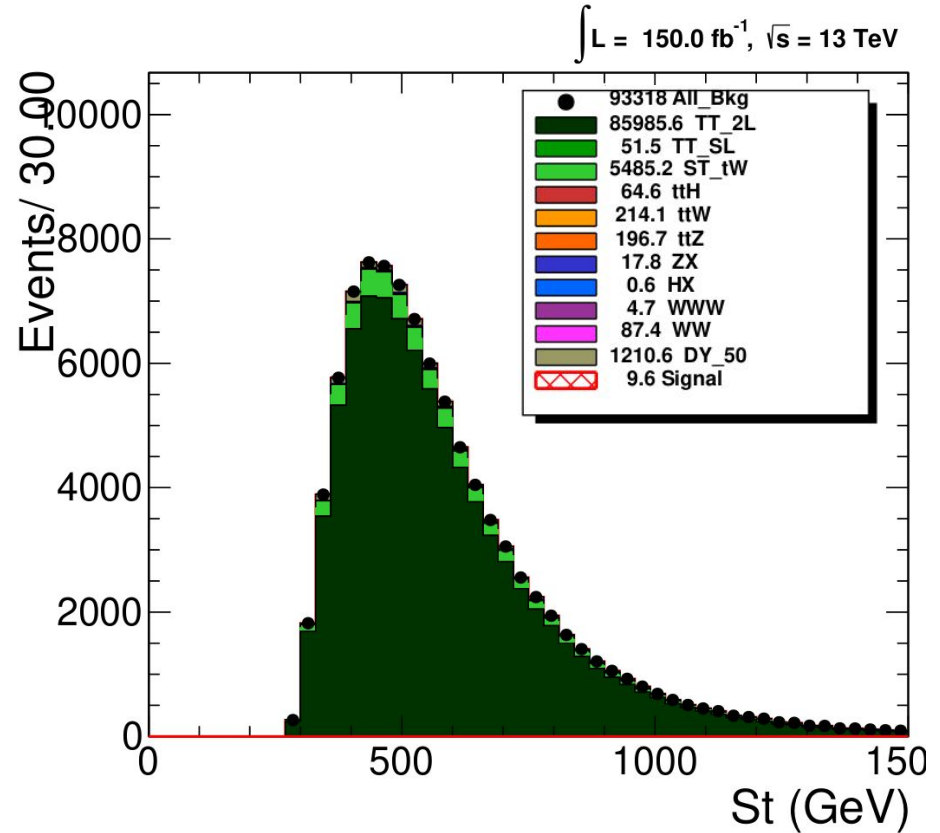

Let's compare the shape with SR!

Control regions - TT_2L (Validation)

Global same shape for TT_2L in the SR and its CR, need more statistics to confirm (see separated channels in [backup](#)).

→ Valid method for TT_2L?!

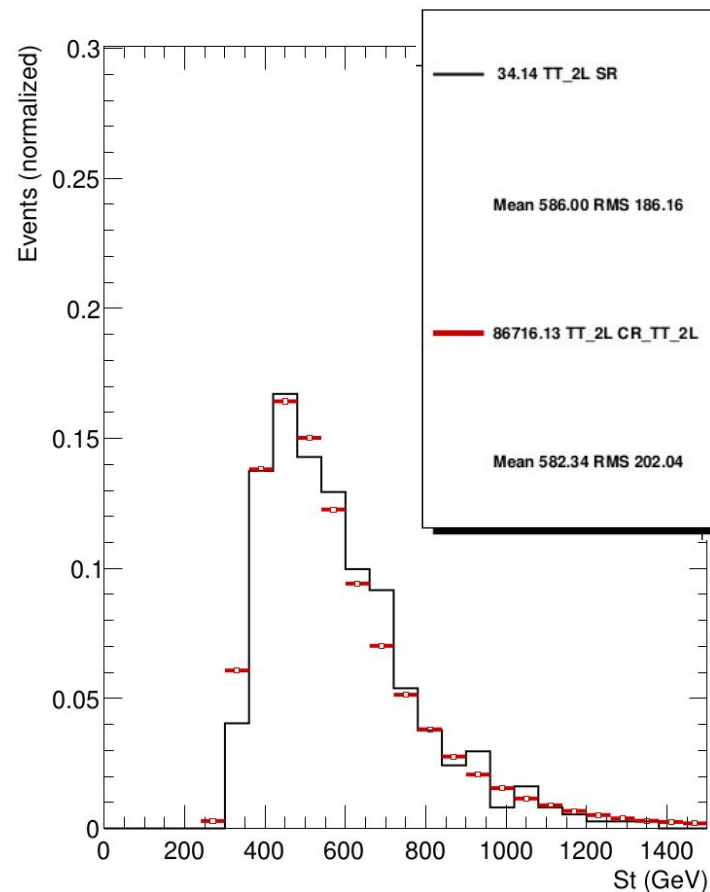

Summary

We focused on T' \longrightarrow top+H dileptonic SS final state analysis.

Analysis strategy designed: multiple studies (lepton identification, cut selection).

Defined CRs for the background estimation method.

Still a lot of things to do (get TT_SL under control, Scale Factors, apply the fit strategy for the background, comparison with the data, paper!)





That's all Folks!

Back-up

Datasets (UL18, Luminosity = 150 fb^{-1})

The backgrounds are ranked as major backgrounds.

1/2

Process	Cross-section (fb)	Number of events	Dataset name
Signal ($M_{\tau} = 700 \text{ GeV}$)	89	400,000	/TprimeBToTH_M-700_LH_TuneCP5_13TeV-madgraph_pythia8/*-v1/NANOAOBSIM
ttbar	87,315	145,020,000	/TTTo2L2Nu_TuneCP5_13TeV-powheg-pythia8/*-v1/NANOAOBSIM
ttW	610.5	27,686,862	/ttWJets_TuneCP5_13TeV_madgraphMLM_pythia8/*-v2/NANOAOBSIM
ttZ	770	32,793,815	/ttZJets_TuneCP5_13TeV_madgraphMLM_pythia8/*-v2/NANOAOBSIM
Single top (tW)	19,467	22,220,050	/ST_tW_antitop_5f_NoFullyHadronicDecays_TuneCP5_13TeV-powheg-pythia8/*-v1/ NANOAOBSIM /ST_tW_top_5f_NoFullyHadronicDecays_TuneCP5_13TeV-powheg-pythia8/*-v1/ NANOAOBSIM
ttH	271	7,328,993	/ttHToNonbb_M125_TuneCP5_13TeV-powheg-pythia8/*-v2/NANOAOBSIM
WZ	4,429.7	9,821,283	/WZTo3LNU_TuneCP5_13TeV-amcatnloFXFX-pythia8/*-v2/NANOAOBSIM

* = RunII Summer20UL18 NanoAODv9-106X_upgrade2018_realistic_v16_L1v1

Datasets (UL18, Luminosity = 150 fb^{-1})

Process	Cross-section (fb)	Number of events	Dataset name
ZZ	1,256	98,488,000	/ZZTo4L_TuneCP5_13TeV_powheg_pythia8/*-v2/NANOADSIM
WWW	208.6	240,000	/WWW_4F_TuneCP5_13TeV-amcatnlo-pythia8/*-v1/NANOADSIM
WH	31.3	19,916,695	/HWminusJ_HToWWTo2L2Nu_WTo2L_M-125_TuneCP5_13TeV-powheg-pythia8/*-v2/NANOADSIM /HWplusJ_HToWWTo2L2Nu_WTo2L_M-125_TuneCP5_13TeV-powheg-pythia8/*-v2/NANOADSIM
ZH	185.8	9,899,256	/HZJ_HToWW_M-125_TuneCP5_13TeV-powheg-jhugen727-pythia8/*-v2/NANOADSIM
WW	12,178	9,994,000	/WWTo2L2Nu_TuneCP5_13TeV-powheg-pythia8/*-v2/NANOADSIM
Drell-Yan	18,610,000 (10-50 GeV)	94,452,816	/DYJetsToLL_M-10to50_TuneCP5_13TeV-madgraphMLM-pythia8/*-v1/NANOADSIM
	6,020,850 (50 GeV)	96,233,328	/DYJetsToLL_M-50_TuneCP5_13TeV-madgraphMLM-pythia8/*-v1/NANOADSIM
W+Jets	61,334,900	81,051,269	/WJetsToLNu_TuneCP5_13TeV-madgraphMLM-pythia8/*-v1/NANOADSIM

* = RunII Summer20UL18 NanoAODv9-106X_upgrade2018_realistic_v16_L1v1

Events number scaling

Interaction probability for a given particle for a given reaction (fb)

Number of raw events after selection

Number of scaled events =

Number of raw events before selection

*Cross section*Luminosity

Number of collisions detected by CMS
(fb⁻¹, 137 fb⁻¹ between 2016 and 2018)

Acceptance and efficiency are set to 1 (for the moment!).

Muon identification



List of additional studied variables:

- Phi.
- 3D impact parameter ip3d.
- Mini PF relative charged isolation = Pt of muon / $\sum_{R_{iso}}$ (Pt of all charged particles): loose < 0.10, tight < 0.05¹.
- PF relative 0.3 isolation = $\sum_{R=0.3}$ (Pt of charged hadrons - Max(0, Pt of neutral hadrons and photons - PU/2)) / Pt of muon:
loose < 0.10, tight < 0.05².
- PF relative 0.3 charged isolation = $\sum_{R=0.3}$ (Pt of charged hadrons) / Pt of muon: loose < 0.10, tight < 0.05².
- PF relative 0.4 isolation = $\sum_{R=0.4}$ (Pt of charged hadrons - Max(0, Pt of neutral hadrons and photons - PU/2)) / Pt of muon:
loose < 0.25, tight < 0.15².

¹: [mini-isolation](#) (Section II.A.), ²: [isolation](#) (Section 3.5.)

Muon identification - 2μ channel

ID	Isolation	Sip3D	Signal	ϵ Signal (%)	P Signal (%)	ttbar	ttW	WZ	S/B	
Loose	Nothing	Nothing	41.0	60.9	35.7	26632.0	728.4	4484.1	0.13%	
	Loose	Nothing	27.0	52.0	46.5	6550.1	584.9	4168.7	0.24%	
	Tight	Nothing	23.6	47.4	48.7	4139.4	520.1	3712.3	0.28%	
Medium	Nothing	Nothing	38.7	60.4	37.5	24082.3	705.5	4344.5	0.13%	
	Loose	Nothing	25.4	51.6	49.1	4575.9	566.9	4043.7	0.28%	
	Tight	Nothing	22.1	47.0	51.4	2432.3	504.5	3603.1	0.34%	
Tight	Nothing	Nothing	37.2	58.1	37.8	23025.9	681.1	4205.5	0.13%	
	Loose	Nothing	24.3	49.3	49.3	4291.6	548.0	3919.0	0.28%	
	Tight	Nothing	Nothing	21.2	45.3	52.1	2250.2	487.8	3494.3	0.34%
		<10	Nothing	19.6	45.2	56.1	1310.2	475.9	3419.9	0.38%
		<5	Nothing	17.7	44.1	62.2	790.4	454.9	3219.9	0.40%
<3	Nothing	15.7	42.2	70.9	484.0	417.1	2891.8	0.41%		



Electron identification

List of additional studied variables:

- Same variables as for muons.
- $\Delta\eta$ between SuperCluster and electron.
- Non-PF 0.3 ECAL isolation.
- Non-PF 0.3 HCAL isolation.
- Non-PF 0.3 track isolation.
- Non-PF 0.3 track isolation with HEEP ID.
- WP 80 MVA isolation ID.
- TTH MVA lepton ID.

Electron identification - $1\mu+1e$ channel

ID	Isolation	Sip3D	Signal	ϵ Signal (%)	P Signal (%)	ttbar	ttW	WZ	S/B
Tight	Tight	<3	20.6	27.1	64.1	2373.5	566.3	6724.2	0.21%
		<2	17.5	23.7	66.0	1623.8	494.4	6227.3	0.21%
HEEP		<3	20.3	25.2	64.6	3151.1	527.4	6149.2	0.21%
		<2	17.0	22.2	66.7	2148.8	458.1	5614.0	0.21%



Electron identification - $1\mu+1e$ channel

List of variables for ttH AN:

- $Pt > 25 \text{ GeV}$, $|\eta| < 2.5$, loose ID, isolation < 0.40 , sip3D < 8 .
- Transverse impact parameter d_{xy} of electron < 0.05 .
- Longitudinal impact parameter d_z of electron < 0.1 .
- $\sigma_{\eta\eta}$ of electron < 0.011 in barrel ($|\eta| < 1.479$) and < 0.03 in endcap ($|\eta| > 1.479$).
- $\frac{\text{Electron energy}_{\text{HCAL}}}{1} < 0.1$.
- $\frac{\text{Electron energy}_{\text{ECAL}}}{1} - \frac{1}{Pt_{\text{tracker}}} < -0.04$.
- Electron energy ECAL
- Number of missing hits = 0.
- Loose MVA isolation ID.

	Signal	ϵ Signal (%)	P Signal (%)	ttbar	ttW	WZ	S/B
Study ttH AN	2.7	2.9	53.7	1668.2	64.8	835.3	0.11%

Selection criteria

List of additional studied variables:

- Pt of 1st and 2nd lepton.
- Pt of sum of the two leptons.
- $\Delta\phi$ between the two leptons.
- Mass of sum of the two leptons.
- Pt of 1st, 2nd and 3rd jet and 1st b-jet.
- Ht = Sum of Pt of the jets.

Selection criteria - Signal

The T' has a large mass so we expect the 2 leptons to have high P_t (Gen selection for the signal).

→ Cut 0: $\sum_{2 \text{ leptons}} P_t > 160 \text{ GeV}$ to reduce **all the backgrounds**.

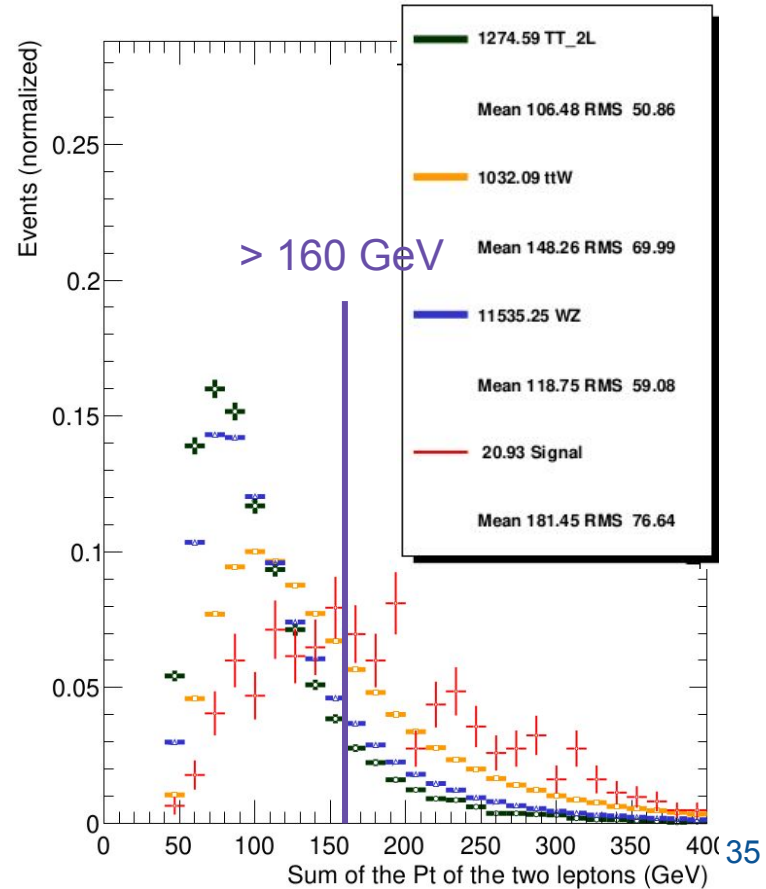
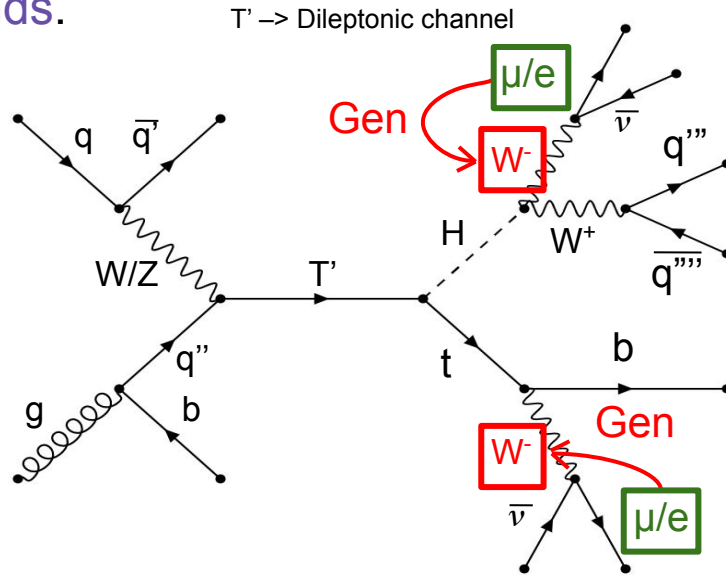

Selection criteria - Diboson

We expect 3 jets with 1 b-jet in the final state.

→ Cut 1: ≥ 3 jets and ≥ 1 b-jet with $P_t > 50$ GeV to reduce Diboson backgrounds.

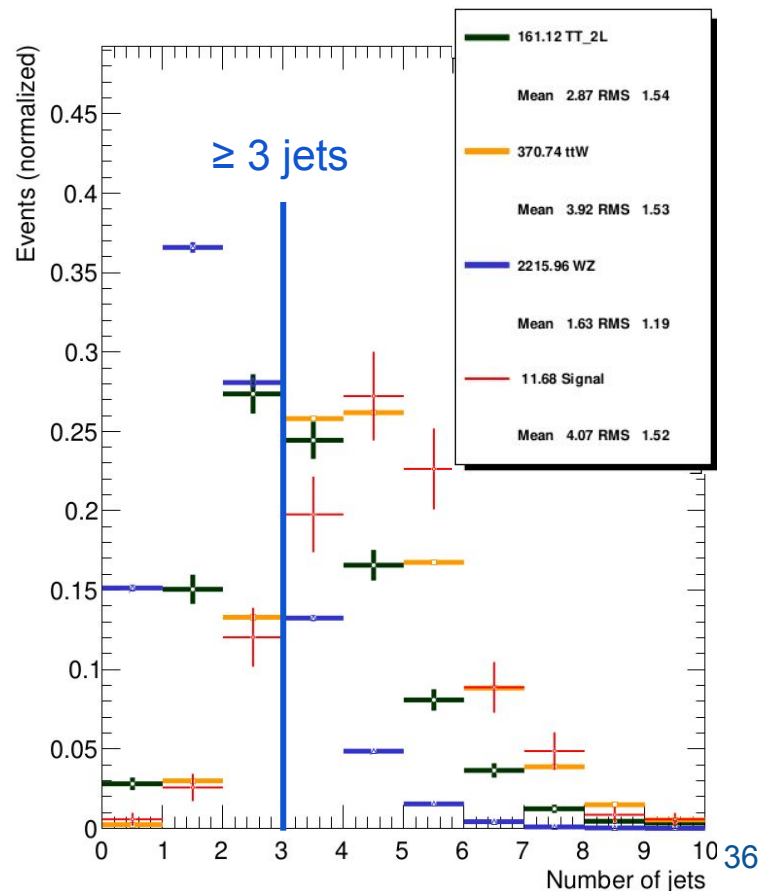
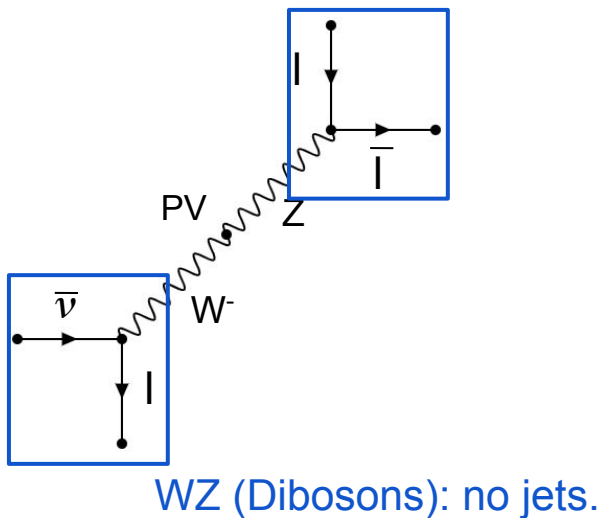

Selection criteria - Diboson

We expect 3 jets with 1 b-jet in the final state.

→ Cut 1: ≥ 3 jets and ≥ 1 b-jet with $P_t > 50$ GeV to reduce Diboson backgrounds.

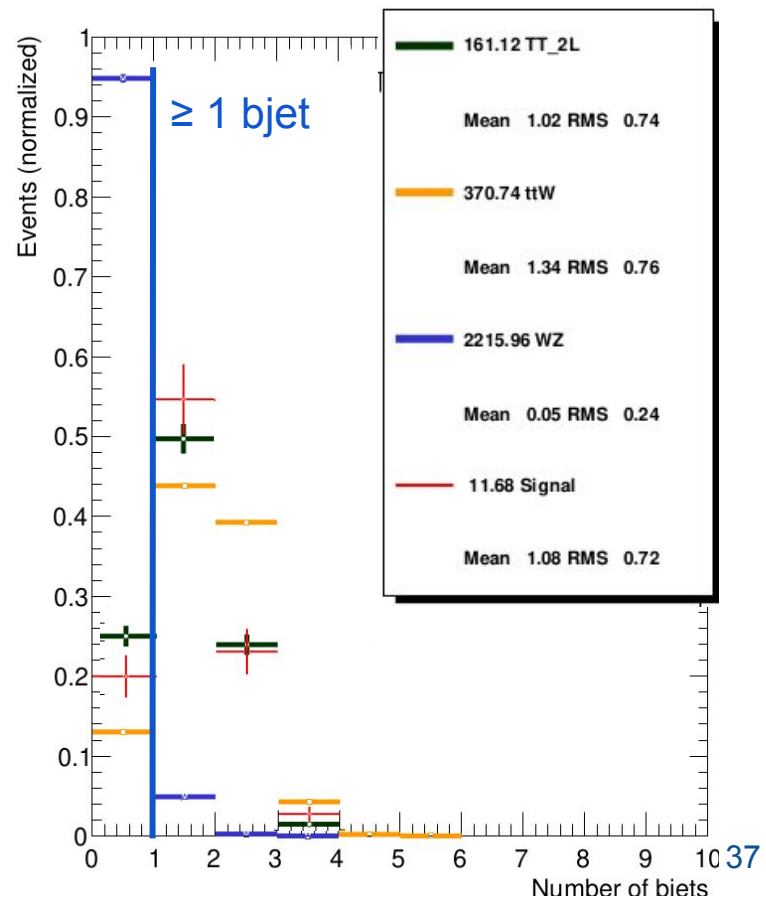
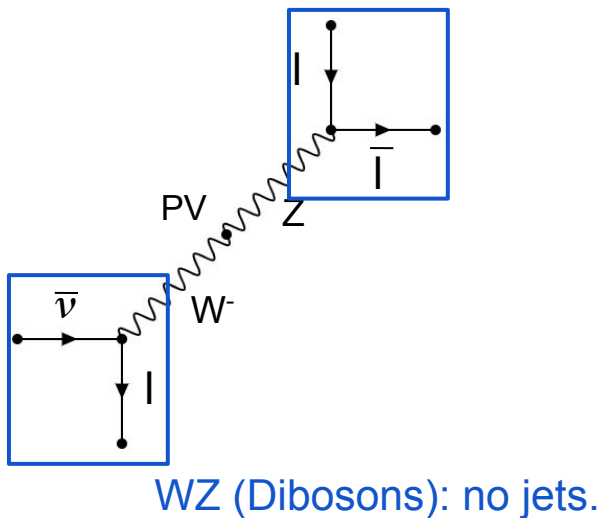

Selection criteria - ttX

The top must have a non-hadronic decay.

→ Cut 2: $\text{Min}(3 \text{ jets invariant mass} - \text{top invariant mass}) > 34 \text{ GeV}$ (i.e. $3 \text{ jets invariant mass} \notin \text{top invariant mass} \pm 2\sigma^1$) to reduce **ttX backgrounds**.

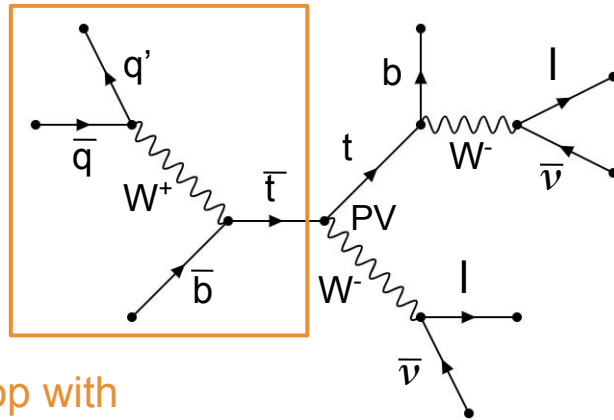

ttW (ttX): one hadronic top with
 \sum invariant mass = top invariant mass
 3 jets

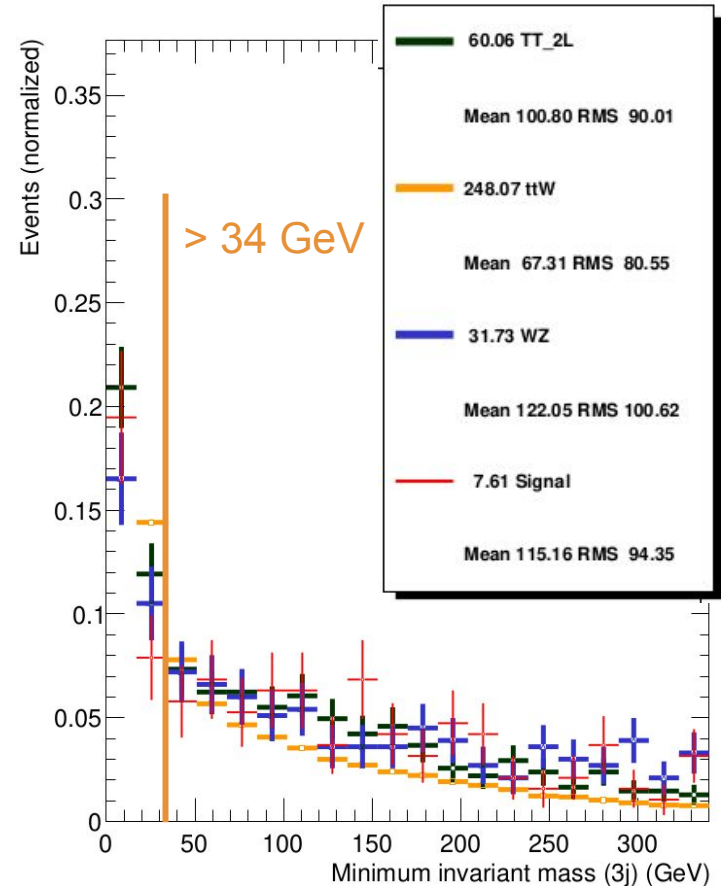

¹: [B2G-19-001](#), section 3.2.2

Selection criteria - Signal

The 2 leptons must be back-to-back.
 → Cut 3: ΔR (leptons) > 1.8 to reduce **all the backgrounds**.

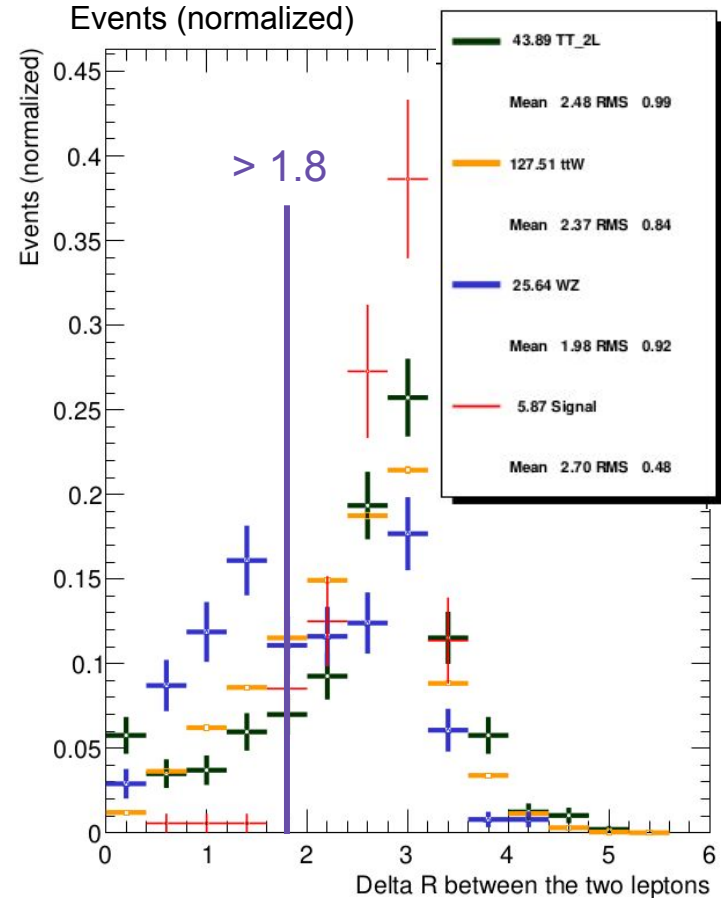

Selection criteria - All channels results

Process	Signal	ϵ signal (%)	P signal (%)	TT_2L	ttW	WZ	S/B
Cut 0	19.9	14.4	65.2	161.1	370.7	2216.0	0.72%
Cut 1	12.4	9.4	68.9	60.1	248.1	31.7	3.65%
Cut 2	9.6	7.3	67.4	43.9	127.5	25.6	4.87%
Cut 3	9.3	7.1	66.9	34.1	95.4	14.1	6.47%

Selection criteria - All channels results

Process	Signal	ttW	TT_SL	TT_2L	ttZ	ttH	ZX*	Single top (tW)	WWW	HX*	Others*	Sum of Bkgs	S/B
Cut 0	19.9	370.7	336.6	161.1	132.8	86.8	2341.6	58.1	91.0	89.3	952.8	4620.9	0.43%
Cut 1	12.4	248.1	181.6	60.1	92.6	63.8	33.2	24.7	4.3	1.0	0.2	709.5	1.75%
Cut 2	9.6	127.5	91.0	43.9	45.6	29.1	26.7	16.5	3.5	0.8	0.2	384.8	2.49%
Cut 3	9.3	95.4	69.9	34.1	32.6	19.6	14.9	10.0	3.1	0.5	0.0	280.1	3.32%

* ZX = ZW + ZZ

HX = HW + HZ

Others = WW, Drell-Yan and W+Jets

Selection criteria - 2μ channel results

Process	Signal	ϵ signal (%)	P signal (%)	TT_2L	ttW	WZ	S/B
Cut 0	8.2	22.5	65.4	36.7	145.0	412.9	1.38%
Cut 1	5.1	14.7	69.1	14.3	98.2	6.2	4.30%
Cut 2	4.1	12.3	72.1	10.7	50.9	5.1	6.15%
Cut 3	4.0	12.1	72.5	8.7	38.4	2.4	8.08%

Selection criteria - 2μ channel results

Process	Signal	ttW	TT_SL	TT_2L	ttZ	ttH	ZX*	Single top (tW)	WWW	HX*	Others*	Sum of Bkgs	S/B
Cut 0	8.2	145.0	138.2	36.7	22.6	35.8	425.5	16.6	33.5	32.3	236.4	1122.6	0.73%
Cut 1	5.1	98.2	71.8	14.3	15.9	26.6	6.3	5.8	1.6	0.4	0.0	240.8	2.12%
Cut 2	4.1	50.9	35.0	10.7	7.9	12.0	5.2	3.1	1.3	0.3	0.0	126.4	3.24%
Cut 3	4.0	38.4	30.9	8.7	5.6	8.1	2.4	2.3	1.3	0.2	0.0	97.9	4.09%

* ZX = ZW + ZZ

HX = HW + HZ

Others = WW, Drell-Yan and W+Jets

Selection criteria - $1\mu+1e$ channel results

Process	Signal	ϵ signal (%)	P signal (%)	TT_2L	ttW	WZ	S/B
Cut 0	9.2	13.9	70.0	83.6	174.1	1194.6	0.63%
Cut 1	5.8	9.2	73.0	31.3	116.0	16.4	3.54%
Cut 2	4.4	6.7	70.5	22.7	59.5	13.2	4.61%
Cut 3	4.2	6.3	70.1	17.1	44.4	7.2	6.11%

Selection criteria - $1\mu+1e$ channel results

Process	Signal	ttW	TT_SL	TT_2L	ttZ	ttH	ZX*	Single top (tW)	WWW	HX*	Others*	Sum of Bkgs	S/B
Cut 0	9.2	174.1	156.4	83.6	74.6	40.2	1247.2	31.3	44.3	43.2	271.1	2166.1	0.43%
Cut 1	5.8	116.0	84.8	31.3	52.0	29.4	17.0	13.7	2.1	0.5	0.2	347.0	1.67%
Cut 2	4.4	59.5	43.6	22.7	25.5	13.6	13.6	9.5	1.7	0.4	0.2	190.0	2.32%
Cut 3	4.2	44.4	30.5	17.1	18.4	9.2	7.5	5.8	1.3	0.3	0.0	134.5	3.12%

* ZX = ZW + ZZ

HX = HW + HZ

Others = WW, Drell-Yan and W+Jets

Selection criteria - 2e channel results

Process	Signal	ϵ signal (%)	P signal (%)	TT_2L	ttW	WZ	S/B
Cut 0	2.5	6.8	60.2	40.8	51.7	608.5	0.35%
Cut 1	1.6	4.3	64.6	14.5	33.8	9.2	2.78%
Cut 2	1.1	2.9	59.7	10.5	17.2	7.4	3.13%
Cut 3	1.1	2.8	58.0	8.4	12.6	4.5	4.31%

Selection criteria - 2e channel results

Process	Signal	ttW	TT_SL	TT_2L	ttZ	ttH	ZX*	Single top (tW)	WWW	HX*	Others*	Sum of Bkgs	S/B
Cut 0	2.5	51.7	42.0	40.8	35.6	10.8	668.8	10.2	13.2	13.8	445.3	1332.2	0.19%
Cut 1	1.6	33.8	25.0	14.5	24.7	7.8	9.9	5.3	0.7	0.1	0.0	121.7	1.31%
Cut 2	1.1	17.2	12.4	10.5	12.2	3.5	7.9	3.9	0.5	0.1	0.0	68.1	1.62%
Cut 3	1.1	12.6	8.5	8.4	8.6	2.3	4.9	1.8	0.5	0.1	0.0	47.7	2.31%

* ZX = ZW + ZZ

HX = HW + HZ

Others = WW, Drell-Yan and W+Jets

Main variable - Separated channels

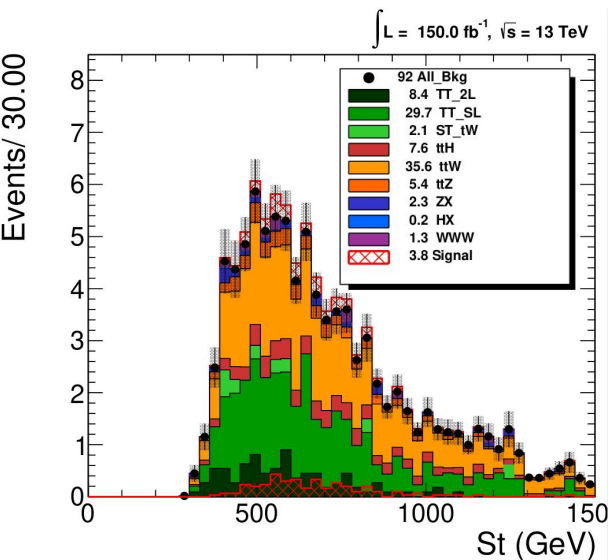

2 μ channel

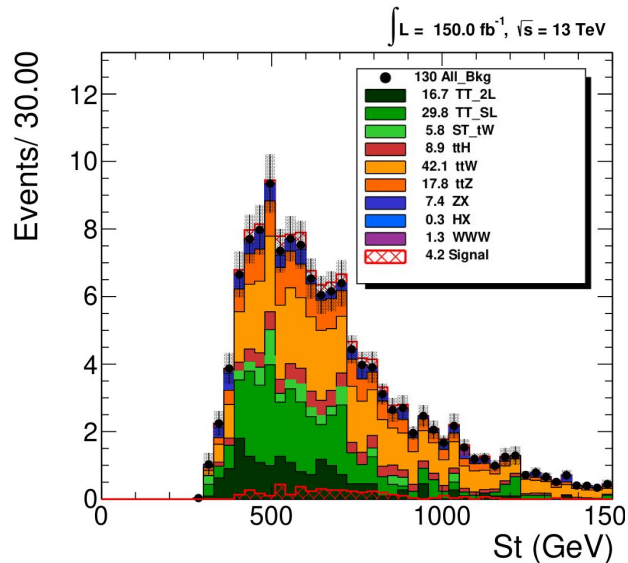

1 μ +1e channel

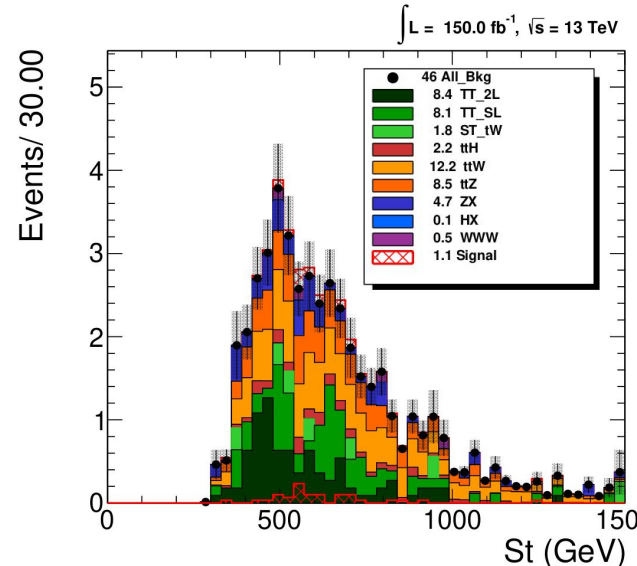

2e channel

Main variable - $\Delta\phi$

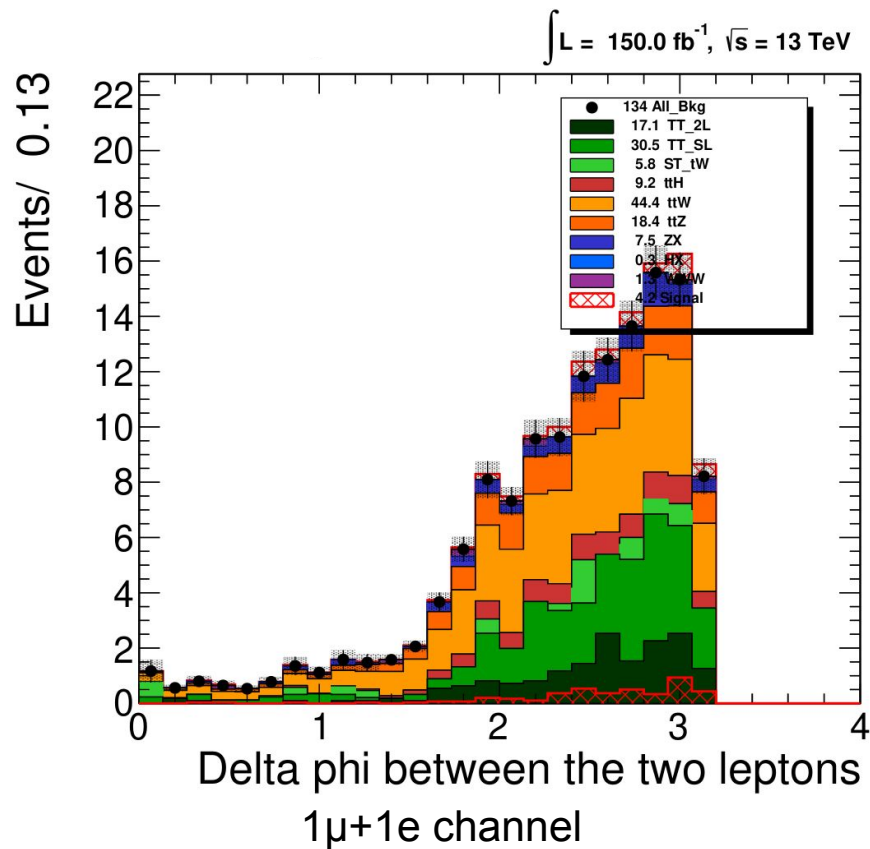
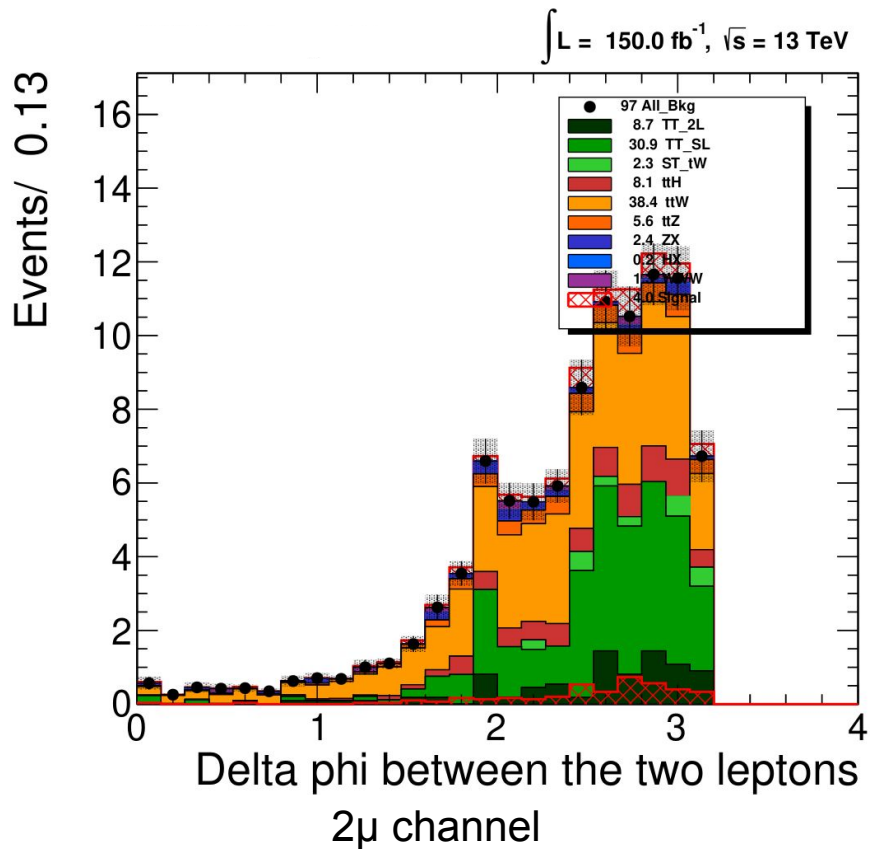

Main variable - $\Delta\phi$

Events/ 0.13

$\int L = 150.0 \text{ fb}^{-1}, \sqrt{s} = 13 \text{ TeV}$

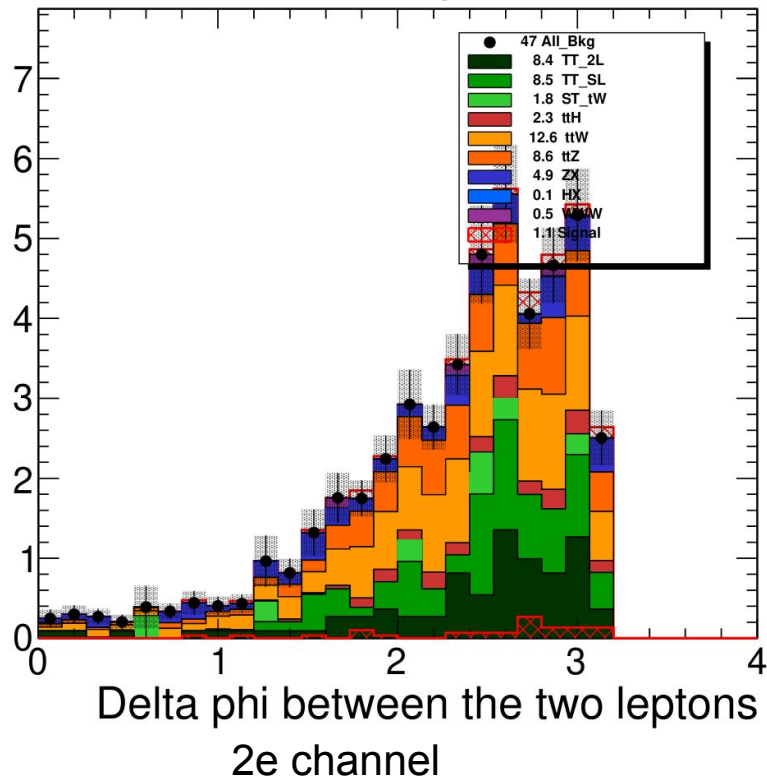

Events/ 0.13

$\int L = 150.0 \text{ fb}^{-1}, \sqrt{s} = 13 \text{ TeV}$

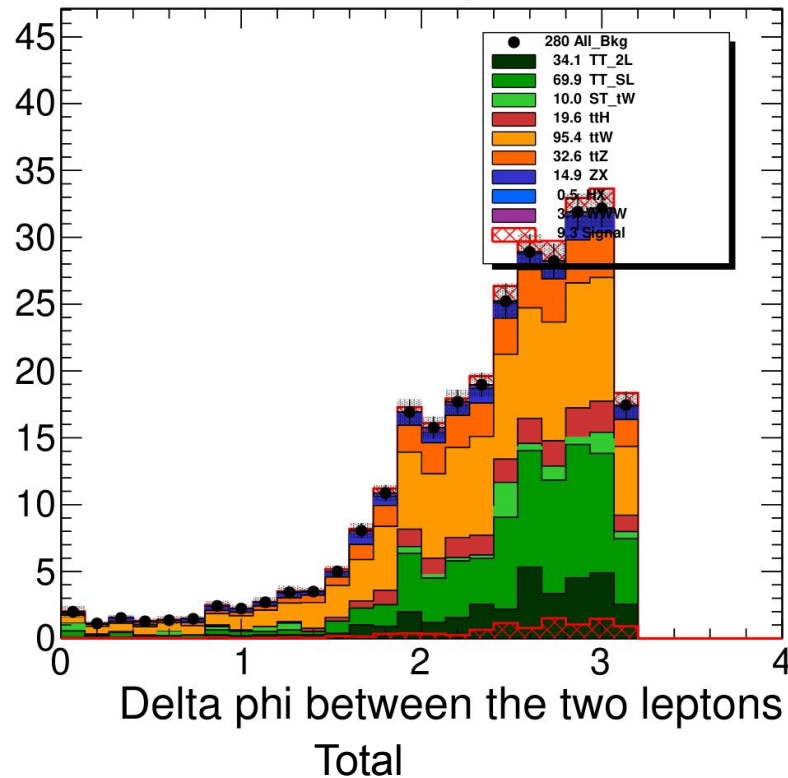

Control regions vs Signal region (ttH)

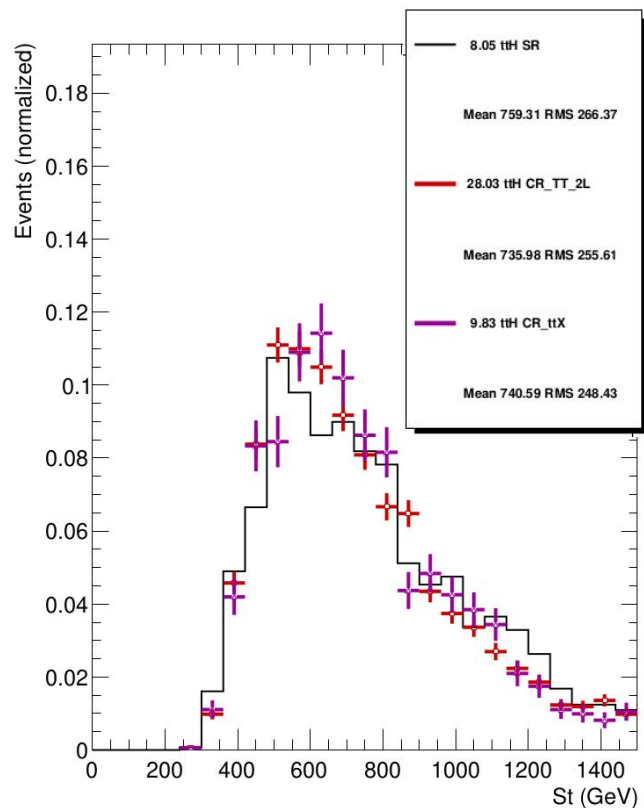

2 μ channel

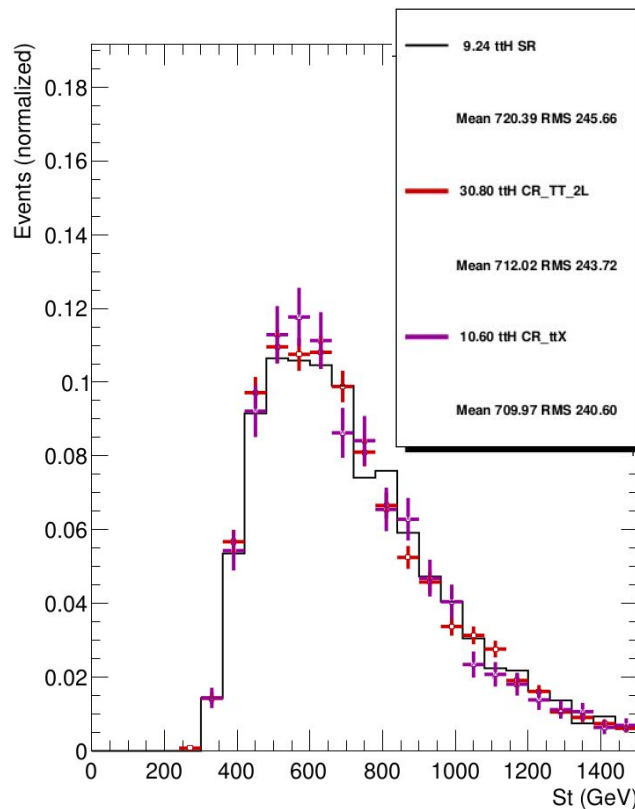

1 μ +1e channel

Control regions vs Signal region (ttH)

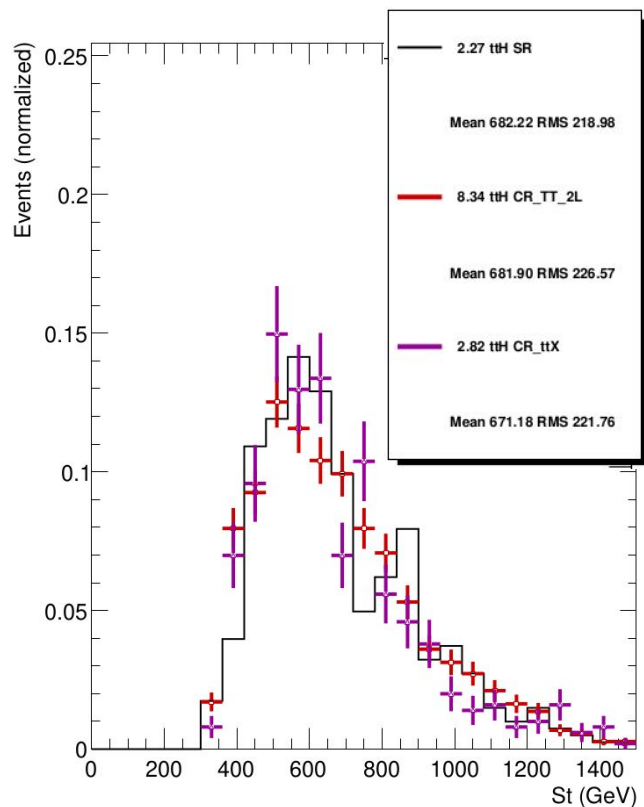

2e channel

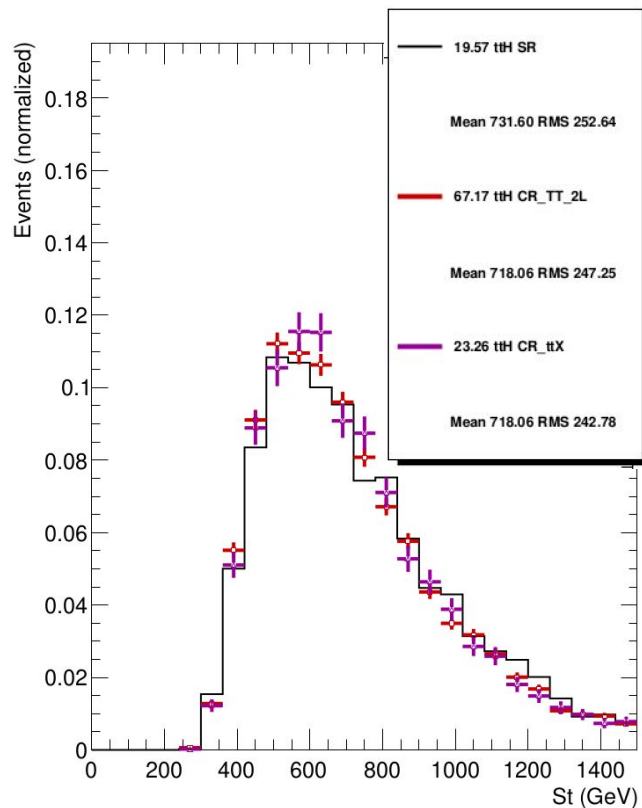

Total

Control regions vs Signal region (ttW)

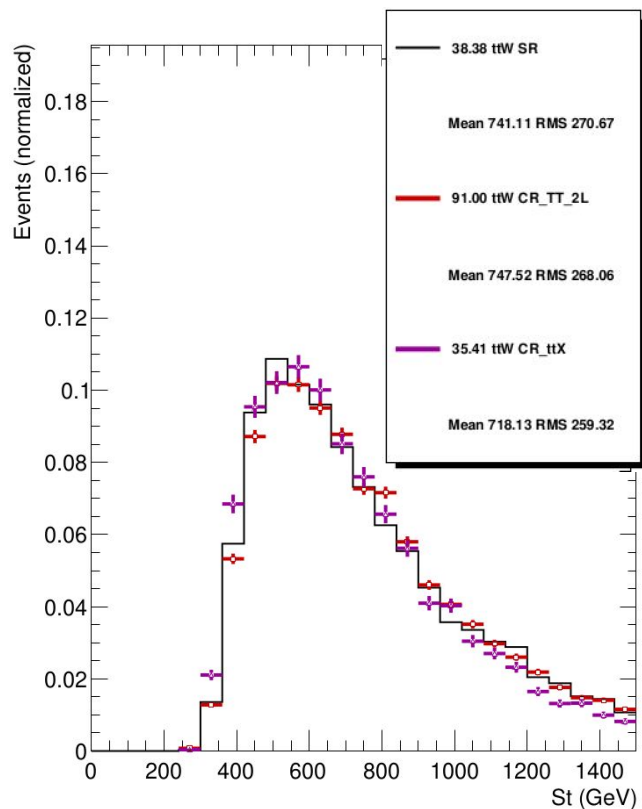

2 μ channel

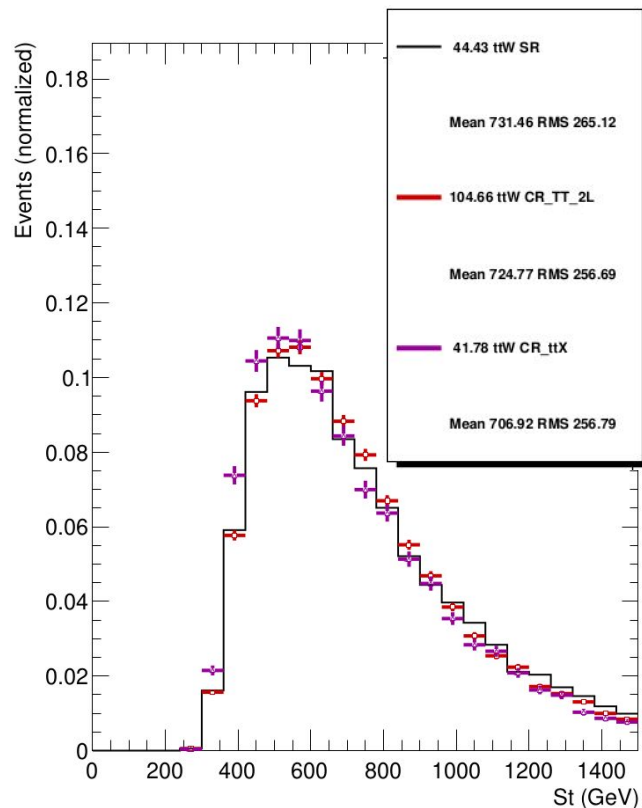

1 μ +1e channel

Control regions vs Signal region (ttW)

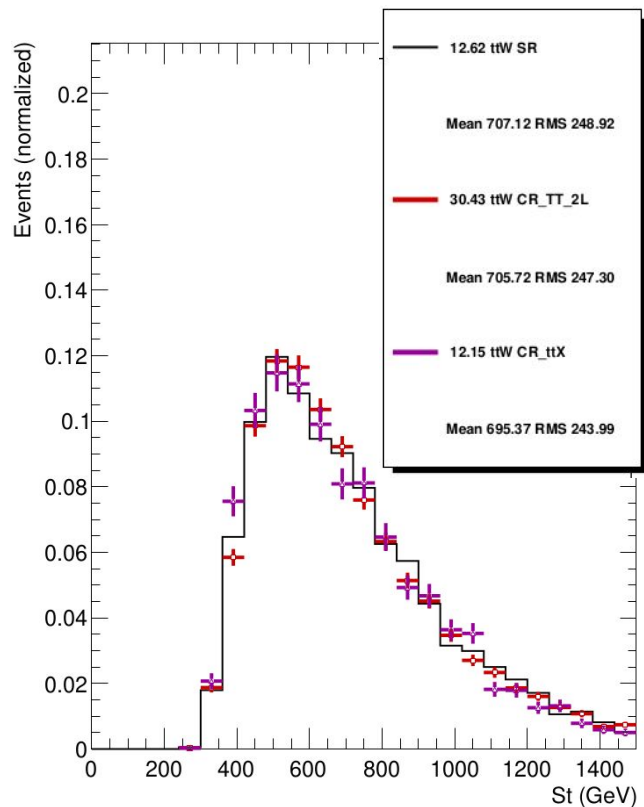

2e channel

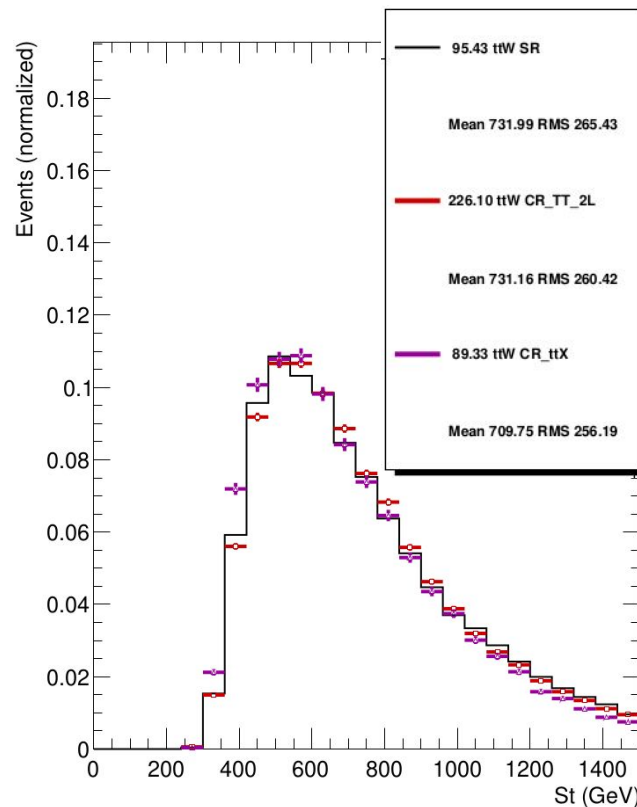

Total

Control regions vs Signal region (ttZ)

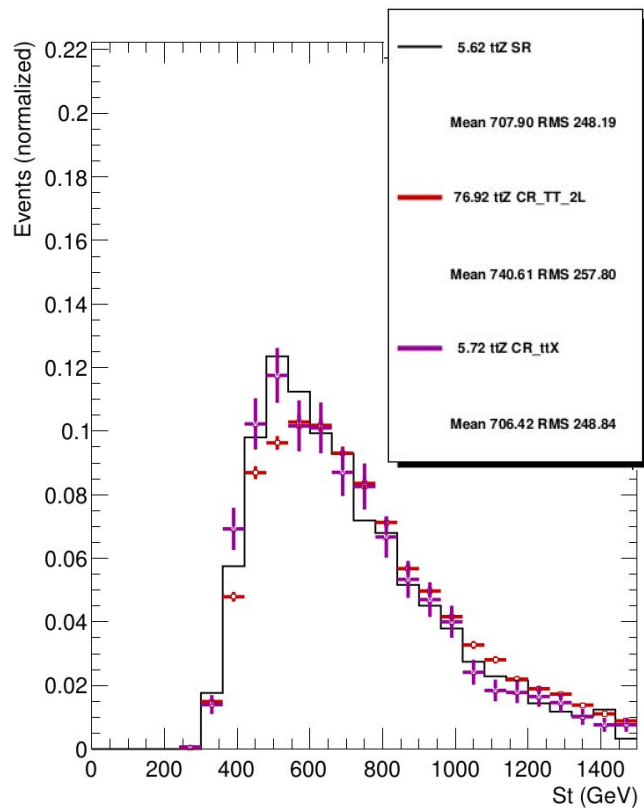

2 μ channel

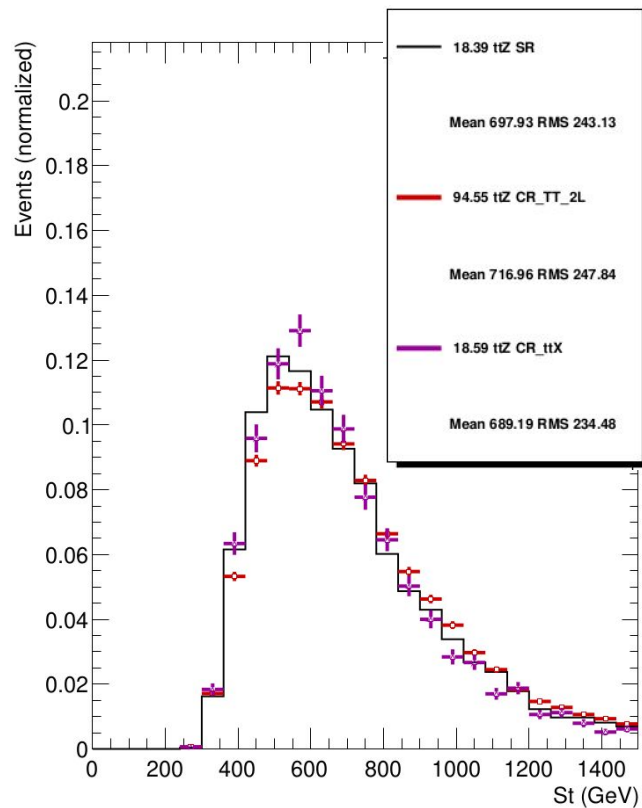

1 μ +1e channel

Control regions vs Signal region (ttZ)

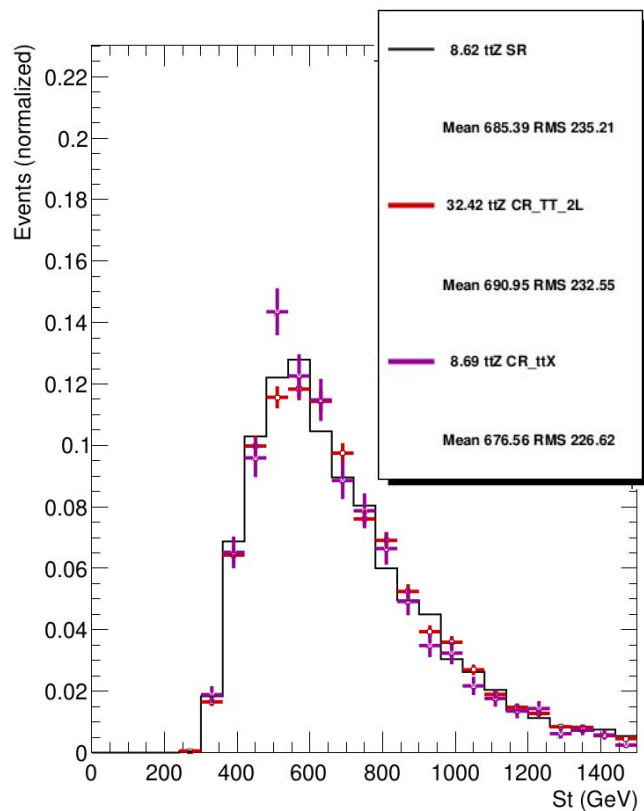

2e channel

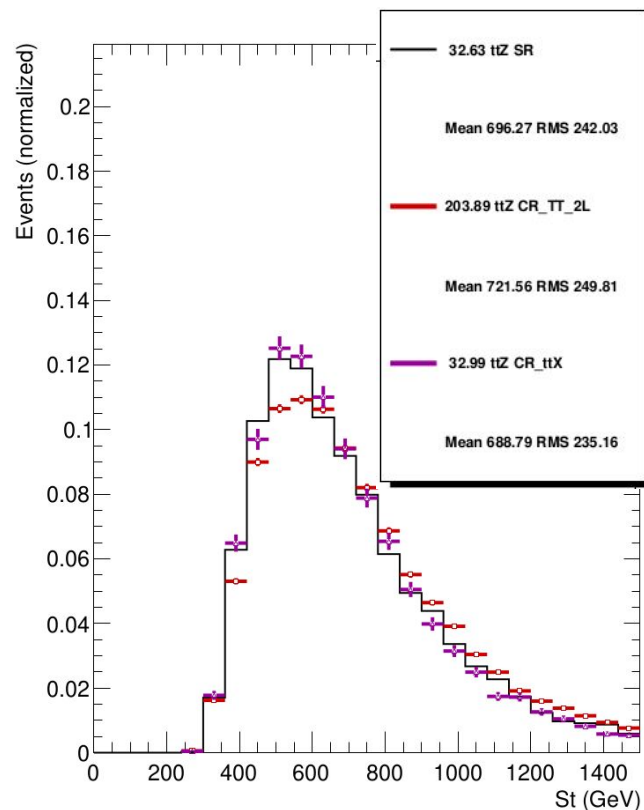

Total

Control regions vs Signal region (ttX)

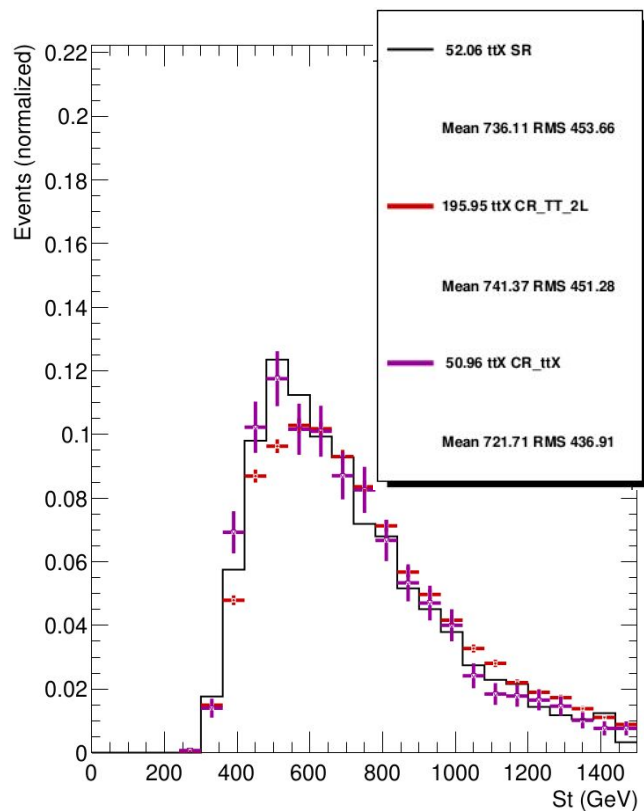

2 μ channel

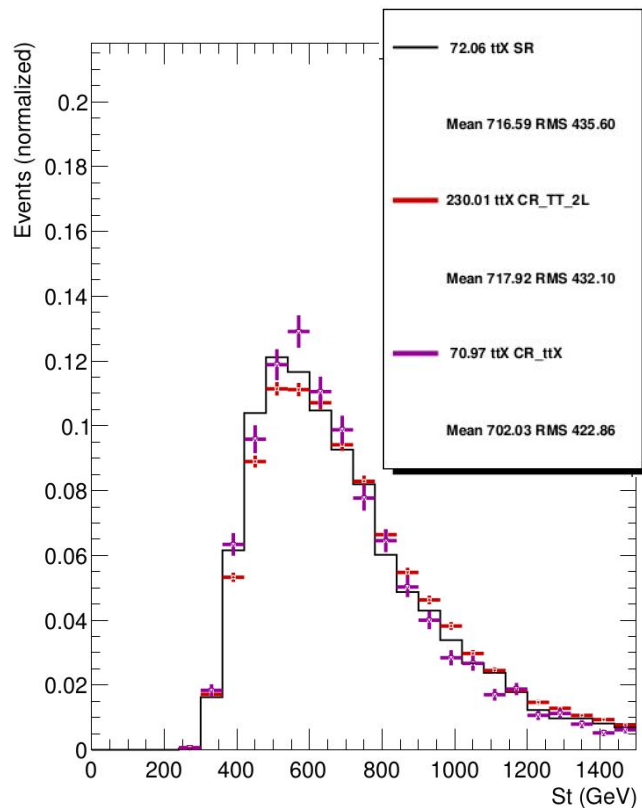

1 μ +1e channel

Control regions vs Signal region (ttX)

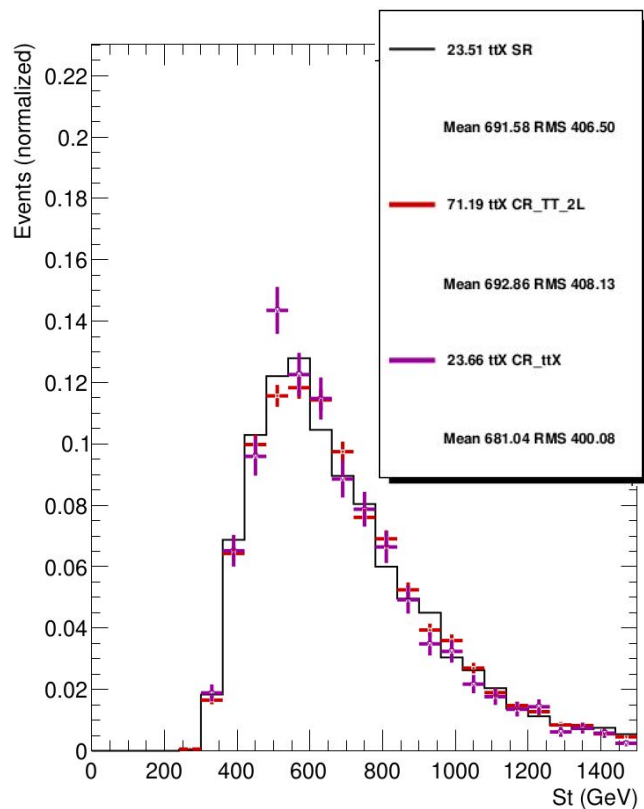

2e channel

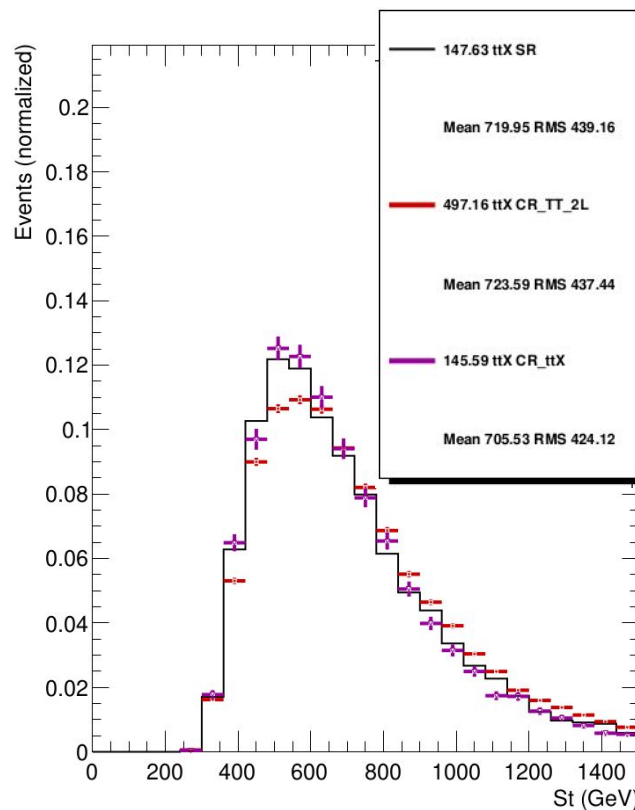

Total

Control regions vs Signal region (TT_SL)

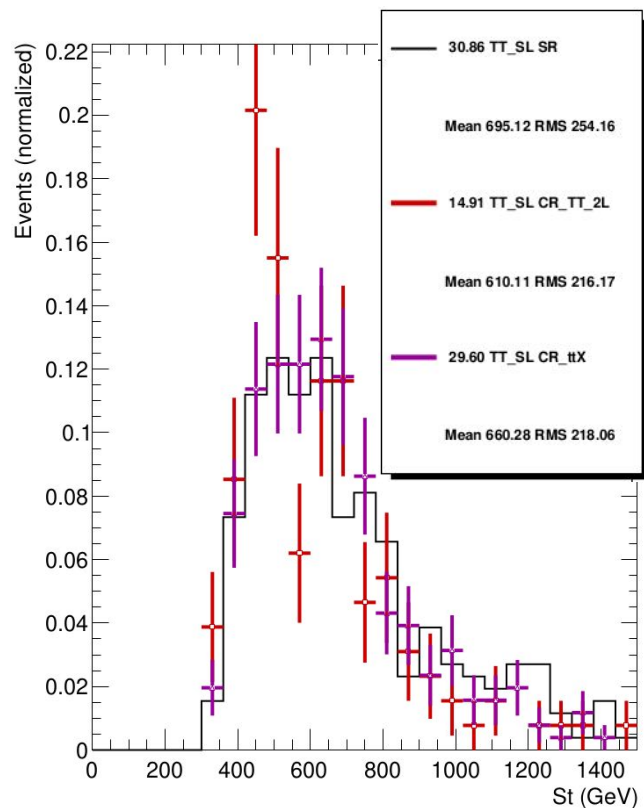

2 μ channel

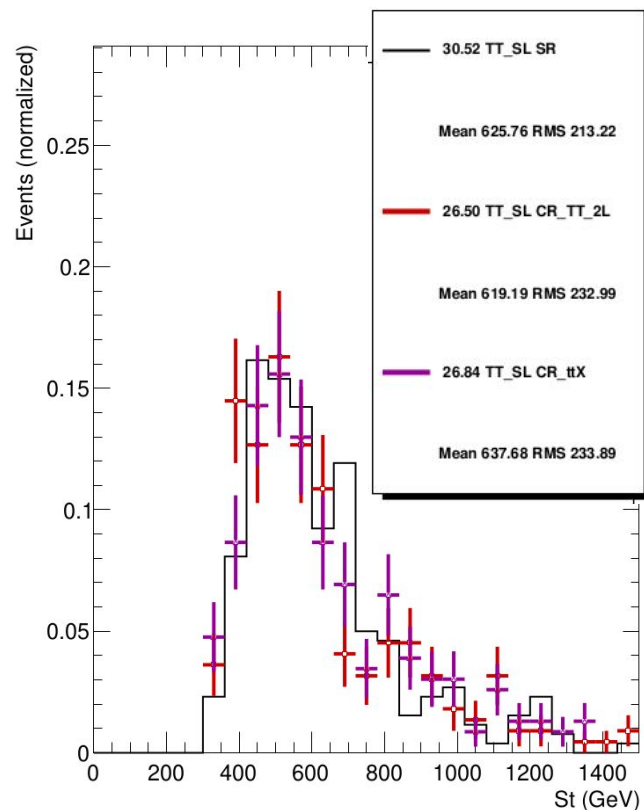

1 μ +1e channel

Control regions vs Signal region (TT_SL)

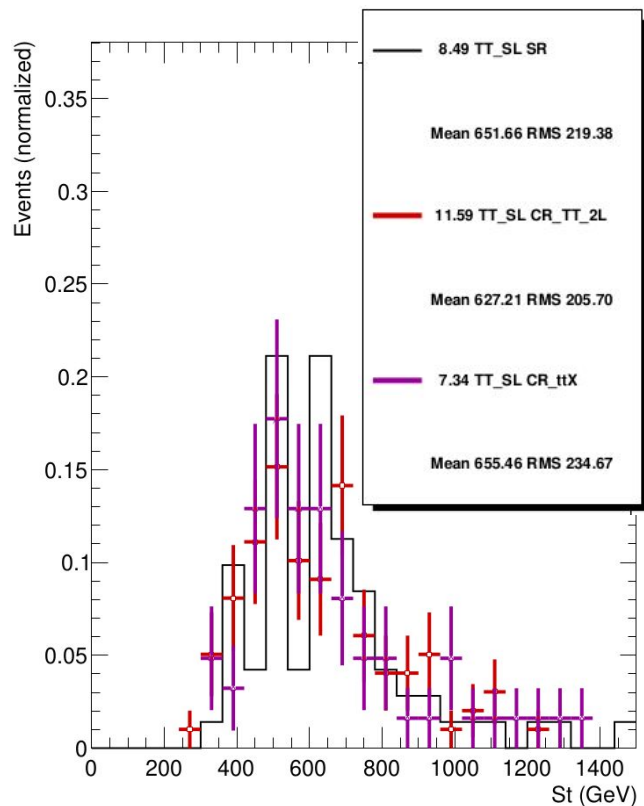

2e channel

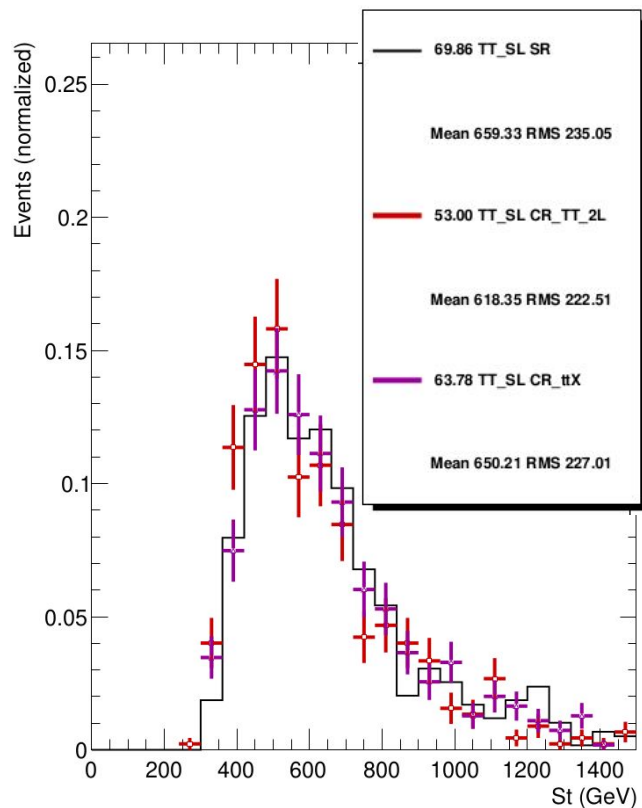

Total

Control regions vs Signal region (TT_2L)

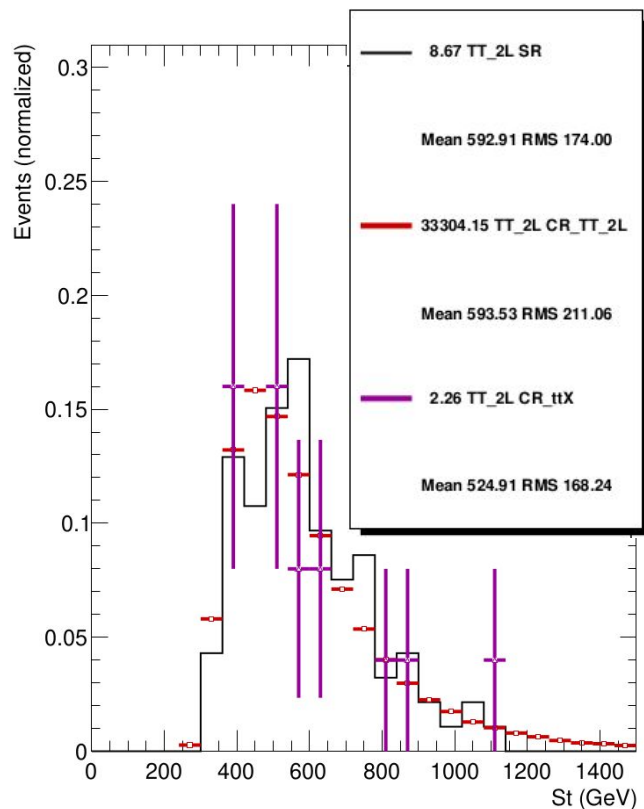

2 μ channel

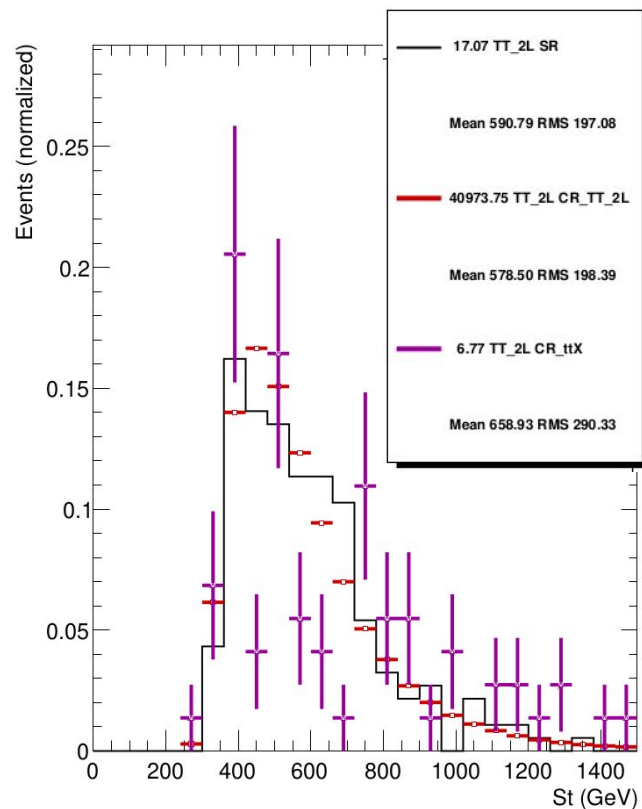

1 μ +1e channel

Control regions vs Signal region (TT_2L)

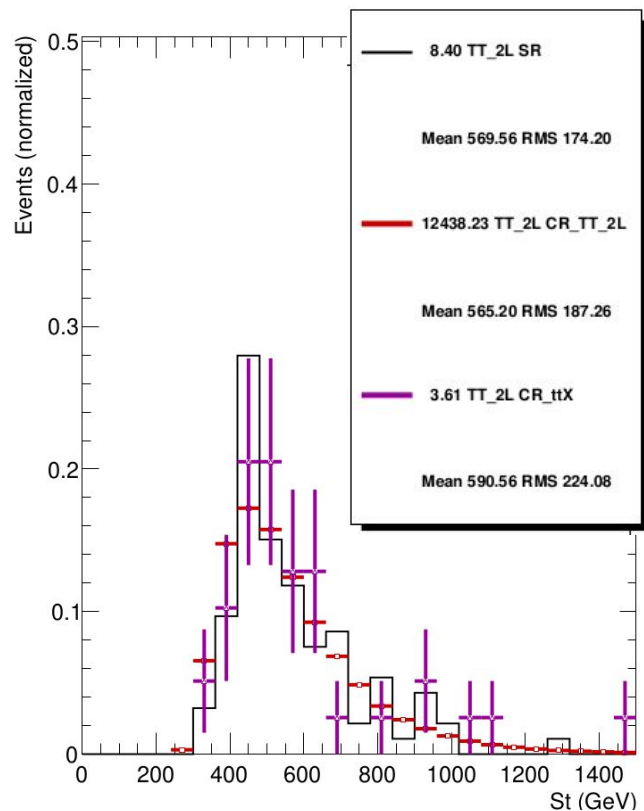

2e channel

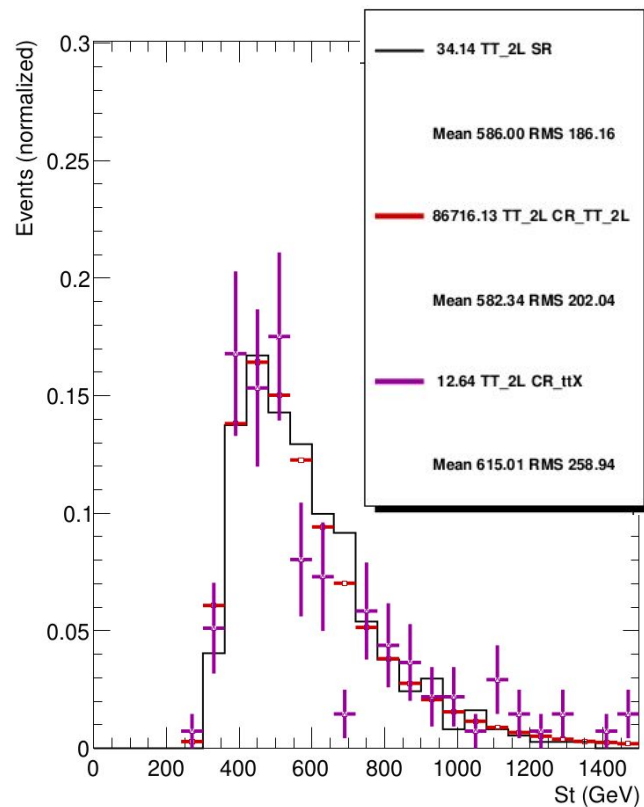

Total

Control regions - TT_2L vs Single top

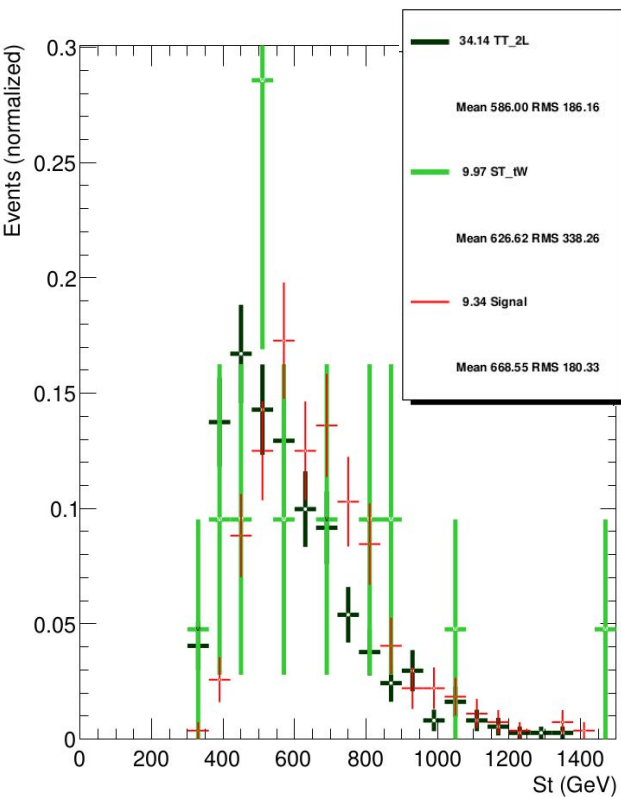

SR

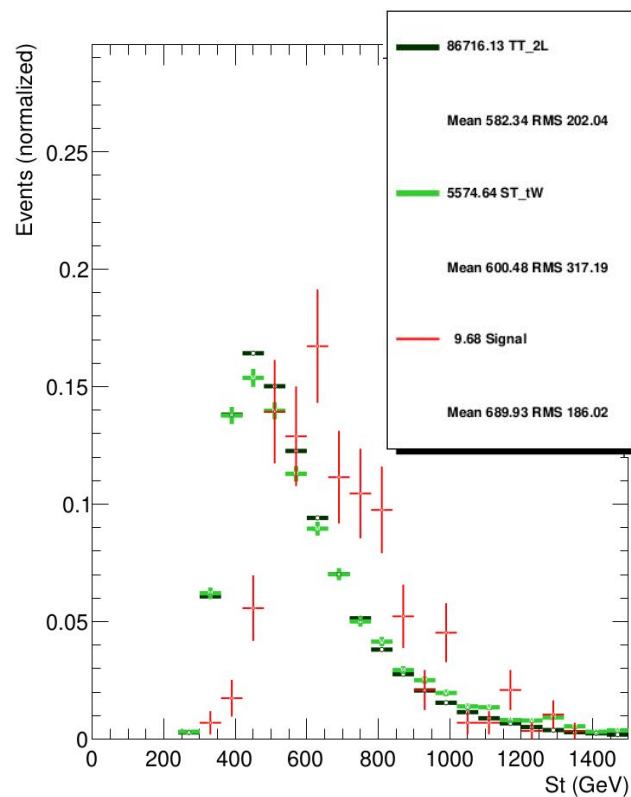

CR TT_2L

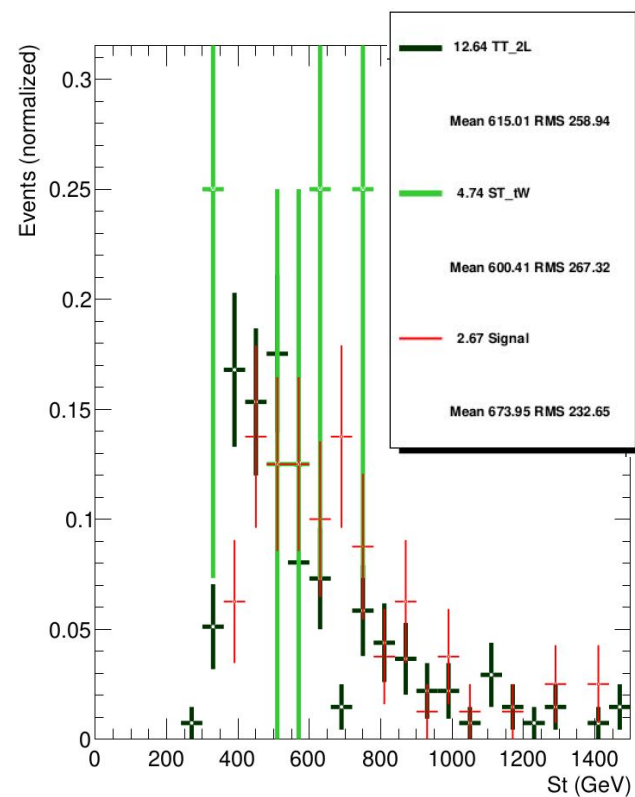

CR ttX