



**HAL**  
open science

## Recent highlights from INDRA and FAZIA

Diego D. Gruyer

► **To cite this version:**

Diego D. Gruyer. Recent highlights from INDRA and FAZIA. International Workshop on Multi facets of Eos and Clustering 2024, May 2024, Catane, Sicile, Italy. in2p3-04677535

**HAL Id: in2p3-04677535**

**<https://in2p3.hal.science/in2p3-04677535v1>**

Submitted on 26 Aug 2024

**HAL** is a multi-disciplinary open access archive for the deposit and dissemination of scientific research documents, whether they are published or not. The documents may come from teaching and research institutions in France or abroad, or from public or private research centers.

L'archive ouverte pluridisciplinaire **HAL**, est destinée au dépôt et à la diffusion de documents scientifiques de niveau recherche, publiés ou non, émanant des établissements d'enseignement et de recherche français ou étrangers, des laboratoires publics ou privés.

# Recent highlights from INDRA and FAZIA

(since 2021)

**Diego Gruyer, LPC Caen, France**  
(for the INDRA and FAZIA Collaborations)



The nuclear equation of state  
 Fundamental properties of nuclear matter.  
 Macroscopic counterpart of nuclear interaction.

$$P(\rho, T) \leftrightarrow e(\rho_n, \rho_p, T)$$

### Implication in astrophysics

Mandatory ingredient to compute neutron star mass-radius : solve the relativistic hydrostatic equation (TOV) starting from the core density down to the surface of the star.

→ Very sensitive to the equation of state !

### Observational constraints

Any valid equation of state should be able to produce a neutron star as heavy as the heaviest observed one. Precise measurement of both mass and radius would drastically constrain the EoS !

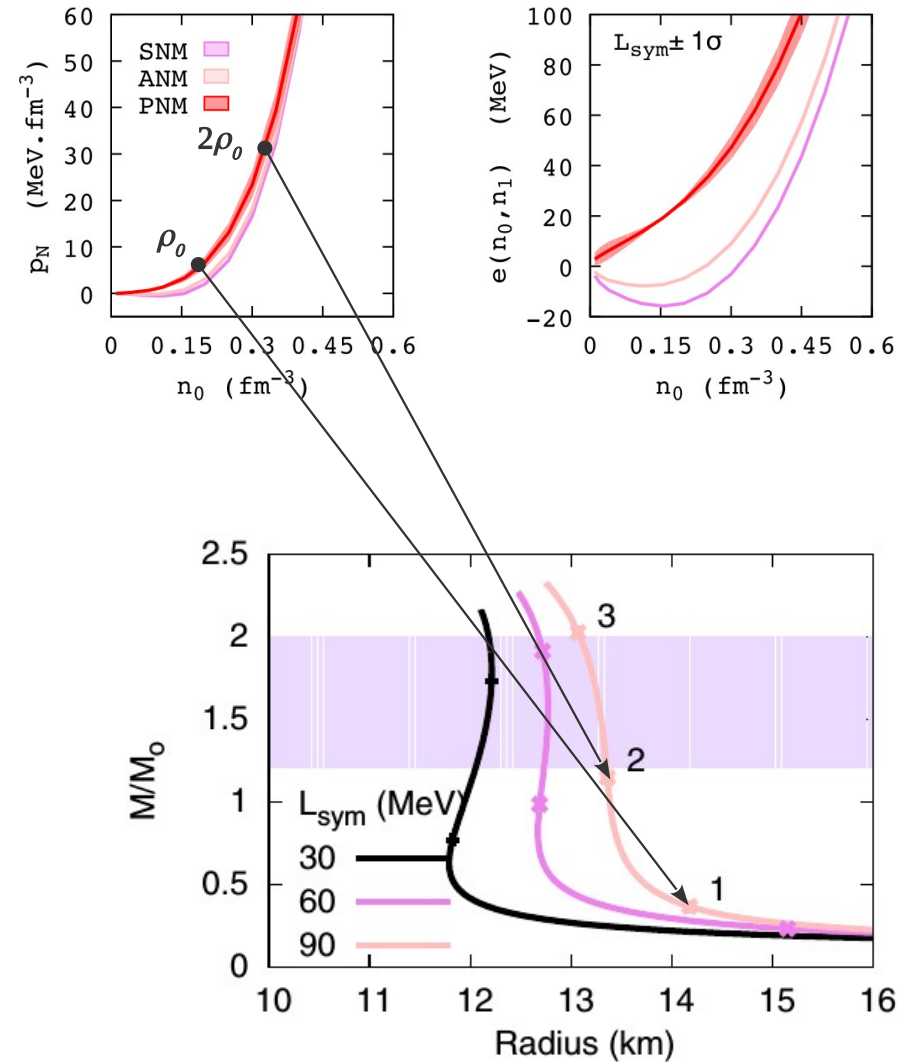

[1] Margueron, PRC 97 (2018) 025805, 97 (2018) 025806

# Heavy ion collisions

During peripheral collisions, projectile and target interact and exchange nucleons.

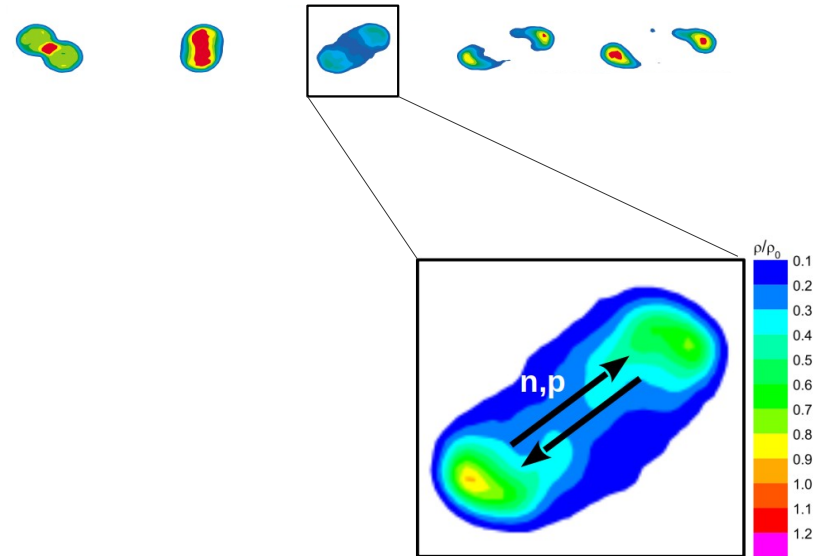
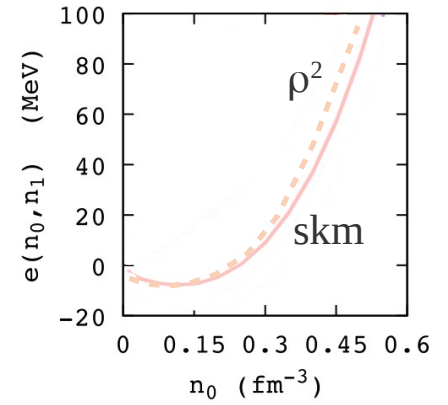
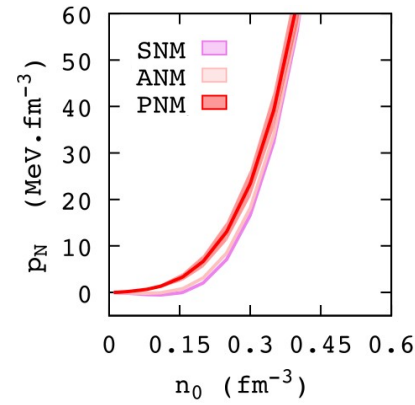

[1] Margueron PRC 97 (2018) 025805  
[2] Tsang PRL 92 (2004) 062701

## Heavy ion collisions

During peripheral collisions, projectile and target interact and exchange nucleons.

## Isospin equilibration

Projectile and target with different neutron to proton ratio equilibrate their N/Z over time. Two different interactions, leading to different equations of state, produce different equilibration path.

## Experimental constraints

Any experimental measurement of the isospin equilibration rate would constrain the EoS !

→ See talks of Q. Fable, C. Ciampi and S. Mallik

→ Critical role of clustering at low density

[1] Margueron PRC 97 (2018) 025805

[2] Tsang PRL 92 (2004) 062701

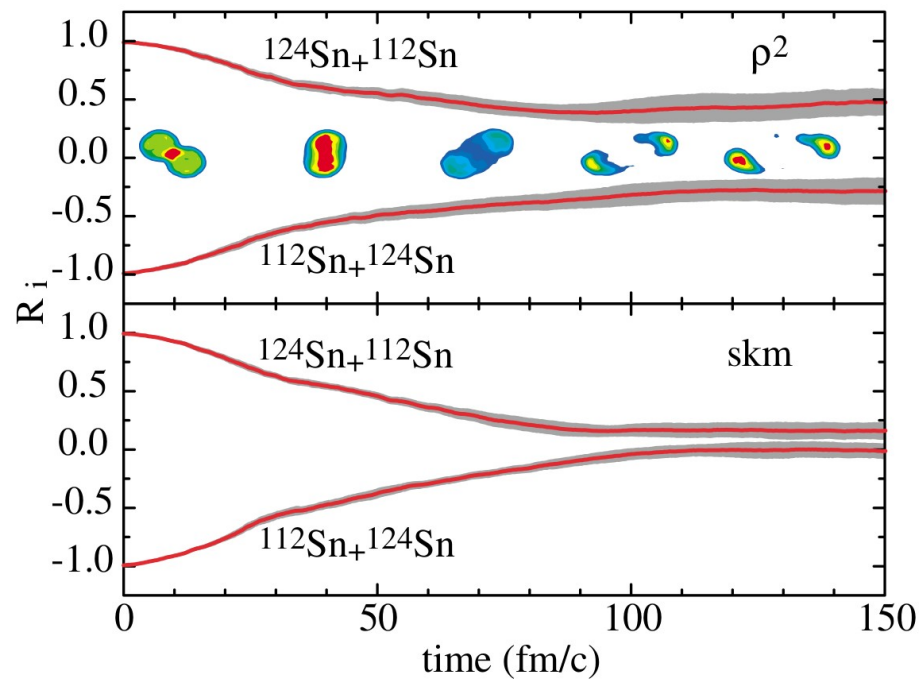
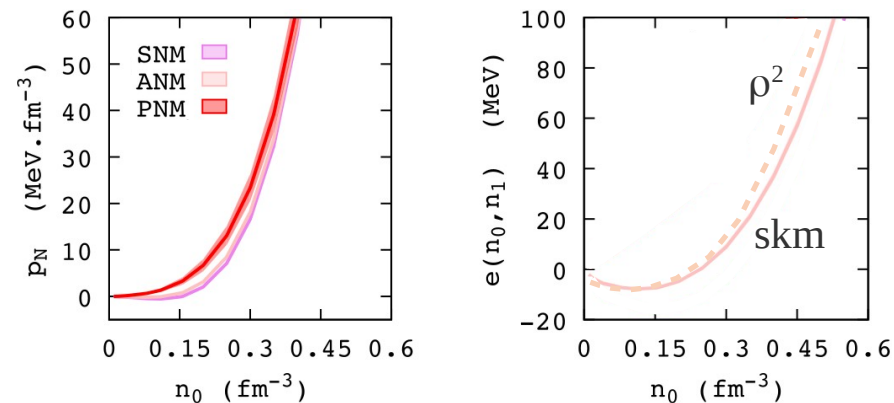

**INDRA classic  
GANIL**

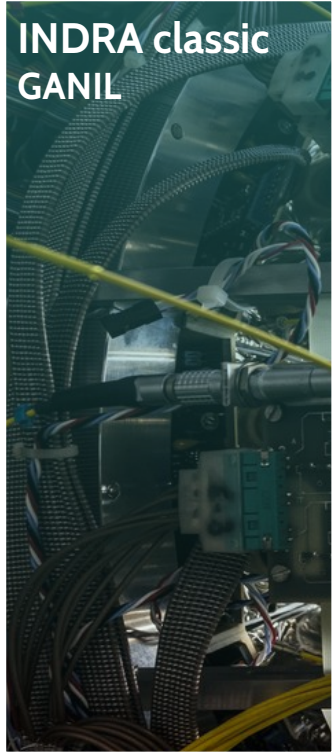

**INDRA classic  
GSI**

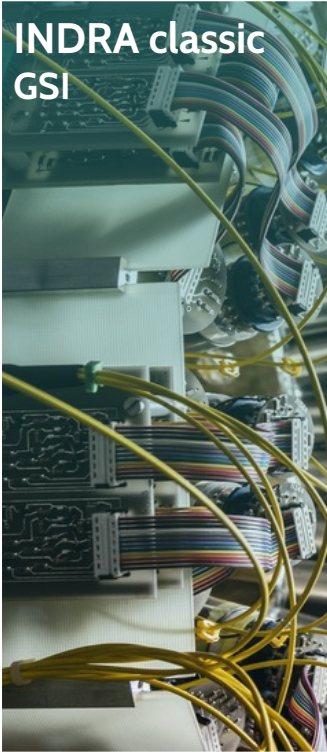

**INDRA-VAMOS  
GANIL**

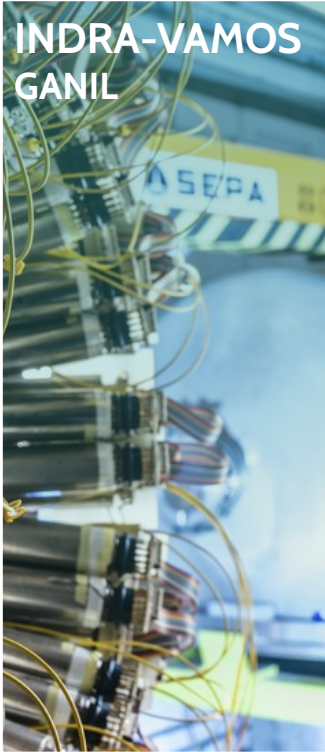

**FAZIA 4-6b  
LNS**



**INDRA-FAZIA  
GANIL**



**FAZIA 4b  
RAON**



## INDRA classic

4 $\pi$  charged particle multidetector optimized for detecting  $\sim 50$  particles. 17 rings with 12 to 24 telescopes : IC-Si-CsI ( $<45^\circ$ ), IC-CsI ( $>45^\circ$ ). Covers 90% of solid angle (336 modules). Full charge identification, masses resolved up to  $Z\sim 5$ .

## Experimental campaign at GANIL

Four experimental campaigns and few specific experiments at GANIL. Last INDRA classic experiment in 2011. Wide range of systems in terms of energy, total charge and charge asymmetry.  
→ All data still available for analysis.

## Machine learning, EoS and $\sigma_{NN}$

Characterization of the nuclear equation of state using Ni + Ni central collisions from INDRA and INDRA-FAZIA data. Neural network reconstruction.

→ Experimental constraints on  $\sigma_{NN}$

→ See A. Valente's talk

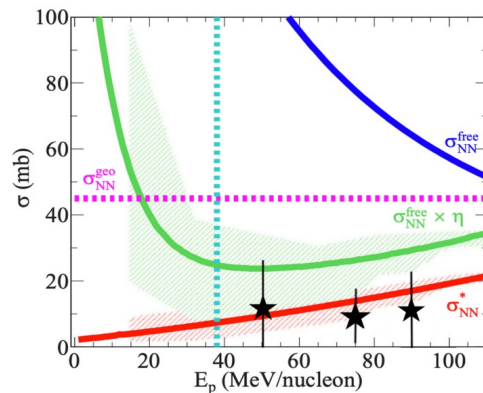
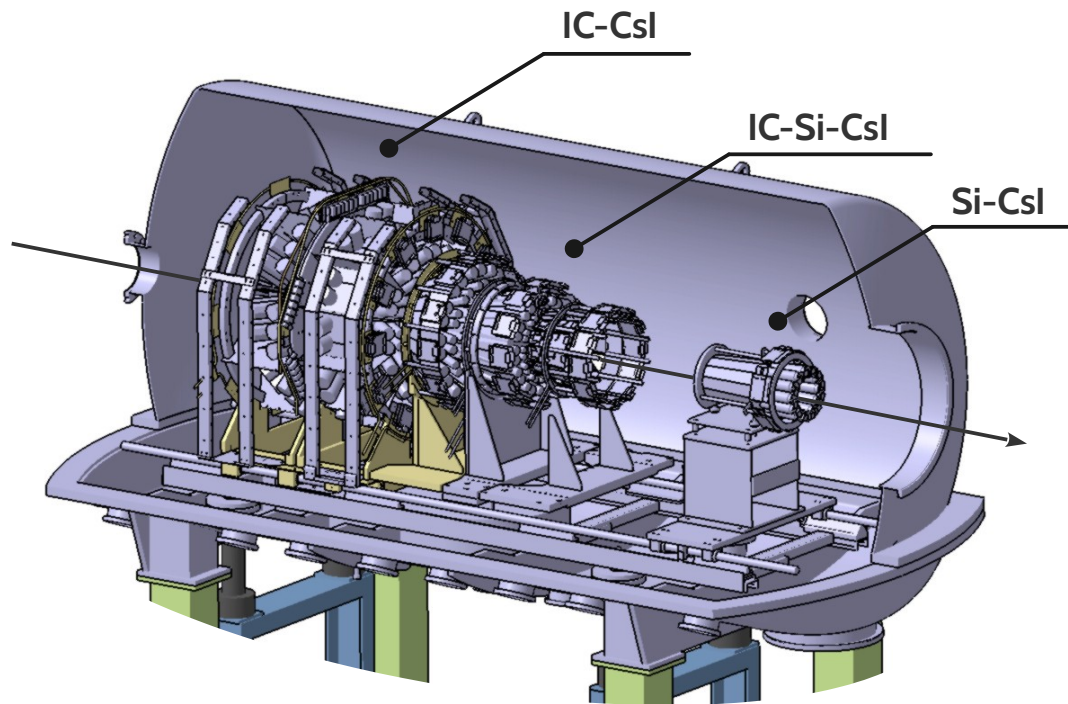

Henri, PRC 101 (2020) 064622

© A. Valente

## Low density in-medium effects

Experimental equilibrium constants of  $Z=1, 2$  produced in  $^{124,136}\text{Xe} + ^{124,112}\text{Sn}$  collisions at 32 MeV/nuc (mid-rapidity expanding source) compared to RMF calculations with in-medium effects. Problems with  $^6\text{He}$ .

→ H. Pais et al. PRL 125 (2020) 012701

## Revisited isoscaling

Isoscaling on  $Z=1, 2$  using the same combinations of  $^{124,136}\text{Xe} + ^{124,112}\text{Sn}$  collisions at 32 MeV/nuc.  $^6\text{He}$  don't scale in these data due to finite size effects. The isoscaling quality evolves with the difference of temperature between the two systems.

→ A. Rebillard-Soulié, J. Phys. G 51 (2024) 015104

## Mass fractions

Compare experimental and RMF mass fractions using INDRA and INDRA-FAZIA data (vaporization).

→ T. Costudio, article in preparation (PESSOA grant)

→ See A. Rebillard-Soulié's talk

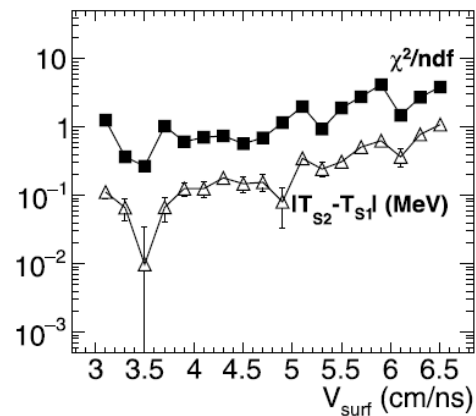
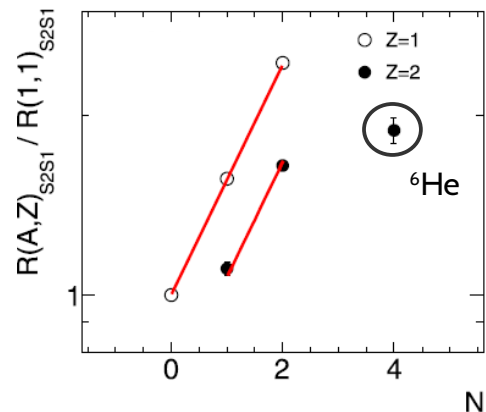
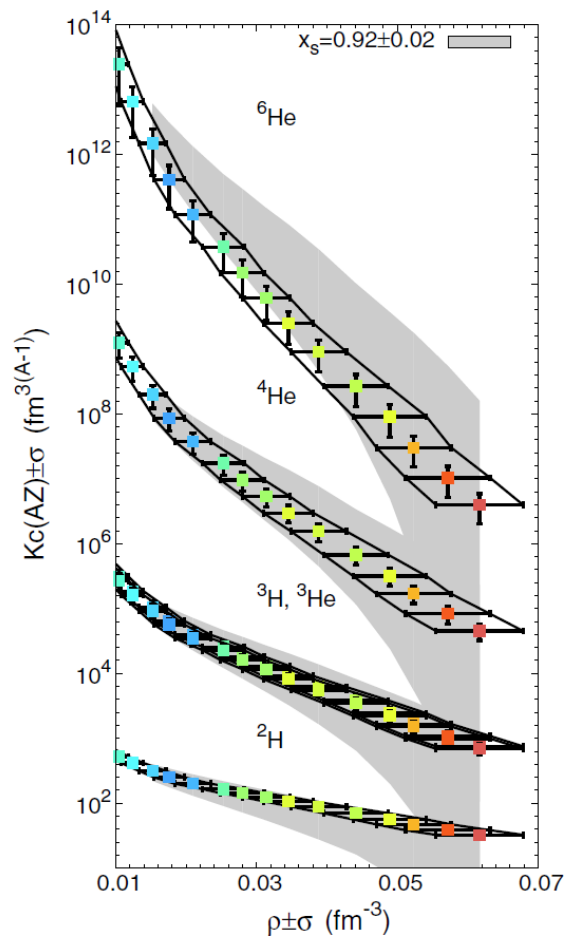



## INDRA classic GANIL

Publications  
A. Rebillard-Soulié,  
J. Phys. G 2024

PhD thesis  
A. Valente

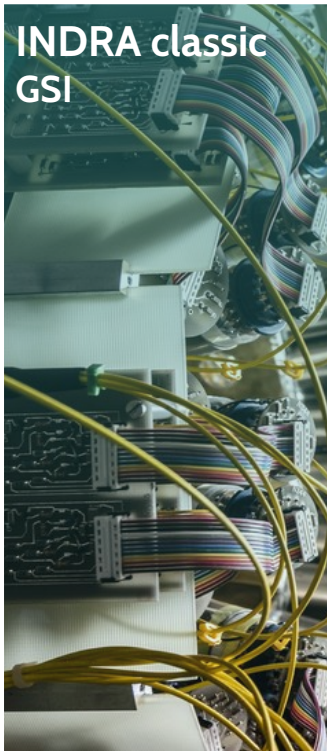

## INDRA classic at GSI

INDRA detector but at GSI so higher energy beams.  
→ Xe + Sn and Au + Au up to 150 MeV/nuc.

## Clustering and density

Experimental maximum density increases with increasing incident energy in agreement with transport calculations.

→ T. Genard's PhD thesis, see A. Chbihi's talk

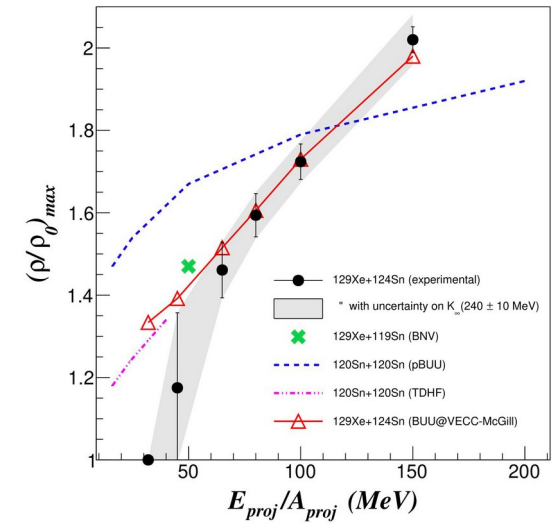

© T. Genard

## Direct and elliptic flow

Light cluster direct flow decreases with increasing the system N/Z in Ni+Ni collisions at 52 MeV/nuc. (INDRA-FAZIA) but increases for Xe+Sn at 100 MeV/nuc. (INDRA@GSI). Very little isospin dependence of elliptic flow.

→ See S.H. Nam's talk

→ link with RAON/FRIB high energies

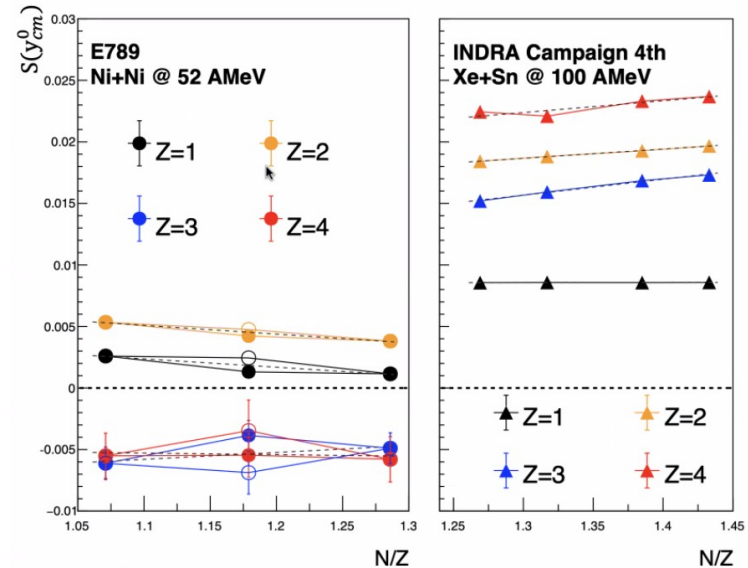

© S.H. Nam

## INDRA classic GANIL

### Publications

A. Rebillard-Soulié,  
J. Phys. G 2024

### PhD thesis

A. Valente

## INDRA classic GSI

### PhD thesis

T. Génard (2023)  
S. H. Nam

## INDRA-VAMOS GANIL

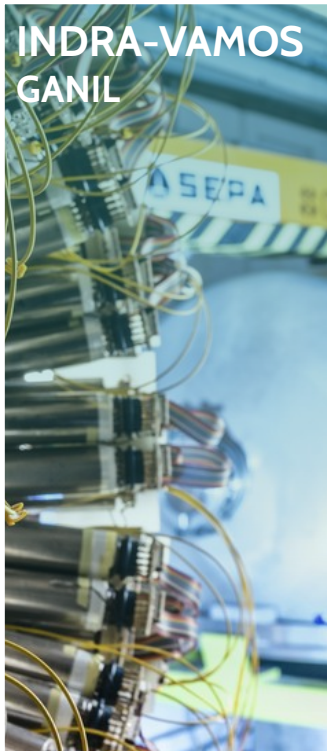

## FAZIA 4-6b LNS



## INDRA-FAZIA GANIL



## FAZIA 4b RAON



## INDRA-VAMOS coupling

INDRA ring 6-17 coupled to the VAMOS spectrometer in GANIL. Good angular coverage with charge and mass identification in VAMOS.

→  $^{40,48}\text{Ca} + ^{40,48}\text{Ca}$  at 35 MeV/nuc.

## Isoscaling

Isoscaling of reconstructed quasi-projectiles (QP). Clear evolution of the isoscaling parameters with the QP size evidencing strong surface effects.

→ Fable, PRC **106** (2022) 024605

## Isospin transport

Isospin transport ratio as a function of centrality. Evolution toward isospin equilibration for the most central collisions. Full equilibration not reached. Evidence of neutron enrichment at mid-rapidity.

→ Fable, PRC **107** (2023) 014604

→ See Q. Fable's talk

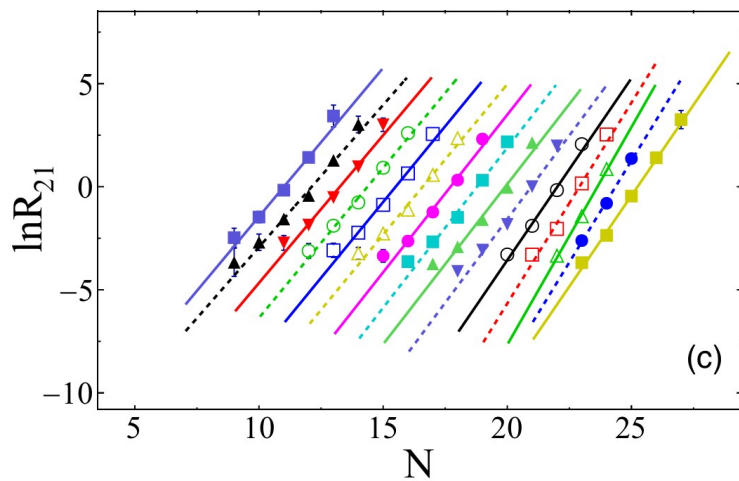
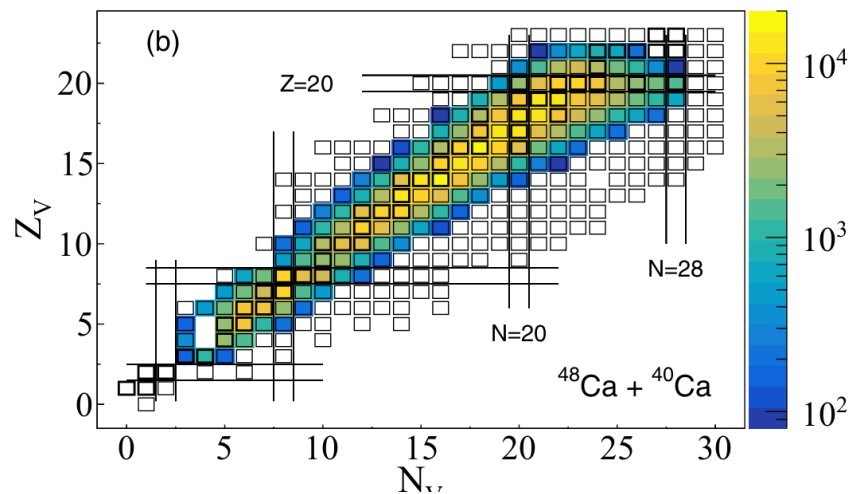

## INDRA classic GANIL

### Publications

A. Rebillard-Soulié,  
J. Phys. G 2024

### PhD thesis

A. Valente

## INDRA classic GSI

### PhD thesis

T. Génard (2023)  
S. H. Nam

## INDRA-VAMOS GANIL

### Publications

Q. Fable, PRC 2022  
Q. Fable, PRC 2023  
Q. Fable, PRC 2024

## FAZIA 4-6b LNS



## INDRA-FAZIA GANIL



## FAZIA 4b RAON



## FAZIA collaboration

European initiative to build a charged particle multidetector with isotopic resolution (Z and A) : optimization detectors and digital electronics.  
→ Korean colleagues joined the collab. in 2018

## The FAZIA detector

Blocks of 4x4 Si-Si-CsI telescopes with modular geometry. Identification with  $\Delta E-E$  and PSA : full charge identification, masses resolved up to  $Z \sim 25$ .

## FAZIA at LNS

Campaign at LNS Catania (2014-2018 ) with 4 to 6 blocks: isospin diffusion and drift [1], first imbalance ratio with FAZIA [2], cluster production and decay [3], QP break-up channel [4], pre-equilibrium [5].  
→ Review article in preparation by A. Camaiani

[1] Piantelli, *EPJA* **103** (2021) 014603

[2] Camaiani, *PRC* **102** (2020) 044607, *EPJA* **103** (2021) 014605

[3] Frosin, *PRC* **107** (2023) 044614

[4] Piantelli, *PRC* **101** (2020) 034613, *PRC* **107** (2023) 044607

[5] Upadhyaya, submitted to *EPJA*

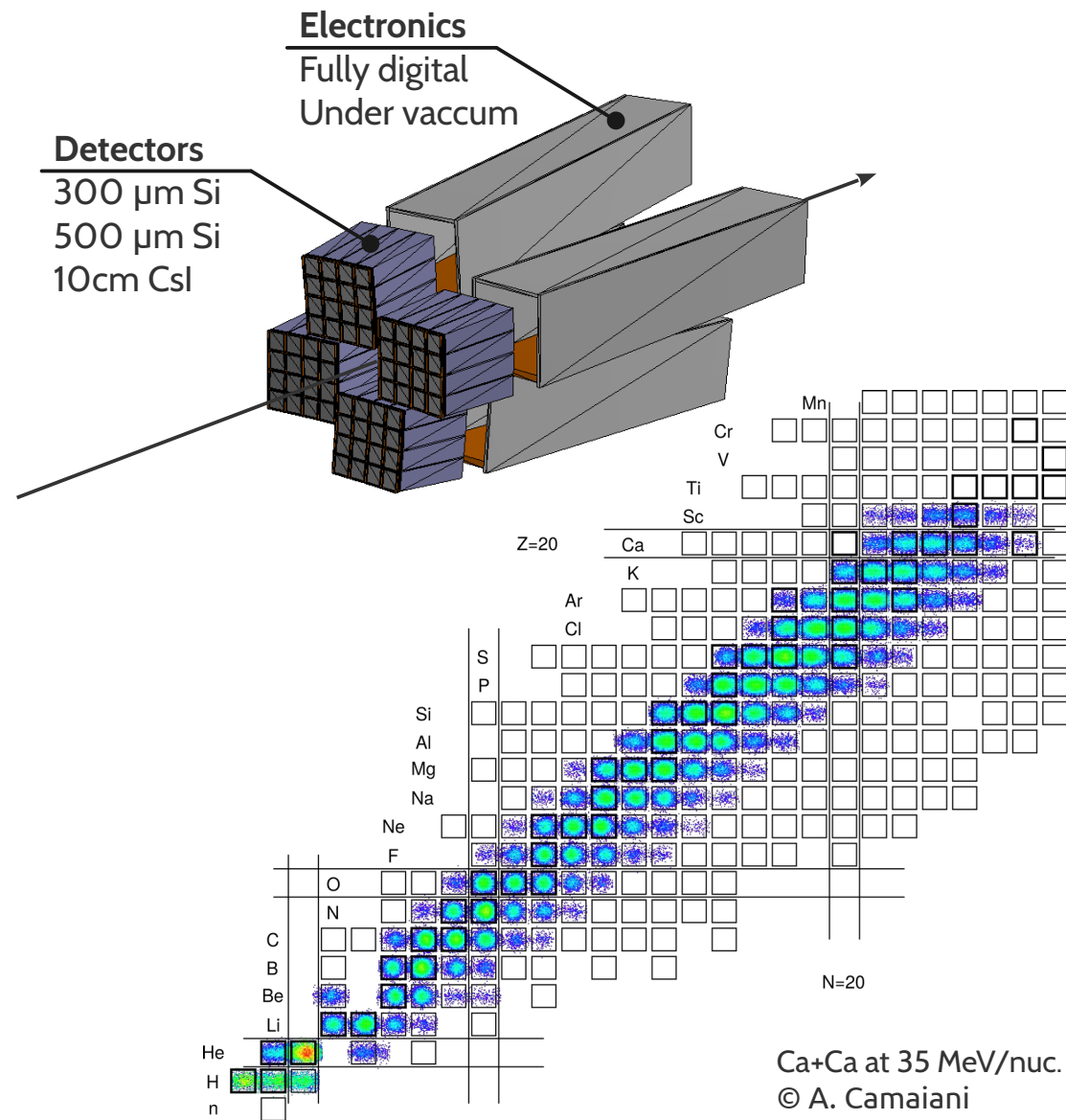

## Clustering in light systems

Experimental cluster production in light system collisions. Comparison with transport model calculations shows the role of dynamic cluster production.

→ Ne, S + C at 25 and 50 MeV/nuc. (FAZIACOR, LNS)

→ Frosin, PRC **107** (2023) 044614 (featured in Physics)

## Clustering and $\sigma_{NN}$

Bayesian analysis on Ne + C at 50 MeV/nuc. data compared to AMD calculations to infer the in-medium cross-section and clustering strength.

→ See S. Piantelli's talk

## Perspectives

Two experiments related to clustering in 2023 and repropose at the next GANIL PAC

→ Nucleon-nucleon clusterization and in-medium cross section from complete events, A. Camaiani

→ Study of clustering using low-energy reactions induced by neutron-rich oxygen isotopes, A. Chbihi

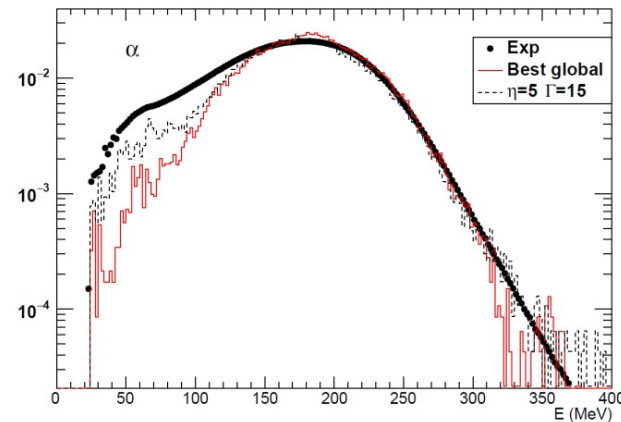
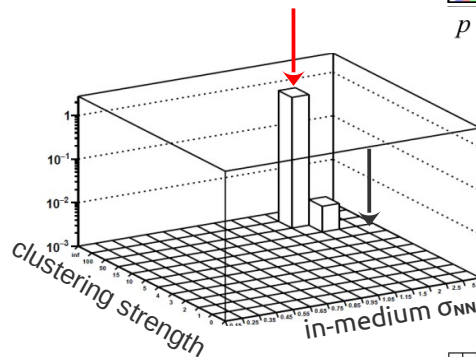
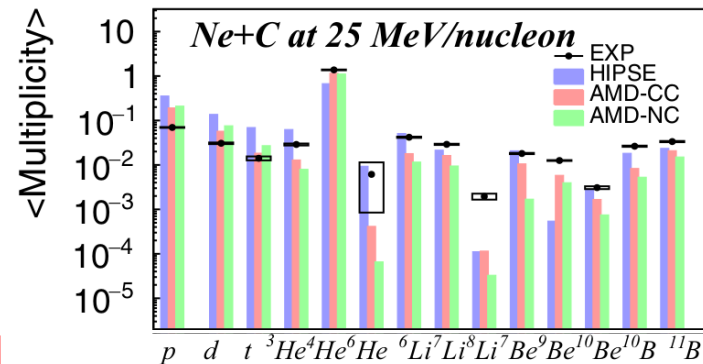

© S. Piantelli

## INDRA classic GANIL

### Publications

A. Rebillard-Soulié,  
J. Phys. G 2024

### PhD thesis

A. Valente

## INDRA classic GSI

### PhD thesis

T. Génard (2023)  
S. H. Nam

## INDRA-VAMOS GANIL

### Publications

Q. Fable, PRC 2022  
Q. Fable, PRC 2023  
Q. Fable, PRC 2024

## FAZIA 4-6b LNS

### Publications

S. Piantelli, PRC 2023  
C. Frosin, PRC 2023  
S. Upadhyaya, EPJA 2024

### PhD thesis

S. Upadhyaya (2022)

## INDRA-FAZIA GANIL



## FAZIA 4b RAON





## INDRA-FAZIA @ GANIL

INDRA rings 1 to 5 replaced by 12 FAZIA blocks (192 telescopes) in a wall configuration in 2018. First experiment in 2019 using INDRA classic without ionisation chambers.

→ INDRA and FAZIA upgrade in 2021/2022

→ Isotopic identification of forward emitted fragments

→ Event topology thanks to 80 % angular coverage

## Experiments

- |      |   |
|------|---|
| 2019 | Isospin transport and EoS                             |
| 2022 | Vaporisation and in medium clusters                   |
| 2025 | Size asymmetry and isospin transport                  |
| 2025 | Measurement of the $^{12}\text{C}$ Hoyle state radius |

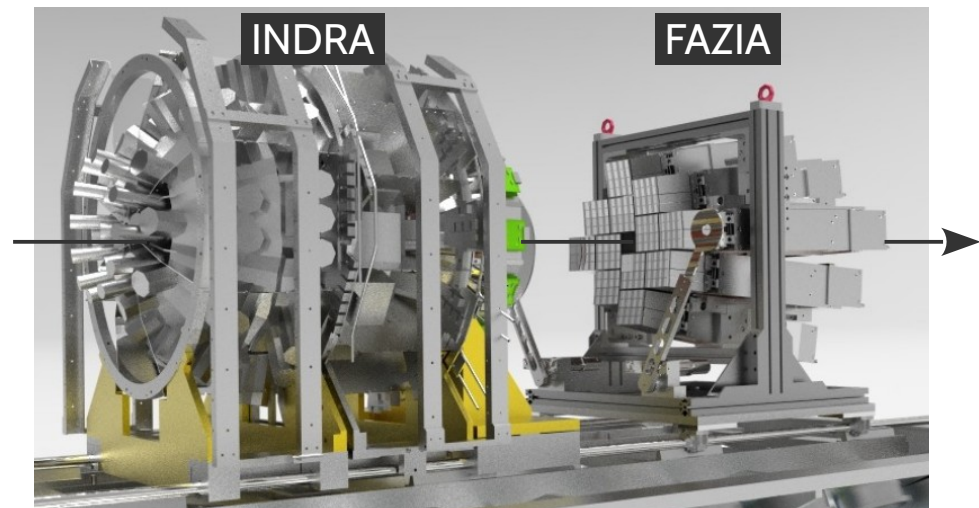

## Isospin transport experiment

Measure the isospin equilibrium « à-la-Tsang » but replacing the contact time by the impact parameter.

→  $^{58,64}\text{Ni} + ^{58,64}\text{Ni}$  at 32 and 52 MeV/nuc.

→ FAZIA to measure the isospin content

→ INDRA to estimate the collision centrality

## First results

First isospin transport ratios with rough estimate of the impact parameter. Effect of the quasi-projectile decay channel on the isospin transport ratio.

→ Ciampi, PRC 106 (2022) 024603

→ Ciampi, PRC 108 (2023) 054611

## Constraints on the EoS

Transport ratio versus better estimate of  $b$  and comparison with BUU to constrain the EoS !

→ see talks by C. Ciampi and S. Mallik

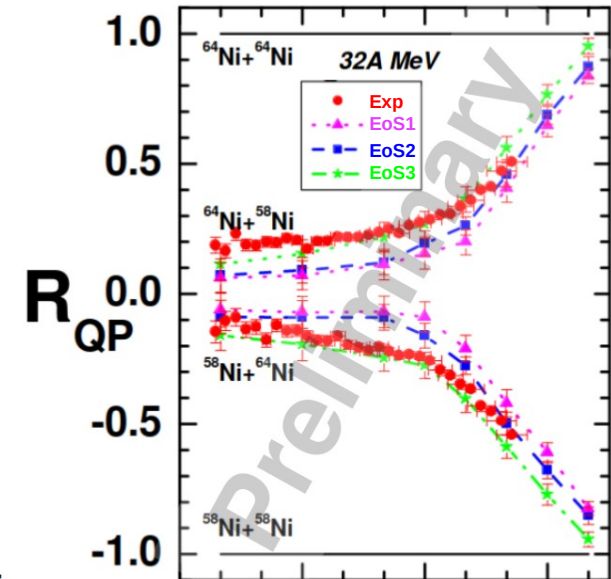
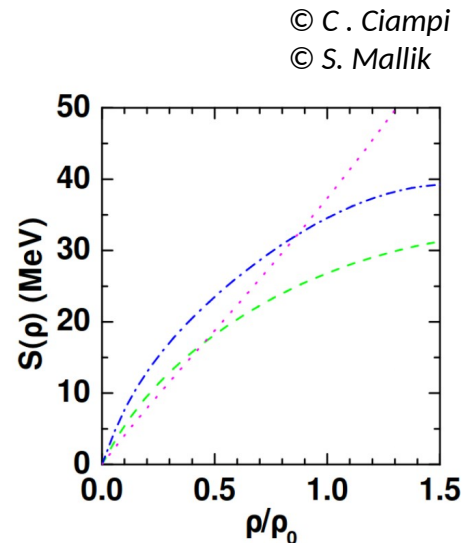
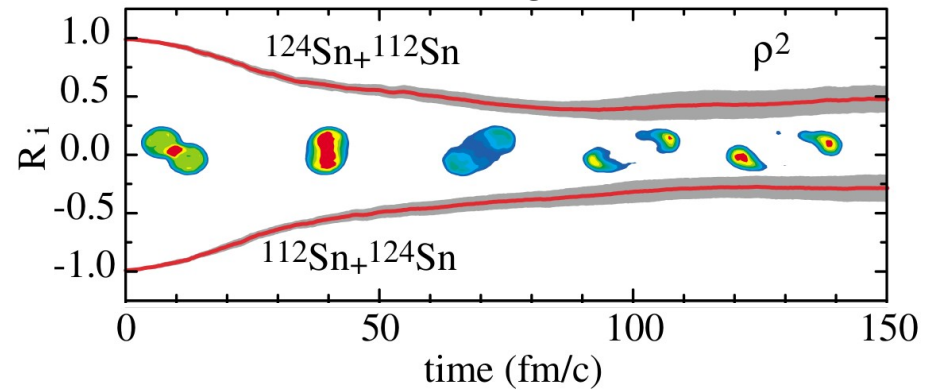

## INDRA resurrected

Complete renewal of the INDRA electronics, and upgrade of most INDRA silicon detectors.

- Better mass identification performances
- Improved dead time for better acquisition coupling with FAZIA

## FAZIA upgraded

Thicker silicon detectors from Korea (750 microns) for the central blocks. Accurate silicon calibrations with dedicated beams. Unprecedented isotopic identification (up to  $Z=27$ ) even in Si-CsI and at high energy.

- Encouraging for high energies at RAON or FRIB !

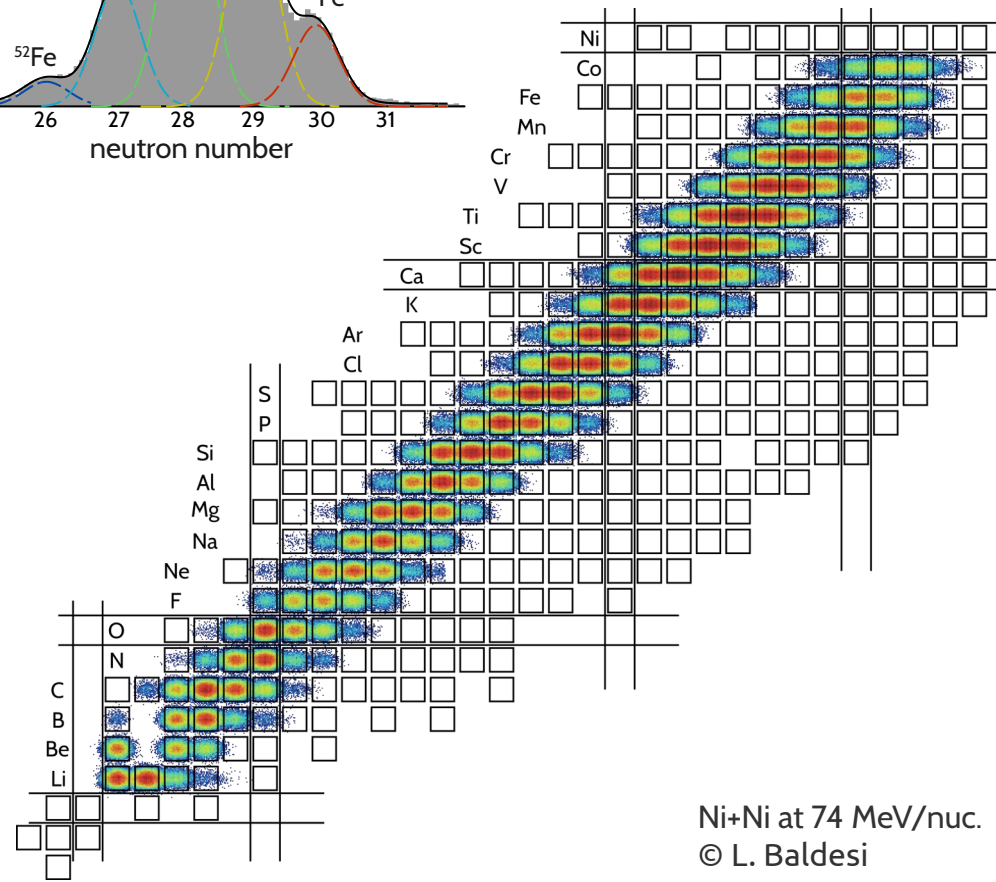
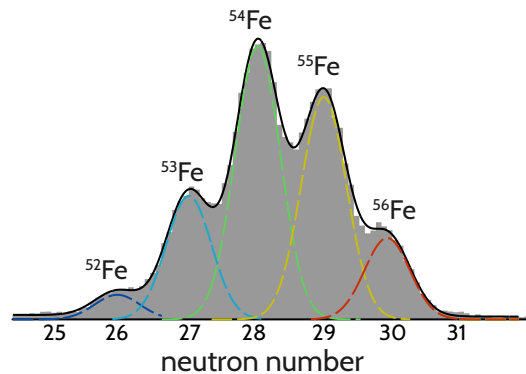

Ni+Ni at 74 MeV/nuc.  
© L. Baldesi

## Vaporization experiment

E818 experiment performed in 2022 (GANIL) to measure quasi-projectile (QP) vaporization using upgraded INDRA-FAZIA coupling.

→ Ar + Ni and Ni + Ni at 74 MeV/nuc.

→ Data reduction completed (Alex and Lucia) !

## Mass fractions and side feeding

Selection of a quasi-projectile vaporization source in Ar + Ni data. Mass fractions as a function of the QP excitation energy. Estimation of the side feeding contribution using correlation functions.

→ See A. Rebillard-Soulié's talk and L. Baldesi's poster

## In-medium effects

Compare mass fraction with RMF calculations including in-medium effects on light clusters (collaboration with Coimbra university/PESSOA grant).

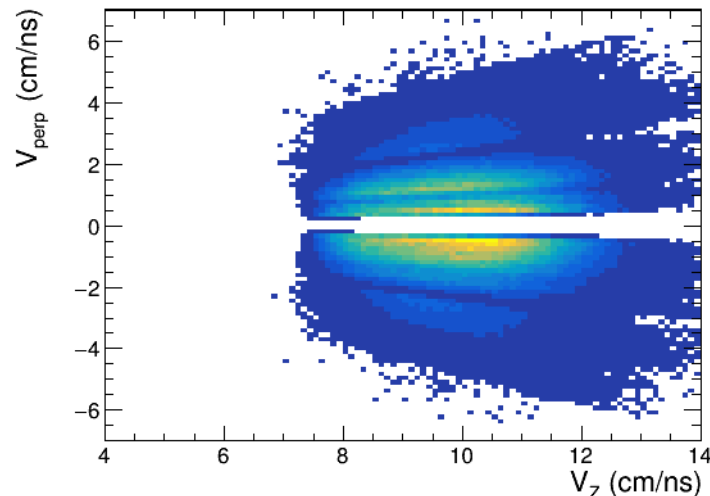

← alphas from QP vaporisation

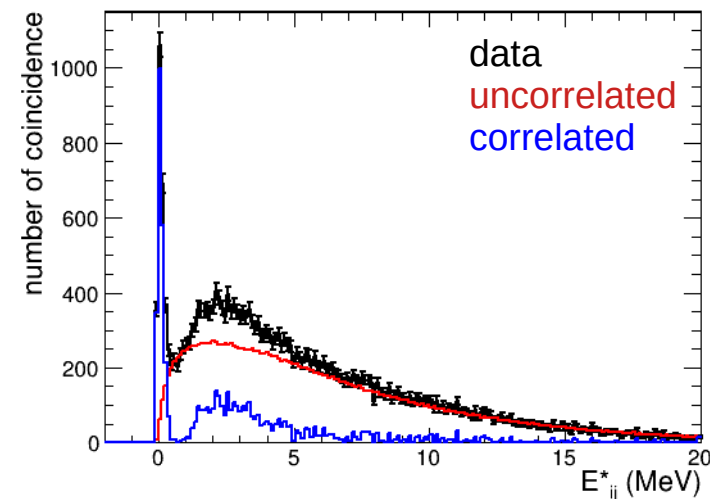

← alpha-alpha correlation

## Setup upgrade

Renewed INDRA ionization chambers (IC) and new beam intensity monitoring upgrade in 2024.

→ Beam test in July

## e884 experiment

→ Ciampi and Frankland, GANIL, 2025

Impact of projectile-target size asymmetry on the isospin equilibration rate extracted from quasi-projectile breakup reactions

→  $^{70}\text{Zn} + ^{28}\text{Si}$ ,  $^{70}\text{Zn}$ ,  $^{208}\text{Pb}$ , INDRA-FAZIA with IC

## e881 experiment

→ Gruyer and Dell'Aquila, GANIL, 2025

Measurement of the  $^{12}\text{C}$  Hoyle state radius using double-excitation inelastic scattering

→  $^{12}\text{C} + ^{12}\text{C}$  at 105 MeV, mostly FAZIA

→ PhD. of I. Dekhissi starting in 2024

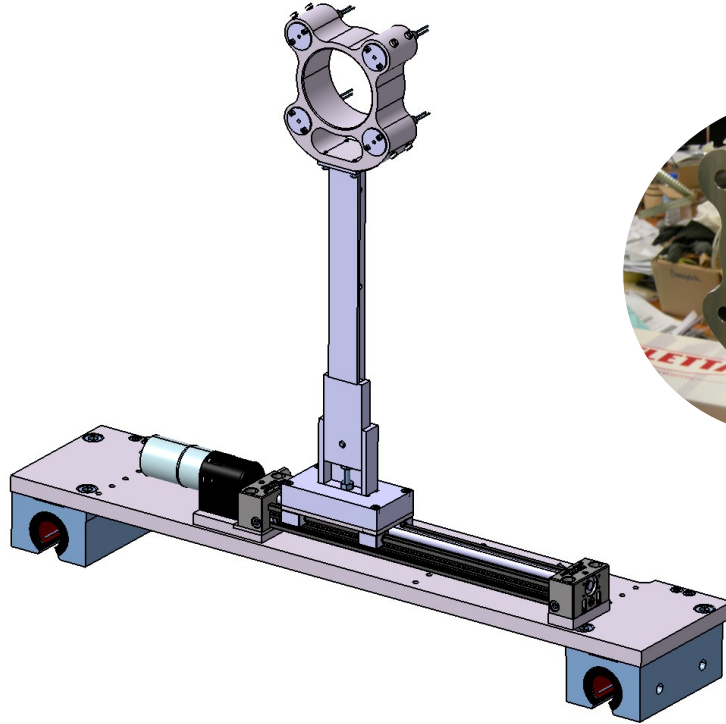
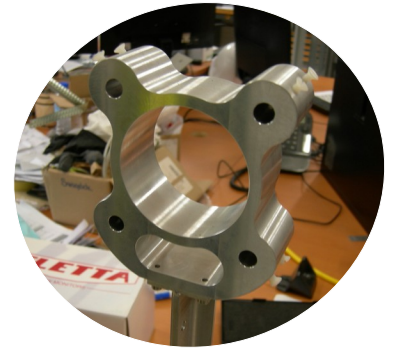
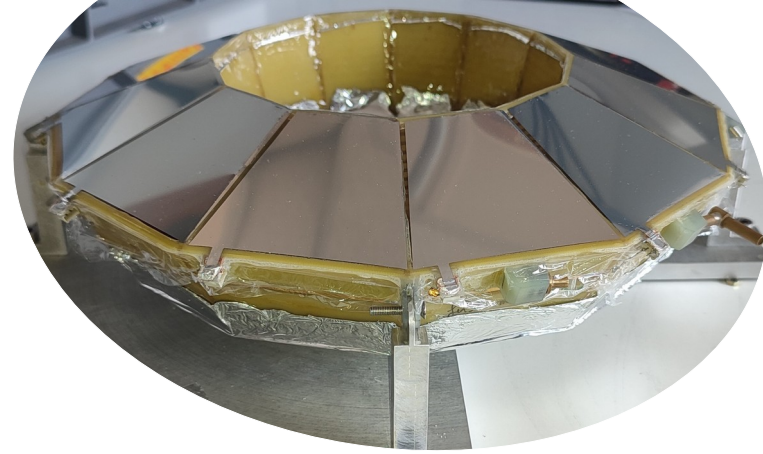

## INDRA classic GANIL

### Publications

A. Rebillard-Soulié,  
J. Phys. G 2024

### PhD thesis

A. Valente

## INDRA classic GSI

### PhD thesis

T. Génard (2023)  
S. H. Nam

## INDRA-VAMOS GANIL

### Publications

Q. Fable, PRC 2022  
Q. Fable, PRC 2023  
Q. Fable, PRC 2024

## FAZIA 4-6b LNS

### Publications

S. Piantelli, PRC 2023  
C. Frosin, PRC 2023  
S. Upadhyaya, EPJA 2024

### PhD thesis

S. Upadhyaya (2022)

## INDRA-FAZIA GANIL

### Publications

C. Ciampi, PRC 2022  
C. Ciampi, PRC 2023  
C. Ciampi, in preparation

### PhD thesis

C. Ciampi (2022)  
J. Lemarié (2022)  
S. H. Nam  
A. Rebillard-Soulié  
L. Baldesi

## FAZIA 4b RAON



## FAZIA@RAON

Building 4 complete blocks dedicated to RAON with updated front-end electronics designed and built in Korea. Silicon detectors built and tested in Korea while the mechanics and scintillators from Europe.

→ See G. Kim's talk

## RAON activities

FAZIA blocks ready to participate in the RAON commissioning by next year

→ Ar beam at  $\sim 18$  MeV/nuc.

→ Light fragmentation beams selected by KoBRA

→ Light ISOL beams (>2025)

→ High energy beams after SCL2 upgrade (>2030)

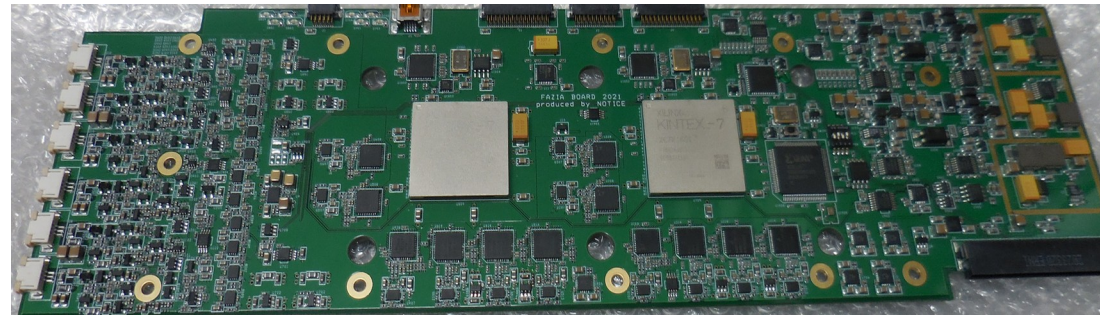
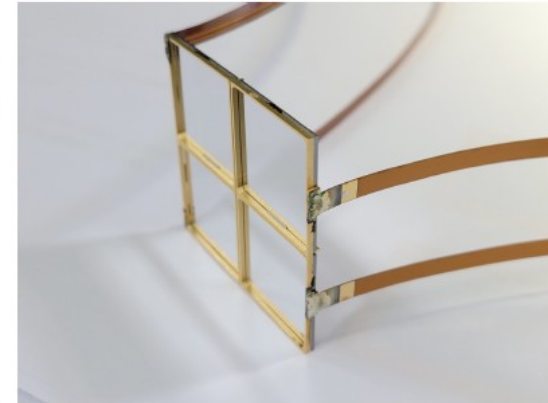
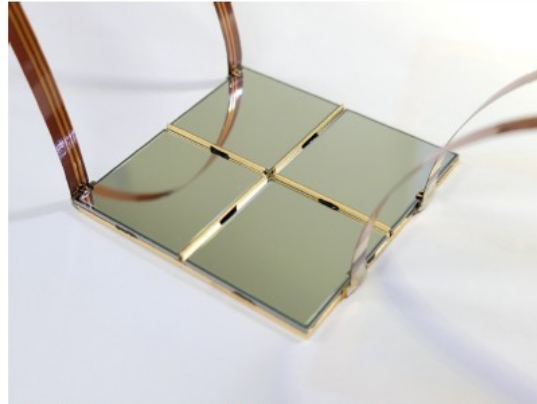

## INDRA classic GANIL

### Publications

A. Rebillard-Soulié,  
J. Phys. G 2024

### PhD thesis

A. Valente

## INDRA classic GSI

### PhD thesis

T. Génard (2023)  
S. H. Nam

## INDRA-VAMOS GANIL

### Publications

Q. Fable, PRC 2022  
Q. Fable, PRC 2023  
Q. Fable, PRC 2024

## FAZIA 4-6b LNS

### Publications

S. Piantelli, PRC 2023  
C. Frosin, PRC 2023  
S. Upadhyaya, EPJA 2024

### PhD thesis

S. Upadhyaya (2022)

## INDRA-FAZIA GANIL

### Publications

C. Ciampi, PRC 2022  
C. Ciampi, PRC 2023  
C. Ciampi, in preparation

### PhD thesis

C. Ciampi (2022)  
J. Lemarié (2022)  
S. H. Nam  
A. Rebillard-Soulié  
L. Baldesi

## FAZIA 4b RAON

### PhD thesis

J. Park  
G. Kim



## INDRA-FAZIA@GANIL

Two more experiments in 2025. At least two experiments re-proposed at the next PAC.

## FAZIA@RAON

Deliver the four blocks and participate in the RAON commissioning.

## FAZIA@FRIB

Internal discussion to propose/participate in experiment at FRIB with spare FAZIA blocks or with dedicated new detectors ?

→ See round table's discussions

RAON



GANIL

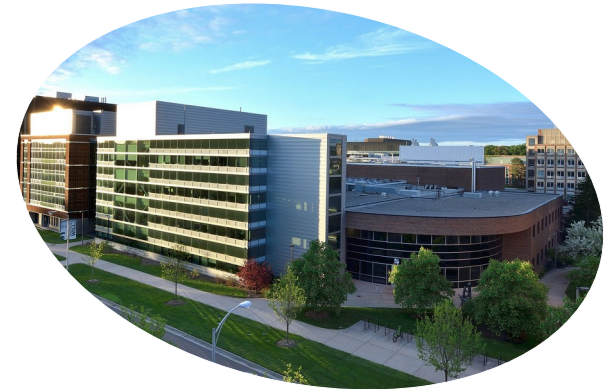

 Abdou Chbihi, Caterina Ciampi, **John Frankland**, Rémi Bougault, Dominique Durand, Diego Gruyer, **Nicolas Le Neindre**, Olivier Lopez, Alex Rebillard-Soulié, Antonin Valente, Emmanuel Vient, Bernard Borderie, Emmanuelle Galichet, Quentin Fable, Eric Bonnet

 Sandro Barlini, Lucia Baldesi, Alberto Camaiani, **Giovanni Casini**, Gabriele Pasquali, Silvia Piantelli, Giacomo Poggi, Andrea Stefanini, Simone Valdré, Daniele Dell'Aquila, Mariano Vigilante, Ivano Lombardoi, Giuseppe Verde, Magda Cicerchia, Fabiana Gramegna, Tommaso Marchi

 Tomasz Kosik, Katarzyna Mazurek, Andrzej Kordyasz

 José Dueñas

 Byungsik Hong, MinJung Kweon, Jong-Won Lee, Sunji Kim, Seon Ho Nam, Jeonghyeok Park, Giyeong Kim

