



HAL
open science

The Billotron: a way to experimentally apprehend the subatomic world

A. Chapon, J. Gibelin, O. Lopez, D. Cussol, D. Dominique Durand, Ph. Desrues, H. Franck de Préaumont, Y. Lemièrè, J. Perronnel, J.C. Steckmeyer

► **To cite this version:**

A. Chapon, J. Gibelin, O. Lopez, D. Cussol, D. Dominique Durand, et al.. The Billotron: a way to experimentally apprehend the subatomic world. *Physics Education*, 2015, 50 (4), pp.453. <10.1088/0031-9120/50/4/453>. <in2p3-01177619>

HAL Id: in2p3-01177619

<https://in2p3.hal.science/in2p3-01177619v1>

Submitted on 17 Mar 2020

HAL is a multi-disciplinary open access archive for the deposit and dissemination of scientific research documents, whether they are published or not. The documents may come from teaching and research institutions in France or abroad, or from public or private research centers.

L'archive ouverte pluridisciplinaire **HAL**, est destinée au dépôt et à la diffusion de documents scientifiques de niveau recherche, publiés ou non, émanant des établissements d'enseignement et de recherche français ou étrangers, des laboratoires publics ou privés.



Distributed under a Creative Commons CC BY 4.0 - Attribution - International License

PAPER

The Billotron: a way to experimentally apprehend the subatomic world

To cite this article: A Chapon *et al* 2015 *Phys. Educ.* **50** 453

View the [article online](#) for updates and enhancements.

Related content

- [A Rutherford alpha particle scattering analogue](#)
P M Lee, H M Montagu-Pollock and A Perkins
- [How do we know what is 'inside the atom'?—Simulating scattering experiments in the classroom](#)
E S Cunningham
- [Screened Coulomb scattering versus Thomson scattering](#)
Pascal Monceau, Thomas Szydlo and Galliano Valent

Recent citations

- [Rutherford visits middle school: a case study on how teachers direct attention to the nature of science through a storytelling approach](#)
Lena Hansson *et al*



IOP | ebooks™

Bringing you innovative digital publishing with leading voices to create your essential collection of books in STEM research.

Start exploring the collection - download the first chapter of every title for free.

The Billotron: a way to experimentally apprehend the subatomic world

A Chapon, J Gibelin, O Lopez, D Cussol, D Durand,
Ph Desrues, H Franck de Préaumont, Y Lemière, J Perronnel and
J C Steckmeyer

LPC Caen, ENSICAEN, Université de Caen, CNRS/IN2P3, Caen, France

E-mail: cellule-com@lpccaen.in2p3.fr



CrossMark

Abstract

The Billotron is a device designed and built by the LPC Caen to illustrate the methods with which physicists are able to study the basic structure of matter, in particular the nucleus of the atom.

1. Introduction

Atoms, nuclei, and particles are so small ($< 10^{-9}$ m) that they cannot be observed through any usual optical devices like lenses or microscopes. Using an interactive device called the Billotron¹, we explain how scattering (and in particular Rutherford scattering) can be used to probe matter and therefore allow physicists to study the invisible world of subatomic physics. The device described here is an extension of similar models built, for example, in RIKEN, Japan, or KVI in the Netherlands. Our model is, however, an interactive general public experiment that includes and illustrates all the steps of a real nuclear or particle experiment. It is also complemented by a 3D interactive simulation in order to exhibit the link between theoretical and experimental works as performed in a real experiment.

After introducing Rutherford scattering, we describe the device and its applications. We then compare the results with a Monte Carlo simulation specifically developed for this application. We conclude with a quick summary of a typical presentation.

¹ Portmanteau word: from 'bille'—marble in French—and '—tron'—suffix of 'cyclotron'.

2. Rutherford scattering

At the beginning of the 20th century, the structure of the atom was largely unknown. J J Thomson, discoverer of the electron a few years previously, proposed a model of an atom where the positive charges were spread out inside the whole atomic sphere where the electrons were embedded [1]. It was the so-called plum-pudding model. If this model were correct, the positive charges would not be able to exert a strong Coulomb force when charged particles passed through the atom, and the latter should exhibit small deflection angles from the incident direction.

To elucidate this point, an experiment was performed in 1909 by Geiger and Marsden [2], under the direction of Rutherford, where they directed a collimated alpha particle beam onto very thin gold foil. They showed that a small amount of the alpha particles (around 1 out of 8000) impinging on the gold foil were strongly deflected at very large angles, i.e. over 90°, opposite to what one would expect from the plum-pudding model.

Rutherford solved this problem in 1911 [3] by assuming that the positive charges have to be concentrated in a very small region of the atom, in order to produce a Coulomb field strong enough

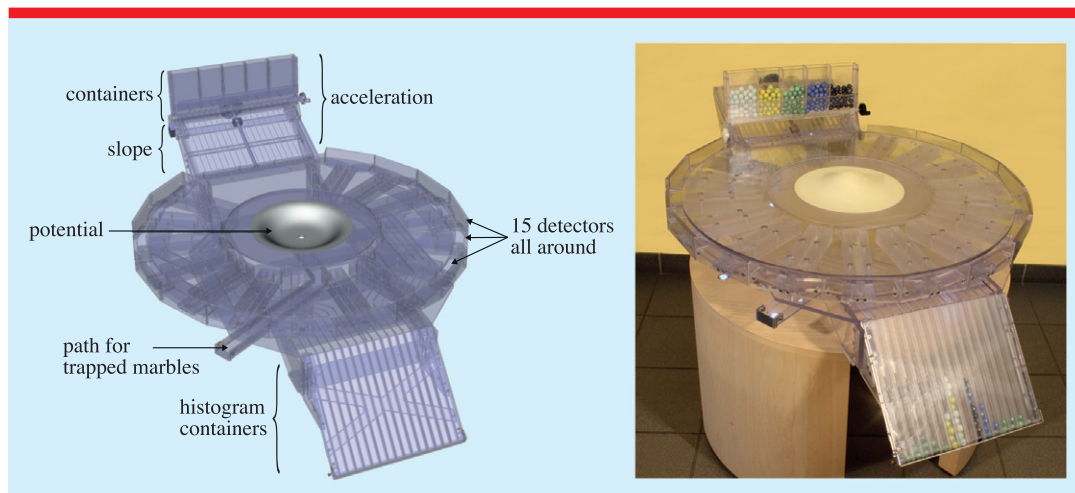

Figure 1. Left: schematic of the Billotron, showing the different parts. Right: picture of the device.

to scatter the alpha particles at large angles. By taking the ratio of these largely deflected particles, he also concluded that the size of the small positively charged region was below 10^{-14} m. It was the first evidence of the internal atomic structure, and the discovery of the nucleus; one can say that nuclear physics was truly born at this moment.

However, the alpha kinetic energies used by Rutherford allowed him to solely measure the repulsive interaction of the electromagnetic force between the alpha probe ($Z = 2$) and the gold nuclei ($Z = 92$). Later in the century, the use of accelerators allowed physicists to increase the probes' velocity and to come closer to the nuclei, hence probing the attractive strong interaction.

3. Principle

In this demonstration experiment, alpha particles are replaced by marbles (~ 1 cm diameter) sent onto bigger structures (~ 10 cm diameter, so-called 'potentials' in the following, see figure 2), where they will be scattered. The experiment is repeated several times in order to accumulate statistics, count the number of marbles scattered at a given angle, and build the corresponding angular distribution. Finally, the results are compared with specifically designed simulations (see section 4).

Nuclear or particle physics experiment are usually a long process that involve several areas of technical expertise. Here the design and the construction of the Billotron also results from our engineers' and technicians' work based on realistic simulations, illustrating the way fundamental physics experiments are built. As shown in figure 1, the Billotron is made of two trays; the upper one is the scattering plane hollowed in the centre to place the potentials, the lower one is made to collect and guide the marbles into a downstream piece called the histogram container. At the periphery of the upper tray, 15 collectors are placed, acting as detectors. They cover an angular range of 20 degrees each, and are allowed to cover 300 degrees over the 360 of the total angular range; the remaining non-covered 60 degrees are occupied by the slope for the marbles at backward angles; this slope is here as a 'launchpad' for the marbles, and can be assimilated to a particle accelerator where the energy can be adjusted, as we will see in the following section. More details can be seen in figure A1 in the appendix. All the pieces are made in a 10 mm polycarbonate translucent material, and have been designed and built using the same tools as for a nuclear experiment: the 3D design software CATIA from Dassault Systems for the design and numerical drilling and cutting machines of the lab workshop for the construction were used. Both phases (design and construction) took about four months FTE for our technical services.

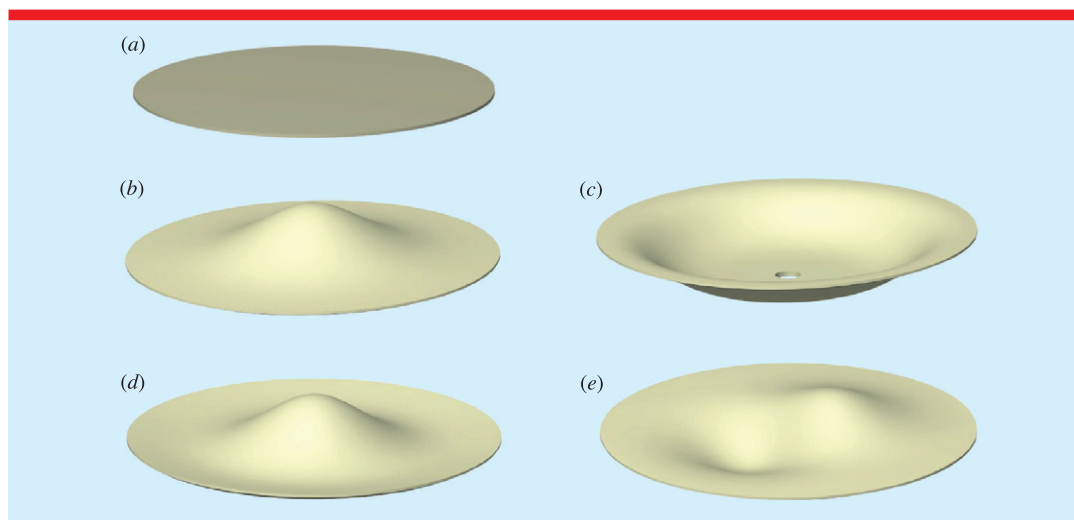

Figure 2. The five potentials used: (a) flat, (b) bump, (c) well, (d) reverse ‘Mexican hat’ and (e) asymmetric. See text for details.

3.1. Acceleration

Any scattering experiment requires a (fast) moving probe. Although this is not a problem for photons, one must in the case of particles (electrons, nuclei etc) accelerate them, usually by applying an electric potential difference. Here our marbles not being charged, the acceleration is obtained by dropping them from a reservoir with separate containers onto a slope (see figure 1 and appendix A).

The angle of the slope is kept constant and the marbles are placed in containers at the same height in the reservoir. In order to allow the user to change the resulting velocity, they can be slid down the slope from different heights. Mechanically, five separated containers allow the use of five different colours for the marbles so as to distinguish the traces for different impact parameters. To drop the marbles regularly and avoid clutching the device, they are ejected from the containers using a specifically designed worm drive rotated by hand.

3.2. Scattering potentials

As stated above, the device extends the initial concept by allowing the user to change the scattering potentials.

In total, five 20 cm wide potentials were engineered according to simulation (see section 4). They were made of epoxy resin from fast

prototyping. Figure 2 presents the five potentials we describe here.

- The first one—figure 2(a)—is flat in order to show the result without interaction.
- The potential showed in figure 2(b) is convex so as to simulate a repulsive potential. Rolling marbles hit it and are deflected away from the centre. If they have enough velocity (energy), however, they are able to pass the bump, allowing the illustration that the potential height (or depth) can be probed by changing the energy of the incoming particles. This potential is designed to illustrate Rutherford scattering and scattering at large angles.
- The third one is an attractive concave potential, see figure 2(c). This one is used to simulate attractive interaction, like the strong force that binds the nucleus. Here, balls can be scattered in both directions. They can also be trapped in the well and an exit hole has been punched to avoid the marbles accumulating. This simulates nuclear fusion, especially the neutron capture that occurs in nuclear reactors before the fission of the uranium.
- The fourth (figure 2(d)) is attractive at its periphery and repulsive at its centre. It was designed to simulate the combined effect of the Coulomb and the strong interaction. In principle the corresponding potential for a nucleus must be repulsive at a long distance

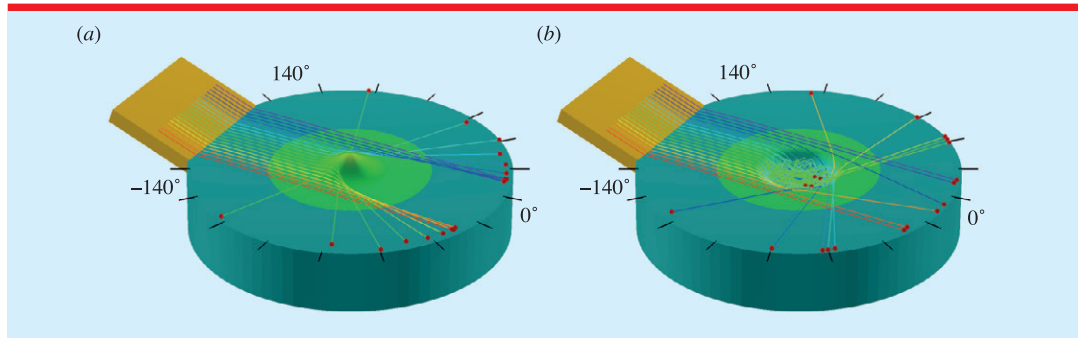

Figure 3. The marbles' trajectories in the scattering plane. Left for the repulsive potential, and right for the attractive one.

(Coulomb repulsion) and attractive in its centre (strong interaction), but our simulations showed that such a potential will be difficult to use in our case to obtain reasonable results. We thus decided to invert the repulsive and attractive configuration. This potential is nevertheless designed to describe the combination of attractive and repulsive areas when a particle hits a nucleus (the so-called 'Mexican hat').

- The last one (figure 2(e)) is asymmetric (a bump and well separated by a distance greater than their sizes) to illustrate the effect of polarized experiments, as well as to convince the public that unpolarized nuclei make symmetric angular distribution.

3.3. Detection and analysis

All the scattered marbles are collected by 15 manifolds symmetrically placed all around the scattering area. The marbles are then stored in front of the device by 15 receptacles, each one directly corresponding to a scattering angle in order to build the angular distribution histogram. This part of the device is removable and exists in several copies so the speaker can circulate it through the audience for discussion. The resulting histograms are then compared with simulations, as described in the next section.

4. Simulation

4.1. Description

The simulation of the Billotron relies on a custom-made physical package for the computation

of the marbles' trajectories and on the ROOT [4] framework for the display following two steps. The trajectories of the marbles are then first computed using a physical package; then the corresponding coordinates are displayed, with the resulting angular distribution.

The physical package consists of a collection of C++ classes that can handle the description of the physical interactions and description of the particles that are sensitive to these physical interactions. The classical equations of motion are numerically solved through a fourth order Runge–Kutta algorithm with an adaptive time step [5]. For the Billotron, the interaction is simply a uniform gravitational field and the proper counter-reaction of surfaces. In order to avoid discontinuities in the numerical treatment, an additional component has been added to the reaction of the surfaces. This component is proportional to the penetration depth of the marble at the surface. Then the marble experiences at all times two interactions:

$$\begin{aligned}\vec{F}_{\text{grav}} &= -mG\vec{u}_z \\ \vec{F}_{\text{surface}} &= [-\vec{F}_{\text{grav}} \cdot \vec{u}_n + k \times d_n]\vec{u}_n \\ \vec{F}_{\text{total}} &= \vec{F}_{\text{grav}} + \vec{F}_{\text{surface}}\end{aligned}\quad (1)$$

where \vec{F}_{grav} , \vec{F}_{surface} and \vec{F}_{total} are, respectively, the gravitational force, the counterreaction of the surface and the resulting total force, m the marble mass, G the gravitational constant ($9.81 \text{ m} \cdot \text{s}^{-2}$), \vec{u}_z the unit vector oriented from down to top, \vec{u}_n the unit vector perpendicular to the surface at the

The Billotron: a way to experimentally apprehend the subatomic world

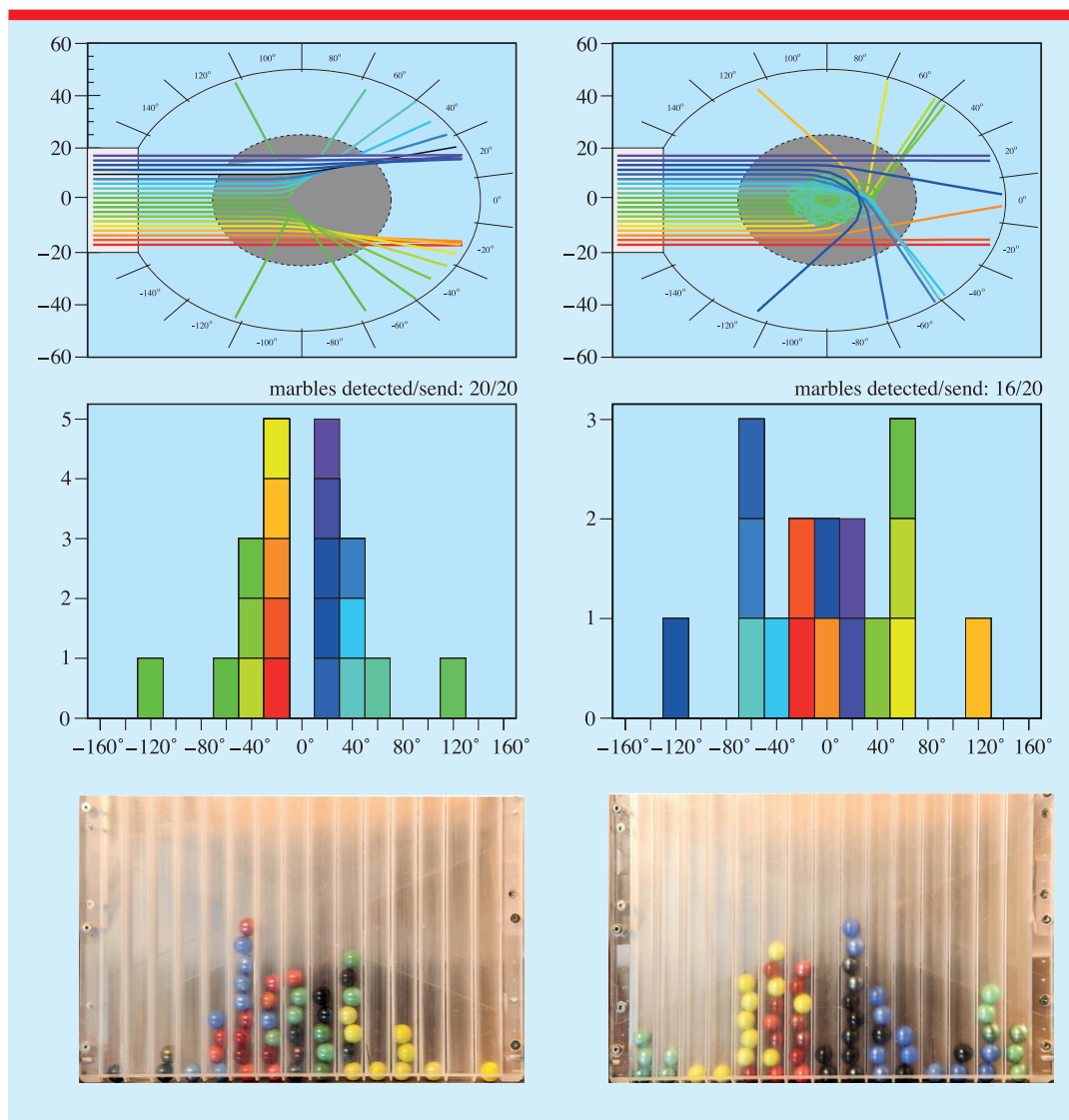

Figure 4. Trajectories (top) and the resulting distributions for the simulation of 20 marbles (middle) obtained with: (left) a repulsive (bump) potential and (right) attractive (concave) potential. In this last case, some of the marbles are trapped in the potential. The bottom distributions show the experimental results (60 marbles launched) as obtained with the Billotron. Note that the device allows only five colours: red, yellow, green, blue, and black, instead of the simulated red to violet rainbow.

marble coordinates, d_n the penetration depth of the marble in the surface, and k a rigidity constant. The penetration depth d_n is simply the difference between the radius of the marble and the distance of its centre to the surface.

The display part of the program is based on the geometry classes of the ROOT framework. Each element of the Billotron has been described

by using simple shapes (boxes and tubes) and the marbles with simple spheres. The potential is displayed by dividing the corresponding surface elemental into small triangles. Hence all the potentials built for the real Billotron have been implemented in its numerical version. A display of the numerical avatar of the Billotron is shown in figure 3.

A graphical user interface has been built to make the use of the simulation easy. The user can set the initial height of the marbles on the acceleration ramp and can also choose a pre-defined potential by selecting this potential in a pull down menu. A push button triggers the computation of the trajectories followed by the display of these trajectories and the resulting angular distribution. When the 'random potential' item is chosen, a potential is randomly chosen among the list of the five pre-defined potentials, and this potential is hidden inside a sphere when the trajectories are displayed. This allows the user to guess the shape of the potential from the angular distribution.

4.2. Results

We present in figure 4 the results obtained with the potentials of figure 2(b) (repulsive) and figure 2(c) (attractive). The marbles' trajectories are shown in figure 3.

As expected, depending on the type of central potential as well as the incoming velocity, we notice that the marbles are not scattered at the same angles. By looking at the angular distribution, one can then bring information about the scattering object placed at the centre of the device. Indeed, if we look at these distributions, we clearly see differences as illustrated by figure 4.

During an interactive experiment session (see section 5), the speaker will use at least two of the potentials, perform the experiments, and collect the corresponding angular distributions, which have to be finally compared with the simulation. Before using them, they can comment on the differences observed in the angular distributions with both potentials. We can notice that the marbles coming from different slope containers, hence associated with different impact parameters (colours), have different scattering angles. For example, marbles coming with small impact parameters (centre) are systematically backward-scattered with the repulsive potential, while not with the attractive one, as seen in figure 4. We also observe a depletion at forward angles for the repulsive potential, which is not so large for the attractive one. Obviously, these

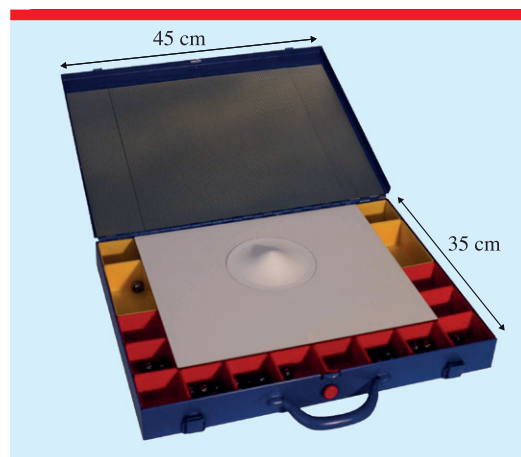

Figure 5. Picture of the Billotrino, the small portable brother of the Billotron.

features depend on the height (velocity) where the marbles are launched. By adjusting it, one can optimize the differences between these two potentials to emphasize the effects. More results are presented in figure B1 in the appendix.

5. Typical presentation

Here, we describe a typical presentation as performed in front of a general audience. Note that the device is well adapted to young people (over five years of age) due to its height (≈ 70 cm) and the presence of coloured marbles, but brings quite elaborate information suitable for adults too. This point is very important and makes the presentation suitable for a large (family) audience, from children to seniors.

A typical presentation will start by using the 'bump' potential—figure 2(b)—which illustrates the initial Rutherford experiment, with a marble's velocity such that they can not pass over the potential. The speaker usually starts by dropping one marble at a time at different impact parameters so the public can apprehend typical trajectories and especially 180° recoils. Then several balls are accelerated at once to accumulate statistics. This step is usually performed by someone from the audience. The resulting histogram (figure 4 (left, bottom)) is then analyzed with the audience and compared to the simulation (figure 4 (left, middle)).

The Billotron: a way to experimentally apprehend the subatomic world

Then, after this first experiment, we usually change the potential to the well—figure 2(c)—and place a new receptacle for the histogram, keeping the one previously produced. Before starting the experiment the audience is asked to guess the result, which will at the end be compared to the first experiment by placing the two resulting histograms side by side. Here again, comparison with the simulations are performed (figure 4 (right)).

The main conclusion is that the ‘bump’ potential generates an angular distribution with a depletion at a forward angle contrary to the well, which tends to forward focus the marbles. These two pictures are somehow the ‘negative’ image of the potential: not the real shape of the potential but characteristic enough that the real shape of the potential can be guessed with the help of models and simulations.

Here, with the balls being coloured differently depending on their impact parameters, it is possible to show that in the case of the bump left (respectively right) the marbles stay on the left (right), but in the well case left (respectively right) the interacting marbles deviate to the right (left).

A poster where the correspondence between the principal potentials, the initial heights of the marbles, and the resulting angular distributions, presented in figure B1, is used during the presentation so that even young children can make guesses on the results.

6. Extension: the Billotrino

This device is well suited for exhibitions, science festivals, full-day classroom presentations, or open houses in a laboratory, but its size (1 m diameter) and weight (around 50 kg) prevent a sole speaker from bringing it for quick presentations—for example lectures at middle or high schools, or colleges.

This is why a smaller version using material easily available at any hardware store, nicknamed the Billotrino², was then built. It fits into a small portable suitcase, as one can see in figure 5. In the version presented here, the main component is a removable compartment organizer. The potential has been made by hand

using hardened play dough on wooden plate, but a 3D printer can also be used. As is, it can then easily be built in school under the teacher’s supervision.

Acknowledgments

The Billotron was funded through the ‘Têtes chercheuses’ prize given by ‘La Fondation Musée Schlumberger’ and ‘Relais d’Sciences’.

Appendix A. Overviews of the device

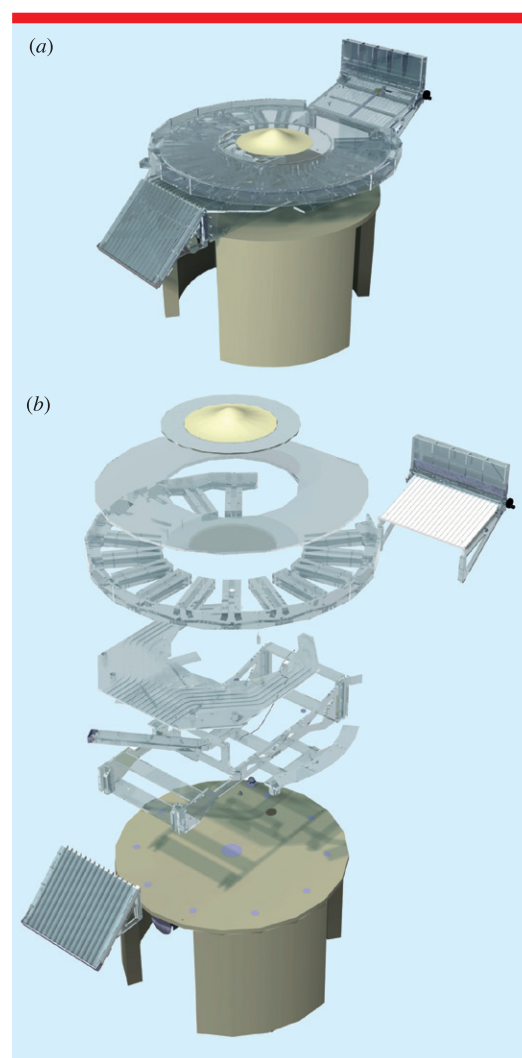

Figure A1. Complete (a) and exploded (b) views of the Billotron showing the different layers and trays.

² ‘The little Billotron’ in Italian; in the same vein Fermi coined the term neutrino to avoid confusion with the neutron.

Appendix B. Simulation results for different configurations

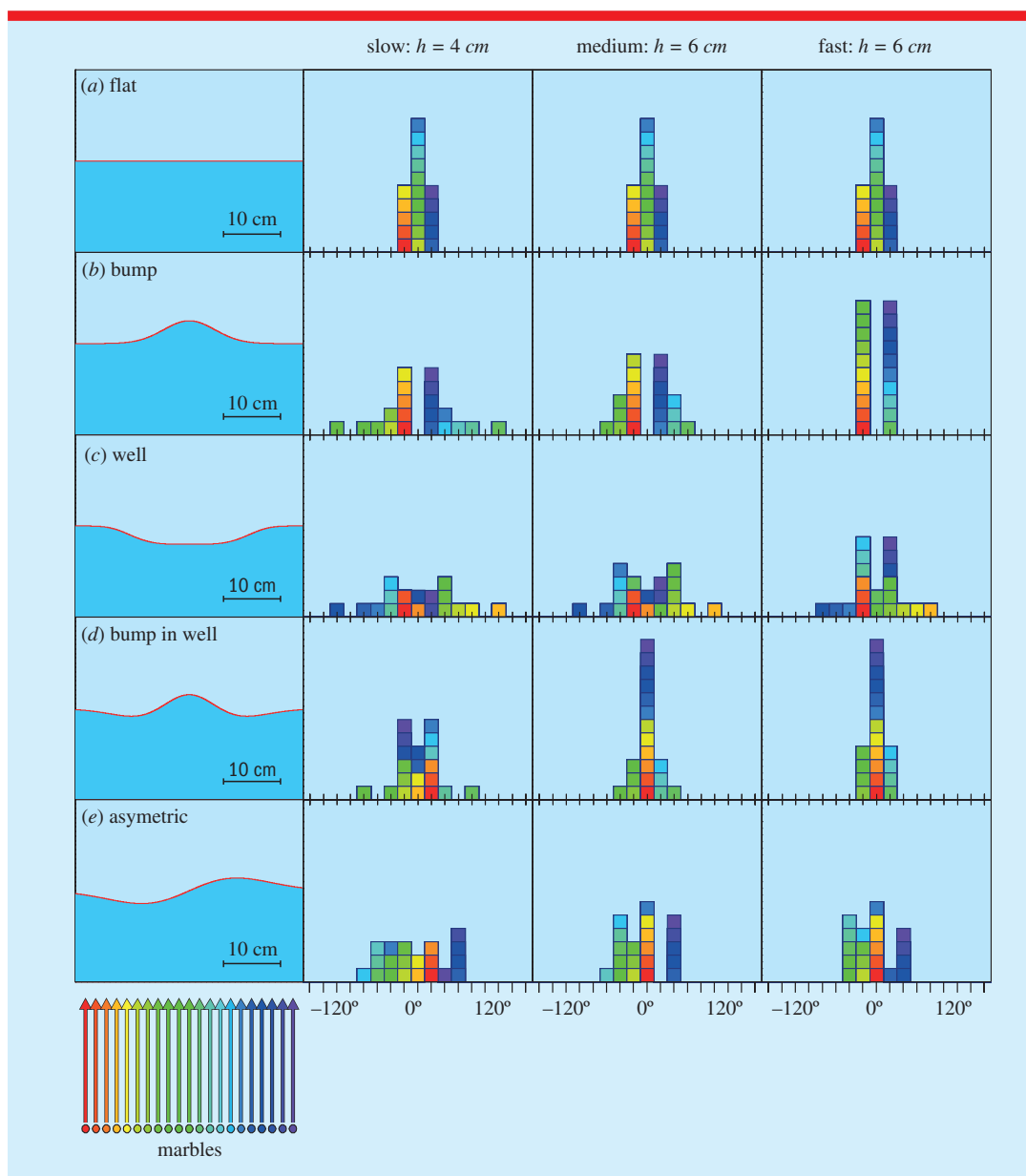

Figure B1. Angular distributions obtained from simulation with 20 marbles, for all the potentials described in section 3.2 and for different marble energies, corresponding to the height h (in the column).

Received 15 November 2014, in final form 7 April 2015
 Accepted for publication 16 April 2015
[doi:10.1088/0031-9120/50/4/453](https://doi.org/10.1088/0031-9120/50/4/453)

References

[1] Thomson J 1904 *Phil. Mag. Ser. 7* 237
 [2] Geiger H and Marsden E 1909 *Proc. R. Soc.* **82** 495
 [3] Rutherford E 1911 *Phil. Mag. Ser. 21* 669
 [4] Brun R and Rademakers F 1997 *Nucl. Instrum. Methods Phys. Res.* **389** 81–86 www.sciencedirect.com/science/article/pii/S016890029700048X
 [5] Press W H, Teukolsky S A, Vetterling W T and Flannery B P 2007 *Numerical Recipes (The Art of Scientific Computing vol 3)* 3rd edn (Cambridge: Cambridge University Press)

The Billotron: a way to experimentally apprehend the subatomic world



Standing, from left to right: Ph Desrues, D Cussol, B Bougard, J Perronnel, C Pain, H Franck de Préaumont and D Durand. Kneeling, from left to right: O Lopez, J Gibelin, A Chapon and Y Lemière. **A Chapon**, **O Lopez** and **D Cussol** are researchers at CNRS in France. **J Gibelin** and **Y Lemière** are assistant professors at the University of Caen-Basse Normandie in France. **D Durand** and **J C Steckmeyer** are the current and former directors of the LPC and are researchers at CNRS. **H Franck de Préaumont** is an engineer specializing in 3D conception. **Ph Desrues**, **C Pain**, **B Bougard** and **J Perronnel** are technicians.