



HAL
open science

Using ultra fast analog memories for fast photo-detector readout

D. Breton, J. Maalmi, P. Rusquart, E. Delagnes, H. Grabas

► **To cite this version:**

D. Breton, J. Maalmi, P. Rusquart, E. Delagnes, H. Grabas. Using ultra fast analog memories for fast photo-detector readout. International Workshop on New Photon-Detectors (PhotoDet 2012), Jun 2012, Orsay, France. pp.028. in2p3-00727476

HAL Id: in2p3-00727476

<https://in2p3.hal.science/in2p3-00727476v1>

Submitted on 21 Mar 2013

HAL is a multi-disciplinary open access archive for the deposit and dissemination of scientific research documents, whether they are published or not. The documents may come from teaching and research institutions in France or abroad, or from public or private research centers.

L'archive ouverte pluridisciplinaire **HAL**, est destinée au dépôt et à la diffusion de documents scientifiques de niveau recherche, publiés ou non, émanant des établissements d'enseignement et de recherche français ou étrangers, des laboratoires publics ou privés.

Using ultra fast analog memories for fast photo-detector readout.

Dominique Breton¹

Laboratoire de l'Accélérateur Linéaire, CNRS/IN2P3, Orsay, France

E-mail: breton@lal.in2p3.fr

Eric Delagnes

CEA/IRFU Saclay, France

E-mail: eric.delagnes@cea.fr

Hervé Grabas

CEA/IRFU Saclay, France

E-mail: herve.grabas@cea.fr

Jihane Maalmi

Laboratoire de l'Accélérateur Linéaire, CNRS/IN2P3, Orsay, France

E-mail: jmaalmi@lal.in2p3.fr

Pascal Rusquart

Laboratoire de l'Accélérateur Linéaire, CNRS/IN2P3, Orsay, France

E-mail: rusquart@lal.in2p3.fr

The recent progresses in the field of photo-detection have pushed the performances of the detectors toward the picosecond scale. Necessary precise charge and time measurements are mainly based on high-end oscilloscopes or commercial modules, but these solutions are expensive and house very few channels.

The USB-WaveCatcher boards are high performance digitizers based on ultra fast analog memories. The boards house up to 16 channels of 12-bit 500-MHz-bandwidth digitizers sampling up to 3.2 GS/s. Their low consumption allows the 2-channel version to be USB-powered and they offer a lot of functionalities. The boards have been used in numerous test benches dedicated to fast MCP-PMTs or SiPMs, and a reproducible time precision better than 10 ps rms has been demonstrated.

The USB-WaveCatcher boards thus seem to be a wonderful tool for photo-detector characterization. The current developments focus on a wide expansion of the number of channels, while keeping the 10-ps time precision. A 64-channel system has already been designed.

*International Workshop on New Photon-detectors,
LAL Orsay, France
June 13-15, 2012*

¹ Speaker

1. Introduction

Photo-detectors are implied in all kinds of applications. Associated electronics can be used either for their characterization (test benches) or for their readout (physics experiments or medical apparatus). In the case of test benches, ultimate performance of the electronics is requested. If the number of channels is small (≤ 4), then high-end oscilloscopes can be used. But if the number of channels increases, and if one wants to study all of them in parallel, difficulties occur. In the case of physics experiments, dedicated ASICs are usually used. They shape the signal and then permit amplitude (A), charge (Q) and/or time (T) measurement. But if time measurement precision has to be better than 30 ps rms, or if one wants to measure A, Q and/or T and also see the waveforms on demand, acquisition systems based on analog memories provide excellent solutions as it will be shown below with the description of the WaveCatcher boards.

2. ASIC and board developments.

2.1 The SAM family.

The SAM family ASICs are based on an analog matrix structure patented in 2001 [1]. The two current versions (SAM: 256 cells per channel [2], and SAMLONG: 1024 cells per channel) used on the WaveCatcher boards are shown on fig 1.

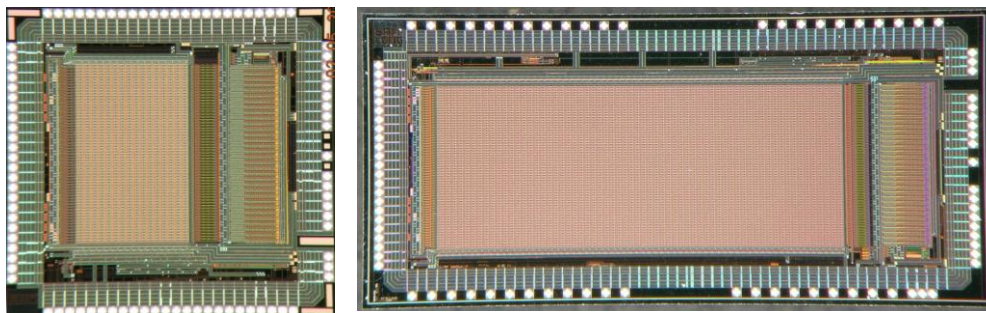

Figure 1: SAM and SAMLONG chips, 0.35 μ m technology, 2ch – 256/1024 cells/ch - 12bits - 3.2GS/s

They have been designed in a cheap pure CMOS 0.35 μ m technology and consume ~ 150 mW per channel. Their high dynamic range ($\gg 12$ bits) and high bandwidth (500 MHz) allow them to finely sample high speed signals like very short pulses, and make them very well suited for photo-detector readout. Moreover, thanks to the servo-controlled matrix structure, the time parameters are very well mastered thus offering an impressive sampling time precision, not so far from that of ultra-fast ADCs.

2.2 The WaveCatcher board.

The two-channel USB-WaveCatcher board [3] (see fig 2) has been designed to provide high performances over a short time window. It houses on a small surface two 12-bit 500-MHz-bandwidth digitizers sampling between 400 MS/s and 3.2 GS/s. It is based on the SAM chip family described hereabove. The board is DC-coupled with a unity gain, but can also be AC-coupled with a gain up to 15 (still offering 350 MHz of bandwidth). A DC offset can be added

at input in order to get a full benefit of the 2.5 V dynamic range, and an individual trigger discriminator is available on each channel. This permits a real time trigger counting independent of acquisition rate. The board is USB-powered and offers a lot of functionalities, like numerous coincidence trigger modes (useful for after-pulse studies) and an integrated pulse generator on each channel. It is also able to integrate the pulse charge onboard thus to provide very fast histogramming for multiple photon electron spectra. It houses a USB 480 Mbits/s interface permitting a dual-channel readout speed above 1k events/s.

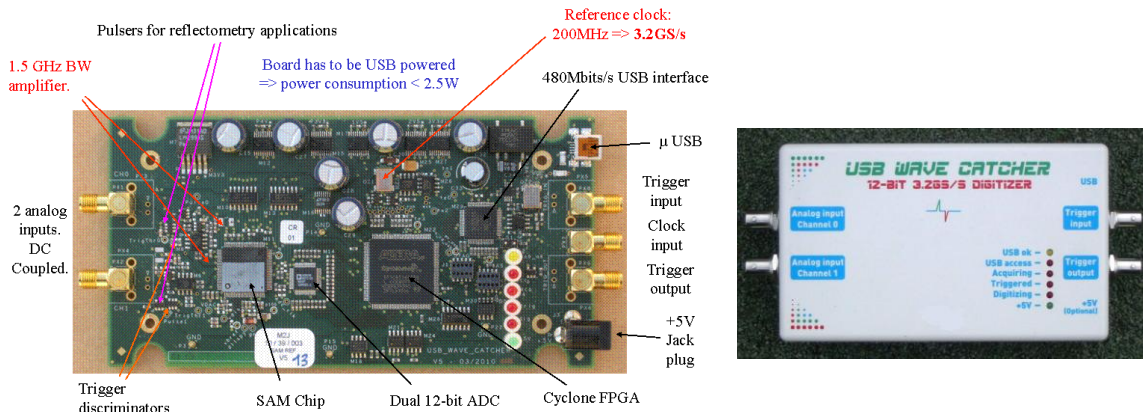

Figure 2 & 3: the USB-powered USB_WaveCatcher board (3.2GS/s, 12 bits, time resolution < 10ps rms)

The board was packaged in a friendly plastic box (see fig 3). This permits using it comfortably with a laptop, the latter being the source of power through the USB connection.

In parallel to hardware and firmware developments, and in order to offer to the board's users an easy way to use it, we developed a data acquisition software running on a PC and transforming the latter into an oscilloscope (see fig 4). It is currently used by most board users.

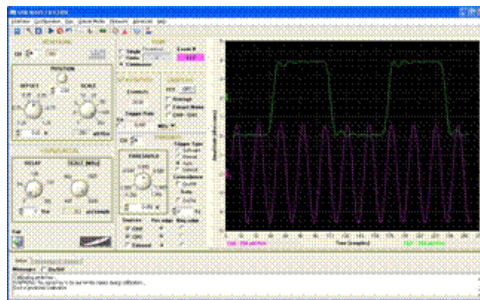

Figure 4: USB WaveCatcher acquisition software

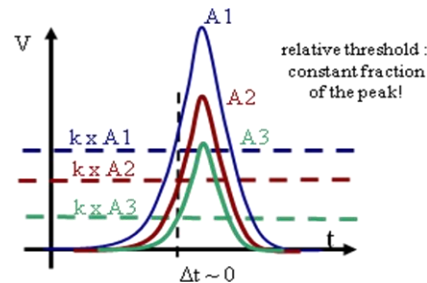

Figure 5: the digital CFD algorithm

The software described above embeds all features permitting an easy measurement and real-time histogramming of the time difference between two pulses, based on the digital CFD algorithm (see fig 5). Time precision results are shown on fig 7.

3. Towards high scale systems.

3.1 The 16-channel WaveCatcher crate.

An increasing number of people are using the WaveCatcher board worldwide on their test benches. But there was a rising request for equipping a larger number of channels. We tried to

see if this was possible while keeping the 10-ps rms time precision. Therefore, we designed a controller board which allowed us to drive and readout 8 WaveCatcher boards in parallel. The 9 boards were put in a crate and interconnected via SMA cables (see fig 6).



Figure 6: zoom on the 16-channel WaveCatcher crate

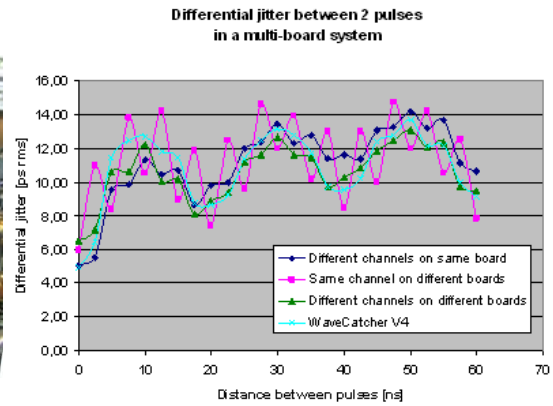

Figure 7: time performances

This crate proved the validity of the concept. Indeed, as shown on fig 7, the time precision obtained between any set of two boards is as good as that measured with a single WaveCatcher module (please note that to get the single pulse resolution, the values hereabove have to be divided by $\sqrt{2}$).

Two such 16-channel crates were built. One was used for measuring the time of flight of cosmic muons in a new type of detector based on crystal bars and ultra-fast MCP-PMTs at SLAC. This detector actually is a prototype of the Forward Time Of Flight detector of the future SuperB experiment. The second crate is used at LAL for the precise characterization of new prototypes of this kind of PhotoMultipliers (HAMAMATSU SL10 MCP-PMT).

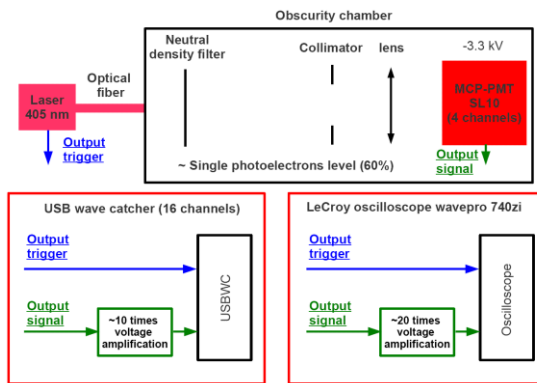

Figure 8: setup of the MCP-PMT test bench at LAL

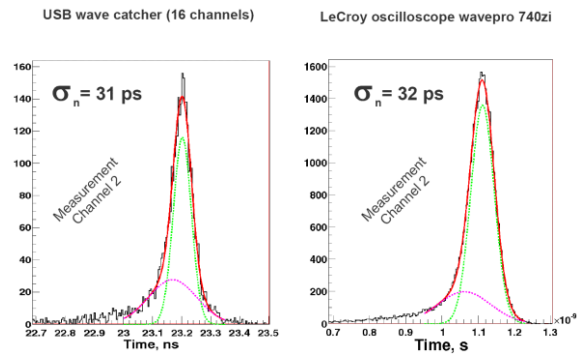

Figure 9: WaveCatcher module vs LeCroy oscilloscope

The setup used in the latter case is shown on fig 8. The laser light pulse is sent to the MCP-PMT and the output of the latter is compared with the trigger output of the laser. The measurement mostly performed on single photoelectrons with the high-end oscilloscope is compared to that done with the WaveCatcher board. Both results are shown on fig 9 and are perfectly equivalent.

3.2 The 16-channel WaveCatcher board.

The 16-channel crate data acquisition was rather slow because of the numerous USB interfaces connected to the same PC. However, the need for increasing the number of channels was obvious. Therefore, we designed a new 16/18-channel board (see fig 10) based on the SAMLONG chip. This board keeps the main features of the 2-channel module, but also offers new ones like a second discriminator and individual hit rate counters on each channel. In addition to the 16 analog inputs, 2 extra channels have been dedicated to the recording of digital signals. The architecture of the board has been designed in such a way to optimize the data readout rate. Despite the high number of channels, a rate of 1k full event/s can indeed be reached with the 480 Mbits/s USB interface.



Figure 10: the 16-channel WaveCatcher board

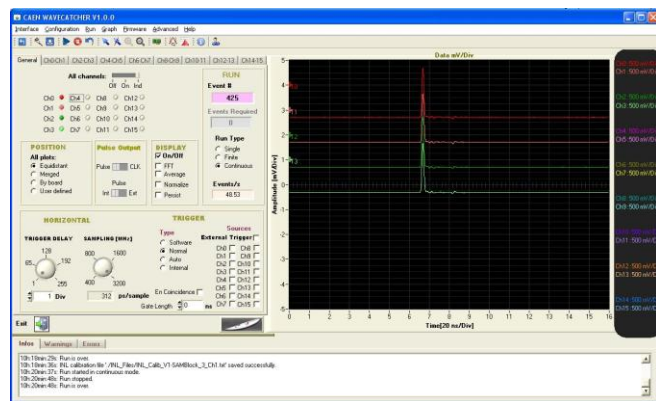

Figure 11: the 16-channel software

A new version of the 16-channel acquisition software was developed (see main panel on fig 11). It includes high speed data logging and many measurement features.

3.3 Still increasing the number of channels.

The 16-channel WaveCatcher board houses a 2-mm hard-metric backplane connector which allows it to be mounted in a crate and interconnected in order to build high scale systems.

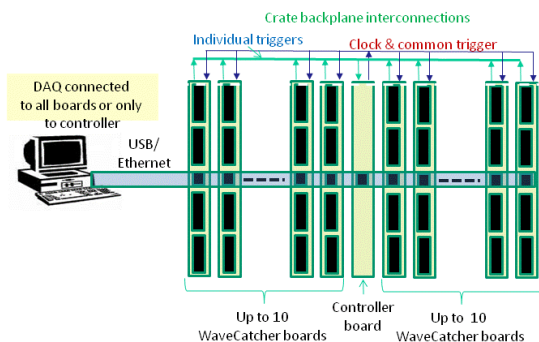

Figure 12: multi-board crate implementation

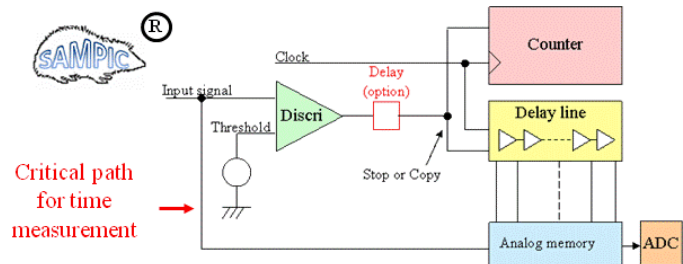

Figure 13: the 5-ps SAMPIC TDC

The goal remains here to keep the 10-ps rms precision. Two such systems have already been designed and are currently being tested. They both are based on many WaveCatcher

boards controlled and readout by a central controller board housing the central trigger logics, USB and Gbit-Ethernet interfaces (see fig 12):

- A 64-channel mini-crate making use of a 5-slot backplane. Its dimensions are as small as 11x26x30 cm³, those of a standard oscilloscope.
- A 320-channel crate where 20 WaveCatcher boards are connected to a 21-slot backplane. It will be used for the readout of the calorimeter of the SuperNemo experiment.

4. Future developments.

We now have all the necessary experience to design new analog memory ASICs, boards and systems targeting one or more of: a lower power consumption: < 100 mW/ch, a higher sampling frequency: ≥ 5 GS/s, a higher signal bandwidth: > 500 MHz, a greater sampling depth: > 1024 cells/ch, a higher density: more channels per chip, a better time precision: ≤ 5 ps rms, a higher modularity between the number of channels and their length.

The first circuit being designed is a new TDC called SAMPIC, for which AMS 0.18 μm CMOS technology has been chosen. The latter is based on a new patent filled in 2009. It will reach a precision of 5 ps over 16 channels. The novelty in the design is the addition of a high-performance analog memory to the usual structure of DLL-based TDCs (see fig 13), which relaxes the precision requirement on the discriminator. The first prototype should be delivered in early 2013.

5. Conclusion.

Photo-detectors are implied in all kinds of applications. Associated electronics can be used either for their characterization (test benches) or for their readout (experiments). In both case, and especially if the number of channels is high, analog-memory-based boards and systems seem to be the right solution. In this spirit, the WaveCatcher boards actually offer compact digitizing solutions between 2 and 16 channels together with a user-friendly software, already in use for many applications [4]. A compact 64-channel system has also been designed and will be available very soon.

References

- [1] D. Breton, E. Delagnes, *Fast analog sampler with great memory depth*, FR2824177 and US No. 6859375 patents.
- [2] E. Delagnes, Y. Degerli, P. Goret, P. Nayman, F. Toussenel, P. Vincent, Nucl. Instr. and Meth. A 567 (2006) 21.
- [3] D. Breton, E. Delagnes, J. Maalmi, *Picosecond time measurement using ultra fast analog memories*, in proceedings of TWEPP-09, *Topical Workshop on Electronics for Particle Physics, Paris, September 2009*.
- [4] D. Breton et al, Nuclear Instruments and Methods in Physics Research A 629 124 (2011) 123–132.