



HAL
open science

The Local Trigger Electronics of the ALICE dimuon trigger

G. Blanchard, P. Crochet, P. Dupieux

► **To cite this version:**

G. Blanchard, P. Crochet, P. Dupieux. The Local Trigger Electronics of the ALICE dimuon trigger. 2004, pp.1-114. in2p3-00020308

HAL Id: in2p3-00020308

<https://in2p3.hal.science/in2p3-00020308v1>

Submitted on 22 Jan 2004

HAL is a multi-disciplinary open access archive for the deposit and dissemination of scientific research documents, whether they are published or not. The documents may come from teaching and research institutions in France or abroad, or from public or private research centers.

L'archive ouverte pluridisciplinaire **HAL**, est destinée au dépôt et à la diffusion de documents scientifiques de niveau recherche, publiés ou non, émanant des établissements d'enseignement et de recherche français ou étrangers, des laboratoires publics ou privés.

THE LOCAL TRIGGER ELECTRONICS OF THE ALICE DIMUON TRIGGER

**G. Blanchard, Ph. Crochet, P. Dupieux,
for the Clermont-Ferrand group**

Laboratoire de Physique Corpusculaire de Clermont-Fd,
IN2P3/CNRS et Univ. Blaise Pascal de Clermont-Fd,
63177 Aubiere cedex, France

Abstract

This document has been prepared for the Production Readiness Review of the Local trigger electronics of the ALICE dimuon arm, LHCC milestones n° 429. It describes the design and the performances of a prototype board, developed at the LPC Clermont-Ferrand, in VME 9U format and based on programmable circuits.



Table of contents

1 INTRODUCTION	1
2 DESCRIPTION OF THE DIMUON TRIGGER	3
2.1 ORGANIZATION OF THE TRIGGER ELECTRONICS	3
2.2 CONTROL SIGNALS	4
2.3 READOUT STRIP SEGMENTATION	5
2.4 THE LOCAL BOARDS	8
2.4.1 <i>Numbering of the Local boards</i>	9
2.4.2 <i>Number of Local boards</i>	9
2.4.3 <i>Local/Regional crates in the ALICE cavern</i>	11
2.4.4 <i>Configuration of the Local boards</i>	11
2.4.5 <i>Particular case of the columns with 22 Local boards</i>	15
2.4.6 <i>Exhaustive list of the Local boards</i>	16
3 LOCAL TRIGGER ALGORITHM	17
3.1 BENDING PLANE L0-X	17
3.2 NON-BENDING PLANE L0-Y	19
3.3 COINCIDENCE WITH 4/4 MAJORITY	20
3.4 OUTPUT OF THE LOCAL LOGIC	20
3.5 PT CUT	20
4 LOCAL TRIGGER BOARD DESCRIPTION.....	22
4.1 THE “HISTORY”	22
4.2 THE PRESENT LOCAL TRIGGER BOARD	23
4.2.1 <i>Synoptic scheme and picture</i>	23
4.2.2 <i>Connectors</i>	23
4.2.3 <i>Programmable circuits</i>	26
4.2.4 <i>Miscellaneous devices</i>	27
4.2.4.1 LVDS receivers	27
4.2.4.2 Other differential devices	27
4.2.4.3 VME data.....	27
4.2.4.4 J3 Backplane.....	27
4.2.4.5 Look-Up-Table	28
4.2.4.6 Switches.....	28
4.2.5 <i>Printed circuit</i>	28
5 LOCAL TRIGGER BOARD FUNCTIONS.....	29
5.1 VME ADDRESSING	29
5.2 NORMAL MODE	29
5.2.1 <i>Registers systematically acquired</i>	29
5.2.2 <i>Additional registers acquired upon request</i>	30
5.3 LOADING MODE.....	32
6 INTERFACES	34
6.1 VME CRATES.....	34
6.1.1 <i>Slow-control and power supplies</i>	34
6.1.2 <i>J1 and J2 Backplanes</i>	35
6.1.3 <i>J3 Backplane</i>	41
6.2 REGIONAL BOARD AND FEE	44

7 LOCAL TRIGGER BOARD TESTS	45
7.1 TEST BENCH	45
7.1.1 <i>Test bench principle</i>	45
7.1.2 <i>Associated software</i>	46
7.1.3 <i>Bit pattern generator</i>	47
7.1.4 <i>Regional board emulator</i>	50
7.1.5 <i>Copy boards</i>	51
7.2 RADIATION TESTS WITH 14 MeV NEUTRONS.....	51
8 THE MINI-TRIGGER EXPERIMENT	53
9 CONCLUSIONS.....	57
9.1 PLANNING AND MILESTONES.....	57
9.2 MAINTENANCE AND SPARES.....	57
9.3 MANPOWER	58
9.4 FINANCIAL ASPECTS.....	58
ANNEXE 1: LOCAL BOARD TECHNICAL DRAWINGS.....	60
ANNEXE 2: SIGNAL TRANSMISSION FROM FEE TO LOCAL TRIGGER.....	69
ANNEXE 3: DECLUSTERING, SINGLES AND DOUBLES.....	73
DECLUSTERING	73
1) <i>Doubling of the bits</i>	73
2) <i>Declustering 2N-5</i>	73
a) Declustered even bits:.....	73
a) Declustered odd bits :	74
SINGLES AND DOUBLES COMPUTATION	75
ANNEXE 4: LOCAL BOARD CONFIGURATION (SEE §2.4.6).....	81
MAIN REMARKS DURING THE REVIEW AND PROPOSED SOLUTIONS :	112
ERRATA :	114

1 INTRODUCTION

ALICE [1] (A Large Ion Collider Experiment) will be the only detector dedicated to the study of nucleus-nucleus collisions at the LHC. Its physics program aims at investigating the properties of strongly interacting matter at extreme energy density where the formation of the Quark Gluon Plasma (QGP) is expected. Among the most promising probes of the QGP, heavy quarkonium states are especially relevant since they provide, via their leptonic decays, essential information from the earliest and hottest stages of heavy ion collisions. This has been an intensive field of research, from both experimental and theoretical sides, over the last years (for reviews, see [2,3]).

The ALICE detector will allow the reconstruction of quarkonium states both in the dielectron and in the dimuon channels. Dimuon measurements will be performed by means of a forward spectrometer [4,5] which is designed to identify a full set of resonances from the ϕ to the Υ , with high statistics and high resolution. The spectrometer covers the angular acceptance $2.5 < \eta < 4$. It consists of a front and a small angle absorber, a large dipole magnet, ten high granularity tracking chambers, a muon filter (iron wall) and a trigger system (Fig. 1-1).

The task of the trigger is to identify events of interest, namely events containing a dimuon, among all events. Since the main source of background comes from the low transverse momentum (Pt) muons from pion and kaon decay, the trigger decision relies on the Pt of the tracks measured in the trigger system. A dimuon trigger is issued if at least two tracks with Pt larger than a pre-defined threshold are detected within an event. To achieve this, the trigger system is based on two large area trigger stations located 16m and 17m from the IP¹. These stations, MT1 and MT2, are placed behind the thick iron wall which stops low energy background particles. Each station consists of two detection planes (30m² each) of 36 RPCs² [6] read-out in X and Y directions with a FEE³ dedicated chip. The signals coming from the FEE (X and Y fired strip patterns of the four detection planes) are sent to the Local trigger electronics, which is the object of this document. The whole system is divided in 234 detection areas, each of them being associated with a Local trigger board. The main task of the Local trigger electronics is:

- to perform the Local trigger algorithm and to deliver the trigger decision on single tracks. This is achieved by calculating the Pt of the track candidate and by comparing it to two pre-defined thresholds which correspond (in usual running conditions) respectively to the typical Pt of a muon from the decay of a J/ψ and a Υ ;
- to backup the input strip-pattern and the trigger decision at different level in the algorithm in a pipeline memory which is read out on occurrence of an ALICE trigger sequence.

The Local trigger information is then sent to the Regional trigger board (one per crate) and then to the Global trigger electronics which delivers a signal for single muons as well as for muon pairs for the whole trigger system. The dimuon trigger signal is involved in the level 0 (L0) of ALICE. This signal, acting generally as an early strobe, is delivered in 1.2 μ s to the detectors that require it.

The requirements for the Local trigger electronics are as follows:

- to work in "pipelined" mode at a frequency of 40MHz;

¹ Interaction Point.

² Resistive Plate Chambers.

³ Front End Electronics.

- to work with a total (fixed) latency less than 800ns (from the interaction to the CTP⁴ input) in order to leave time for the ALICE L0 decision to be built and transported to the detectors;
- to limit the dimuon rate to a maximum of 1kHz;
- to deliver a signal at low rate ($\leq 100\text{Hz}$) for rare events like high Pt muon pairs;
- to allow the algorithm as well as the pre-defined Pt cuts to be eventually modified and reloaded online depending on the running conditions.

This document presents a detailed status report of the Local trigger board in view of its production for the experiment. A description of the dimuon trigger is given in section 2. The Local trigger algorithm is presented in section 3. The description, functions and interfaces of the Local trigger board are given in section 4, 5, 6, respectively. Results from test bench and radiation tests are detailed in section 7. Finally, the performances of a small area prototype of the trigger system tested with the CERN/SPS muon beam at the Gamma Irradiation Facility are reported in section 8.

References:

- [1] ALICE collaboration, ALICE Technical Proposal, CERN/LHCC 95-71 (1995).
- [2] H. Satz, Rept. Prog. Phys. 63 (2000) 1511.
- [3] R. Vogt, Phys. Rept. 310 (1999) 197.
- [4] ALICE collaboration, MUON Spectrometer Technical Proposal, CERN/LHCC 96-32 (1996).
- [5] ALICE collaboration, TDR of the MUON Spectrometer, CERN/LHCC 99-22 (1999); Addendum 1 to the TDR of the MUON Spectrometer, CERN/LHCC 2000-046 (2000).
- [6] R. Santonico and R. Cardarelli, Nucl. Instrum. Meth. 187 (1981) 377.
- R. Arnaldi et al., Nucl. Instrum. Meth. A 451 (2000) 462.

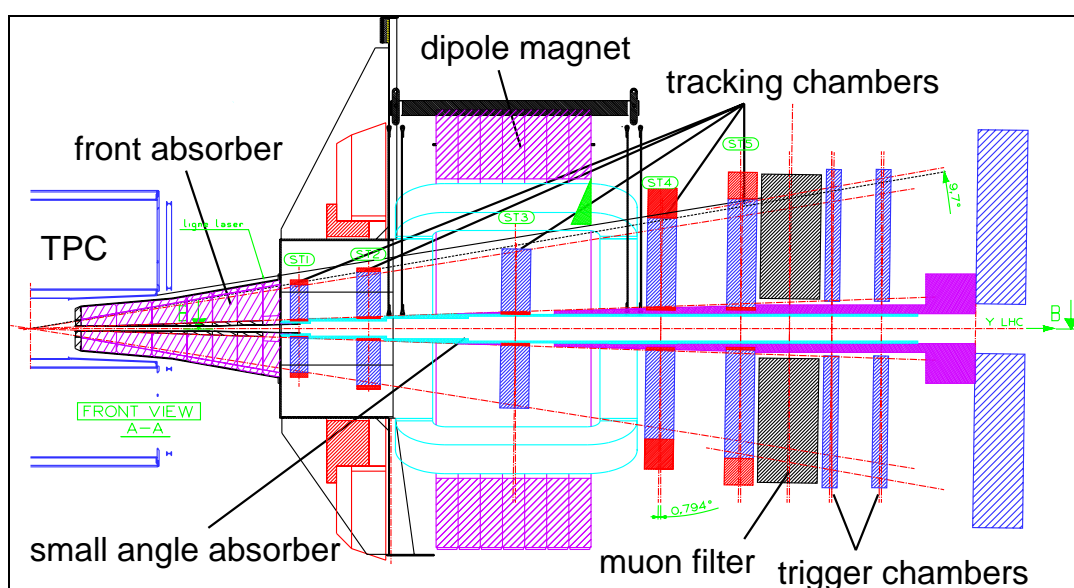

Figure 1-1: dimuon arm setup.

⁴ Central Trigger Processor.

2 DESCRIPTION OF THE DIMUON TRIGGER

Note : it is encouraged to consult the document prepared for the PRR of the FE electronics of the ALICE dimuon trigger [1] prior to read this one.

In this section, we first give a general overview of the organization of the trigger electronics. Then we describe in detail all the segmentation and numbering aspects, from the readout channels up to the trigger electronics.

2.1 ORGANIZATION OF THE TRIGGER ELECTRONICS

The trigger electronics is organized in three levels: Local, Regional and Global, as depicted in Fig. 2-1.

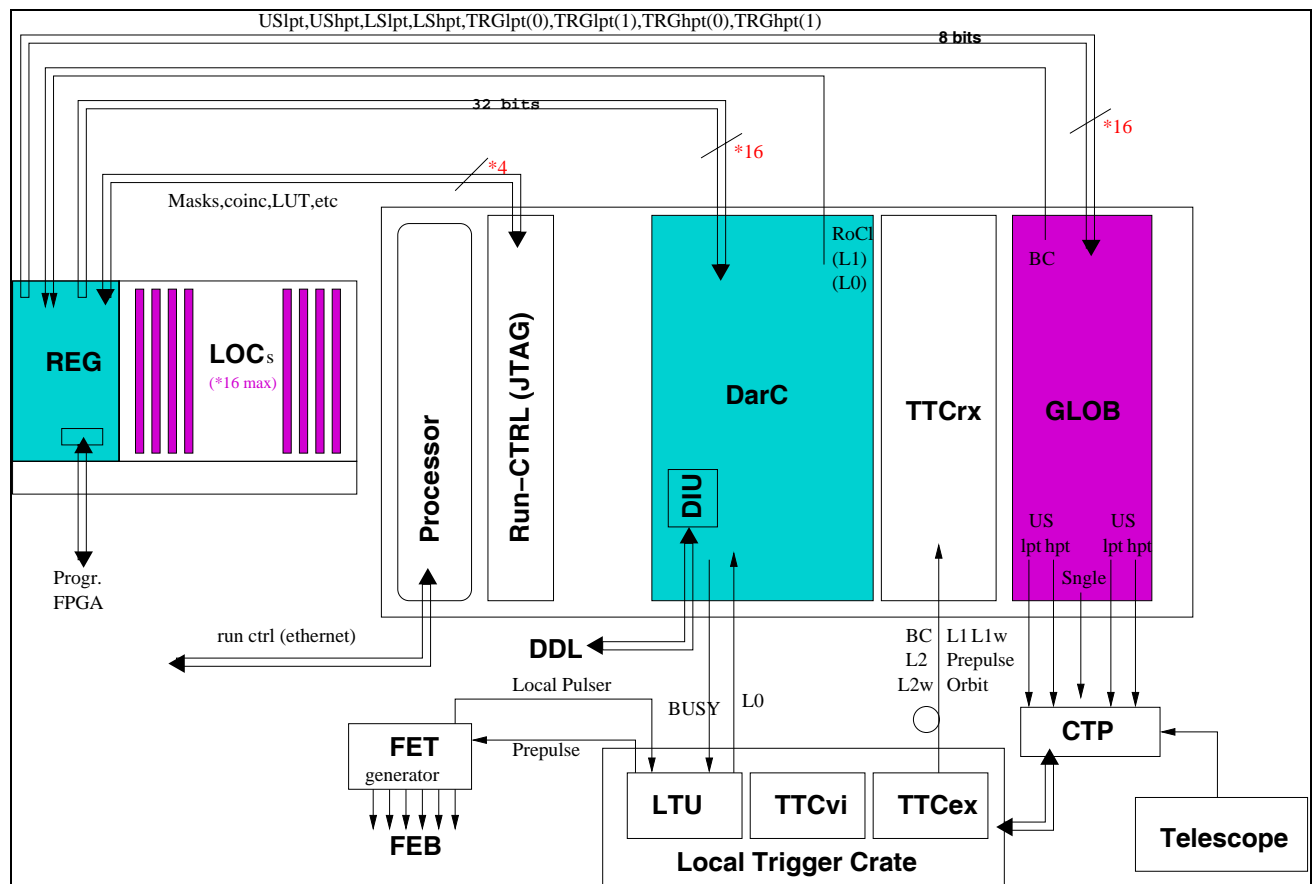

Figure 2-1: organization of the dimuon trigger electronics.

The Local electronics, housed in 16 crates, receives the signals from the FEE. The crate controllers, called Regional boards, collect the trigger decisions from the Local boards. The 16 Regional trigger decisions are finally gathered by one unique board, the Global board, which communicates the dimuon trigger decision to the ALICE Central Trigger Processor (CTP). In the Global board too, the BC clock is tuned (with a required accuracy of 1ns, in order to optimize the FEE signal latch) and broadcasted to the Local boards.

The information delivered by the FEE as well as the trigger decisions are stored in the DaQ registers of the Local boards. It is transferred in the DarC board on occurrence of a valid ALICE trigger sequence and subsequently in the ALICE DaQ system through a DDL (Detector Data Link).

The DarC board manages and transmits the necessary control signals (see §2.2) to the Local boards. The run-control parameters are communicated to the Local board by means of a JTAG link.

The total decision time, from the interaction to the output of the Global board, is presently evaluated to **660ns** (Fig. 2-2), the decision time of the Local board itself being 250ns. We recall that one requirement for participating to the ALICE L0 trigger level is to deliver the decision to the ALICE Central Trigger Processor (CTP, [2]) in less than 800ns (the CTP is located only a few meters away from the Global trigger board).

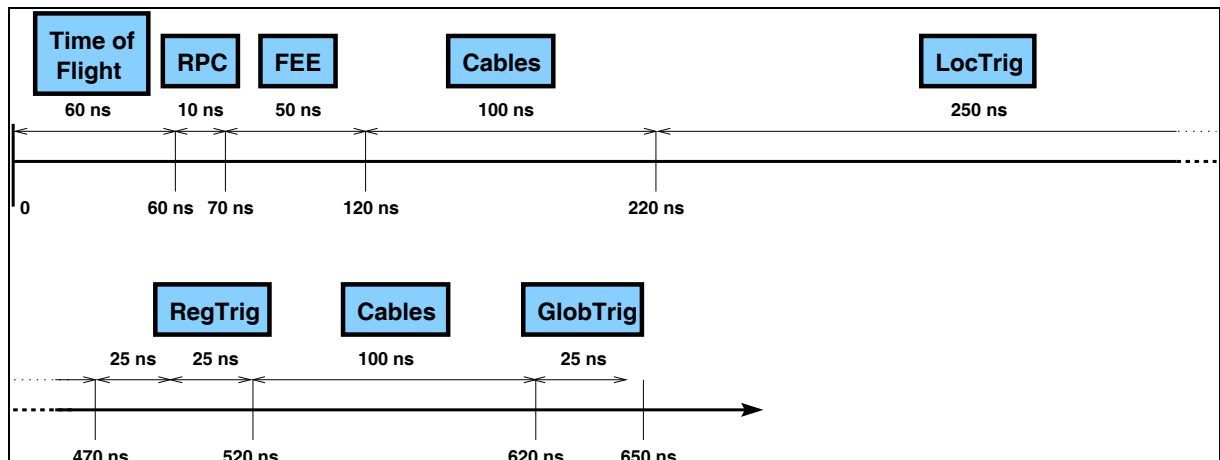

Figure 2-2: time budget of the dimuon trigger.

The total transfer time of an event (except the “scaler registers”, see §5.2) from the Local boards to the DARC board is evaluated to $8\mu\text{s}$ (fixed latency).

2.2 CONTROL SIGNALS

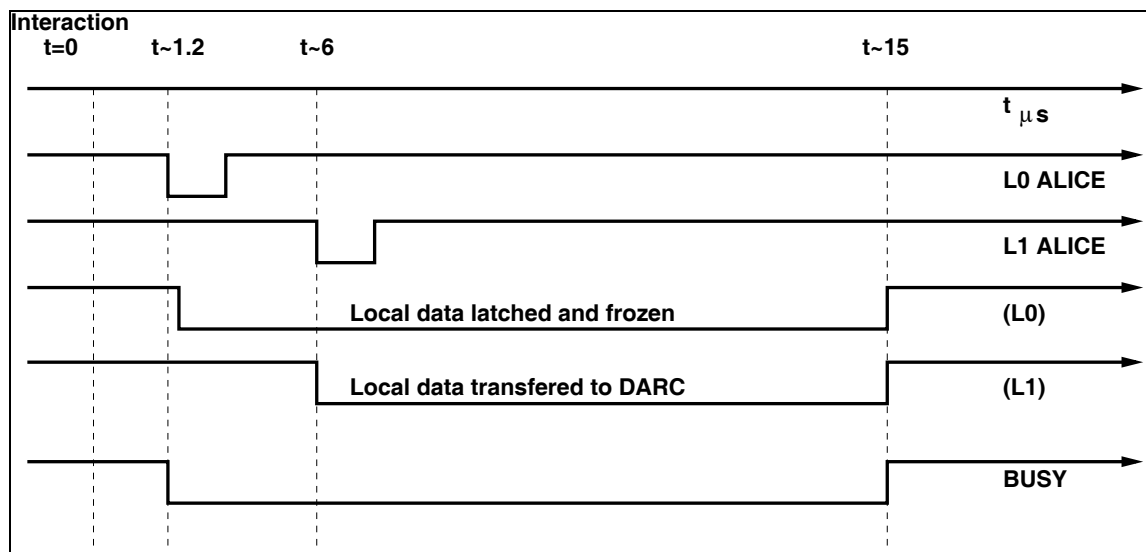

Figure 2-3: transfer sequence from the Local board to the DARC board.

The state of a few important control signals during a transfer sequence from the Local board to the DarC board is shown in Fig. 2-3. These signals are managed by the DarC board.

Any ALICE-L0 signal initiates the latch of the data contained in the Local board DaQ registers (except the “scaler registers”, see §5.2). The data are maintained in this state until the end of the transfer sequence. The transfer to the DarC board starts only after the reception of the ALICE-L1 signal and lasts a few micro-seconds (frequency of the Readout Clock RoCl = 10MHz). If the ALICE-L1 signal is not received a few micro-seconds after ALICE-L0 (time-out), the data latch is released. The BUSY is set during all the transfer sequence: no other ALICE-L0 and ALICE-L1 are accepted.

The delay between the reception of the ALICE-L0 and the start of the data latch is adjusted in the DARC board according to the length of the Local board pipeline depth (delay of a few BC clock cycles with a required accuracy of half a clock period).

2.3 READOUT STRIP SEGMENTATION

The trigger setup is organized in 2 stations, MT1 and MT2. Each station has two planes, MT11-MT12 for MT1 and MT21-MT22 for MT2.

By convention, the X strips are horizontal. They are used to measure the magnetic deflection of the charged particles by the muon arm dipole. This deflection is vertical and obviously dependent on the particle momentum.

The Y strips are vertical. They increase the robustness of the system against background.

	X STRIPS (horizontal)			Y STRIPS (vertical)	
Strip pitch (mm, for MT11)	10.625	21.25	42.50	21.25	42.50
Number of strips	3840	8448	2688	3584	2432
Total	14976			6016	
Total	20992				

Table 2-1: number of strips with different pitches of the readout planes.

The number of strips of the readout planes are given in Tab. 2-1. The strip length varies from 170 to 680mm in MT11. There are three pitch values of 10.6, 21.2 and 42.4mm. On the other trigger planes, the strip pitch and length are projective relative to the IP. The projection factors relative to MT11 are 1.011, 1.062 and 1.073, respectively for MT12, MT21 and MT22.

Maps of the readout strips, for the top right part of the trigger plane MT11, are shown in Fig. 2-4 for the X-plane and in Fig. 2-5 for the Y-plane. Consult Reference [3] for more details. Each half of the detector, Right (R) or Left (L), is divided into Lines from L1-L9, actually corresponding to the RPC detectors, and Columns from C1-C7.

X strips	14976
Y strips	6016
Total strips	20992
X cables (16 pairs)	936
Y cables (16 pairs)	496
Total cables (16 pairs)	1432
Connectors on FEE boards (8 pairs)	2624
Connectors on the cables : FEE side (8 pairs)	2864 (2624 used)
Local board side (16 pairs)	1432
Total Local boards (see details in next sections)	234
Front panel connectors on the Local boards (2×16 pairs)	936 (716 used)
Transverse connectors on the Local boards (32 pins, 2 connectors per board)	216 (male-female)

Table 2-2: number of strips, cables and connectors.

Few relevant numbers concerning the number of strips, cables from the FEE to the Local boards and connectors (on the FEE boards, on the cables and on the Local boards except those on the VME buses) are given in Tab. 2-2. The additional cables and connectors for the case of the column with 22 Local boards (see §2.4.5) are not listed because they are specific

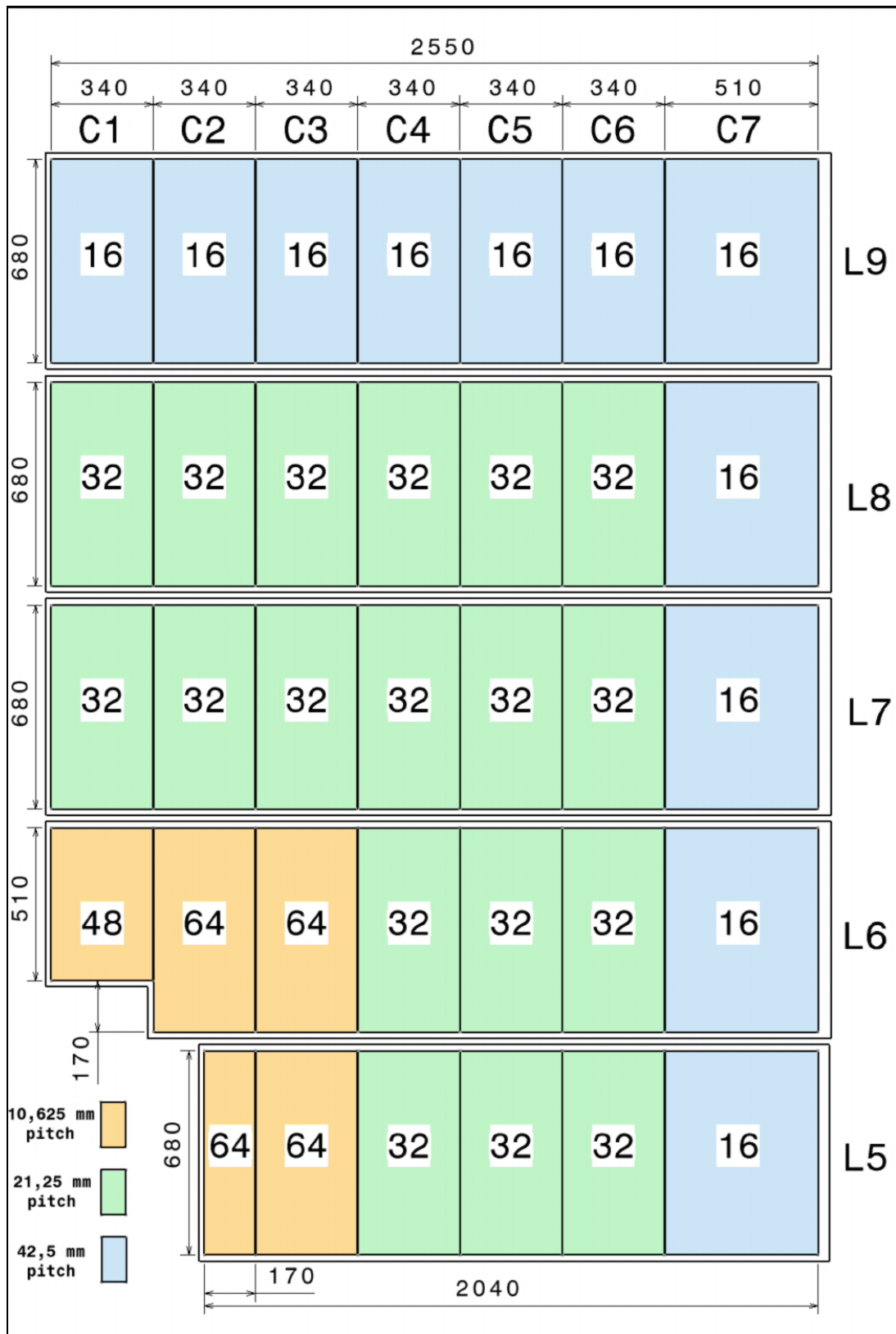

Figure 2-4: map of the X-strips, for the top right part of trigger plane MT11. The colors indicate different strip pitches. The number of strips is displayed on the figure.

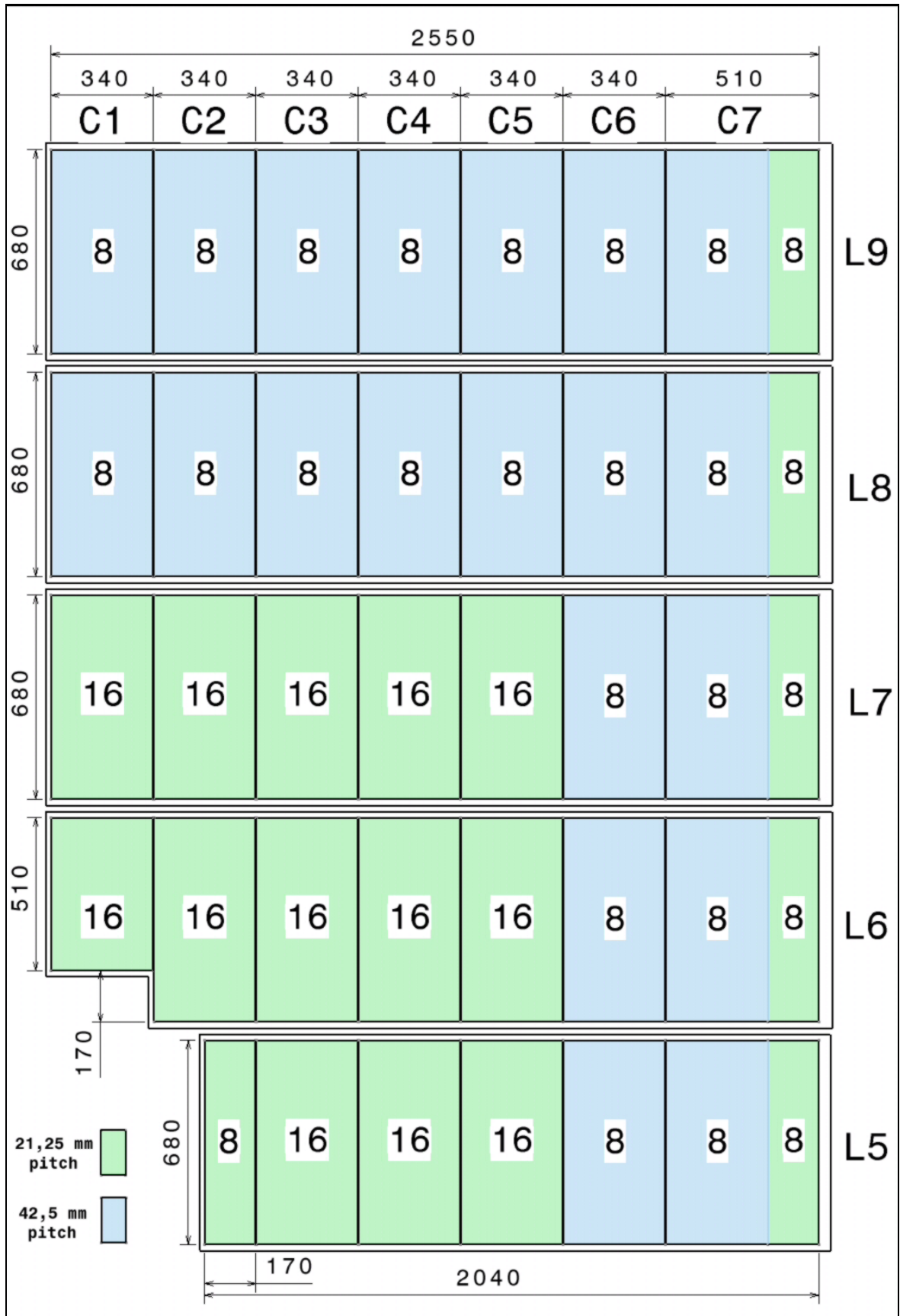

Figure 2-5: map of the Y-strips, for the top right part of trigger plane MT11. The colors indicate different strip pitches. The number of strips is displayed on the figure.

2.4 THE LOCAL BOARDS

The Local boards search for straight line tracks between MT1 and MT2 and evaluate their magnetic deflection, by executing the algorithm implemented in their FPGA⁵. For this purpose, each Local board receives the information of the four detector planes, from given areas in X and Y. These areas are strictly projective in X and Y, from plane to plane, with respect to the IP. As it is discussed in more details in what follows, the maximum measurable deflection has been fixed, for practical reasons, to ± 8 strips in the vertical direction (X strips) and ± 1 strip in the horizontal direction (Y strips). This defines the maximum width of the open "roads" between MT1 and MT2.

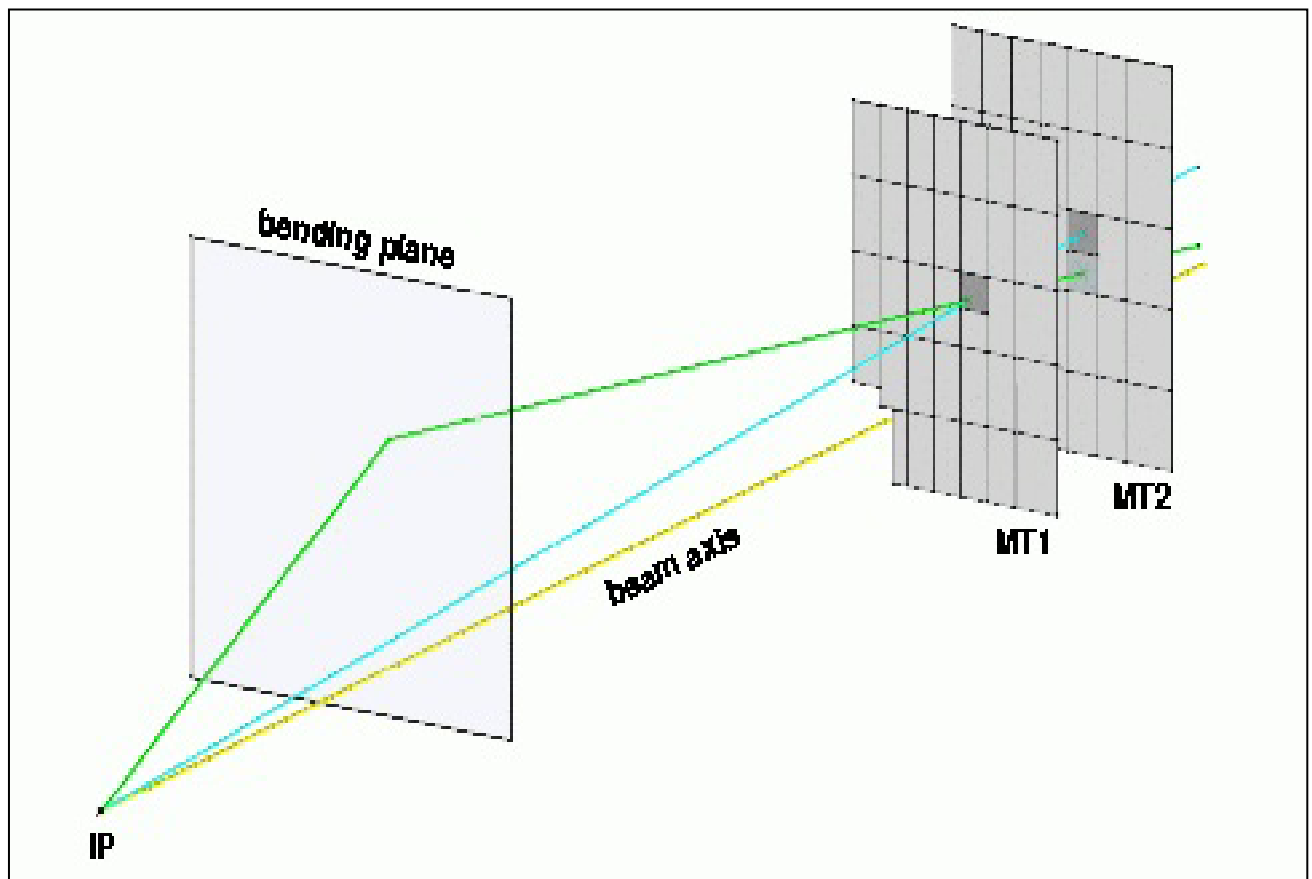

Figure 2-6: area (dark grey) corresponding to the information directly sent by the FEE to one Local board, from MT1 and MT2. This area is projective in X and Y relative to the IP. The trajectories of two particles, one with infinite momentum (blue), the other with finite momentum (green), is drawn.

It is then obvious that, due to the track deflection, the piece of projective information which is given directly from the FEE to a Local board is NOT sufficient. This is illustrated in Fig. 2-6. As a consequence:

- **any Local board of a given column must share information with it(s) neighbour(s);**
- **any column can be considered independently of any other column, as far as the Local boards are concerned, since the deviation is vertical only.**

⁵ Field Programmable Gate Array

2.4.1 NUMBERING OF THE LOCAL BOARDS

The numbering of the Local boards follows the numbering conventions of the FEE boards as well as those of the signal cables (linking the FEE to the Local boards).

At the FEE side, the numbering conventions are the following:

Example of the FEE board: **1RC1L2X7**

1	=	plane	(from 1 to 4, 1 == the closest to the I.P.)
R	=	Right	(or L=Left), as seen from the I.P.
C	=	Column	(vertical)
1	=	column number	(from 1 to 7)
L	=	Line	(corresponds also to a RPC number)
2	=	line number	(from 1 to 9)
X	=	strip X	(or Y)
7	=	FEE board octet	(from 1 to 8)

In the vertical direction, the numbering always runs from bottom to top. For example, the Line L9 is the top-most one.

In the horizontal direction, the numbering always runs from the centre to the edges of the detector. For example, the Column C1 is the inner-most column.

The Local board numbering is then:

Example of the Local board: **RC1L2B2**

R	=	Right	(or Left)
C	=	Column	
1	=	column number	(from 1 to 7)
L	=	Line	
2	=	line number	(from 1 to 9)
B	=	Board	
2	=	board number	(from 1 to 4)

A map of the Local boards is presented in Fig. 2-7.

2.4.2 NUMBER OF LOCAL BOARDS

The number of Local boards per column is given in Tab. 2-3.

Column	7L//7R	6L//6R	5L//5R	4L//4R	3L//3R	2L//2R	1L//1R	Total
Number of boards	9//9	16//16	16//16	16//16	22//22	22//22	16//16	234

Table 2-3: number of Local boards.

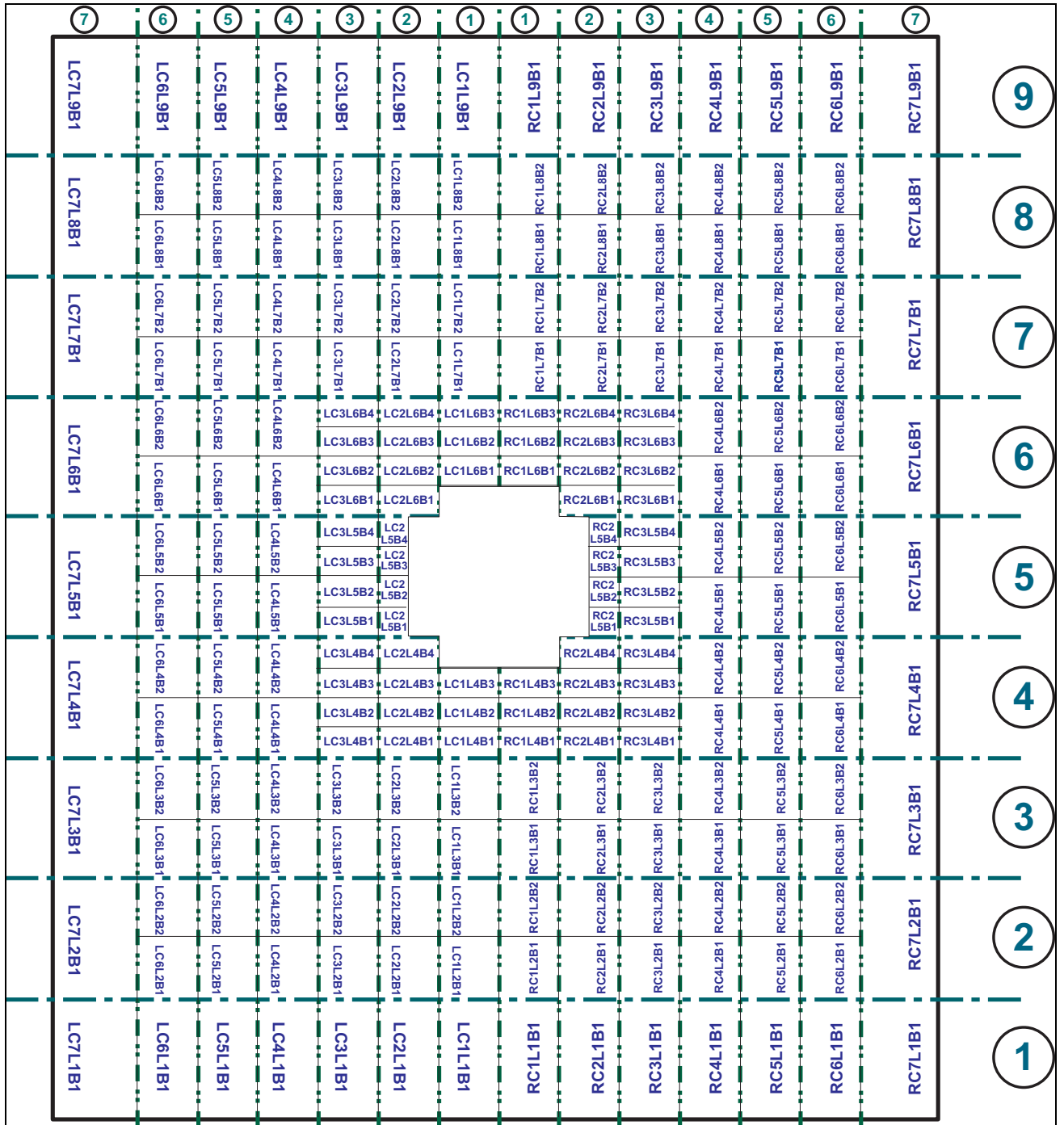

Figure 2-7: map of the Local boards (as seen from the I.P.).

2.4.3 LOCAL/REGIONAL CRATES IN THE ALICE CAVERN

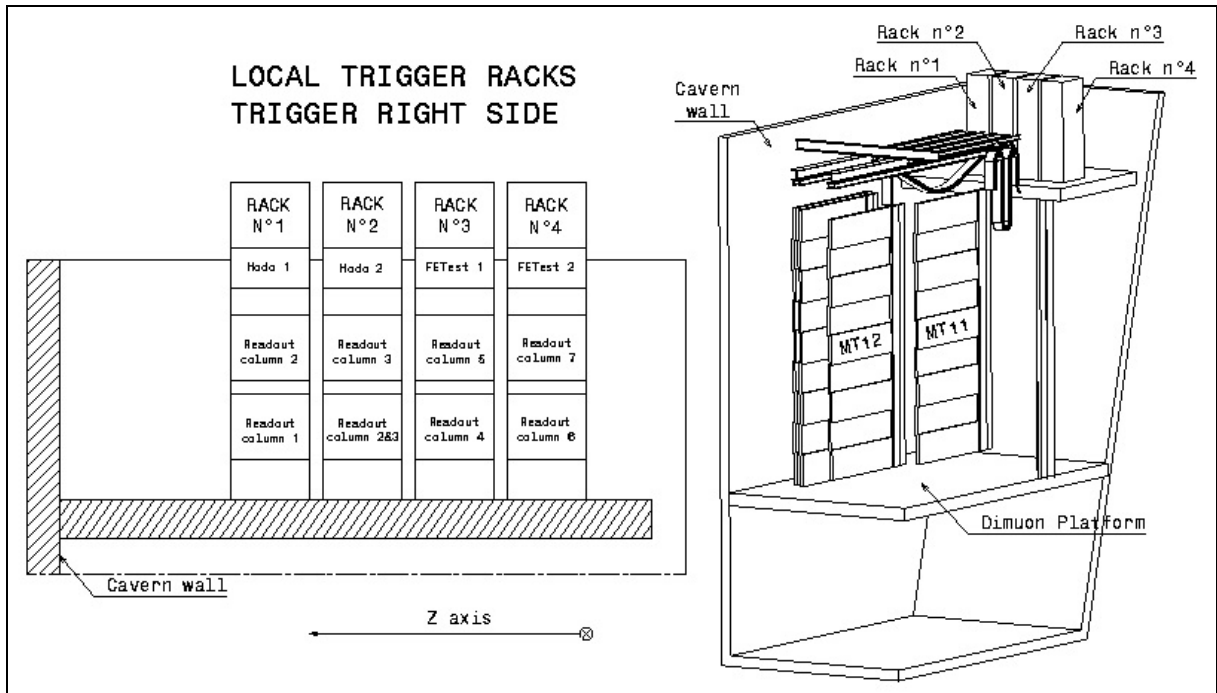

Figure 2-8: location of the Local/Regional crates and racks in the ALICE cavern.

The Local/Regional crates and racks will be located on the gangways in the ALICE cavern, as shown in Fig. 2-8. The signal cables from the FEE to the Local boards will be supported by cable “garlands”, allowing the opening of the detector. The position of the crates in the racks has been optimised for reducing the cable lengths.

2.4.4 CONFIGURATION OF THE LOCAL BOARDS

In order to simplify and optimize their cost, the Local boards are all identical. They must be however configured by means of a set of 10 switches. This configuration depends on the area of the setup corresponding to the board.

The switch values are interpreted by the corresponding programmable circuit of the Local board:

- TRIGGER X, executing the Local trigger algorithm in the bending direction;
- TRIGGER Y, executing the Local trigger algorithm in the non-bending direction;
- Mask Y, masking of the Y inputs.

The switch names, their associated programmable circuit and their function are summarized in Tab. 2-4.

SWITCH	CIRCUIT	FUNCTION	
x2d	Trigger Y	Y3d-Y4d	8 → 16 bits
x2m	Trigger Y	Y1m-Y4m	8 → 16 bits
x2u	Trigger Y	Y3u-Y4u	8 → 16 bits
OR[1:0]	Trigger Y	00 → Y3m : Y4m 01 → Y3m+Y3u : Y4m+Y4u 10 → Y3m+Y3d : Y4m+Y4d 11 → Y3m+Y3d+Y3u : Y4m+Y4d+Y4u	
ZERO-ALLY-LSB	Mask Y	Y1-Y4	8 LSB = 0
ZERO-down	Trigger X	X3d - X4d	8 MSB = 0
ZERO-middle	Trigger X	X3m - X4m	= 0 (not used)
ZERO-up	Trigger X	X3u - X4u	8 LSB = 0
EN-Y	LVDS receivers	Y1-Y4	LVDS receivers in high impedance state

Table 2-4: switch denomination, corresponding programmable circuit and function.

The u, m, d indices refer to the up, middle and down board in the same vertical column respectively.

For the Local boards receiving their Y1-Y4 inputs via the transverse connectors, the EN-Y switch allows to set the LVDS receivers (corresponding to the Y1-Y4 front connectors) in high impedance state.

A few examples of switch configurations acting on the Trigger X circuit (and algorithm) are shown in Fig. 2-9 to 2-11.

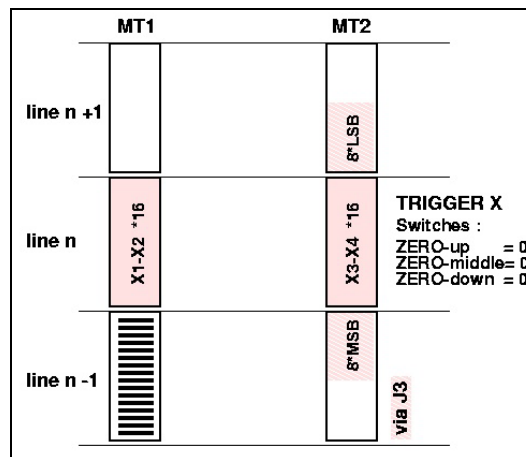

Figure 2-9: ex. of Trigger X switch set.

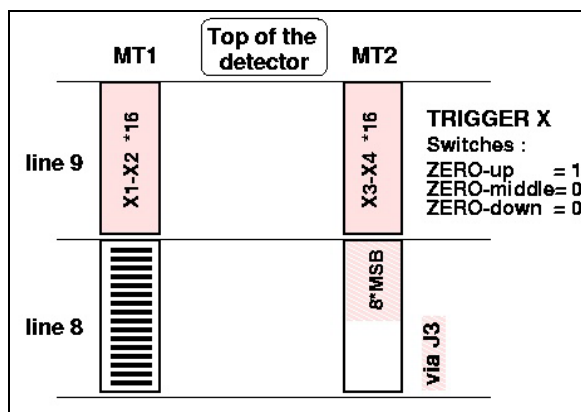

Figure 2-10: ex. of Trigger X switch set.

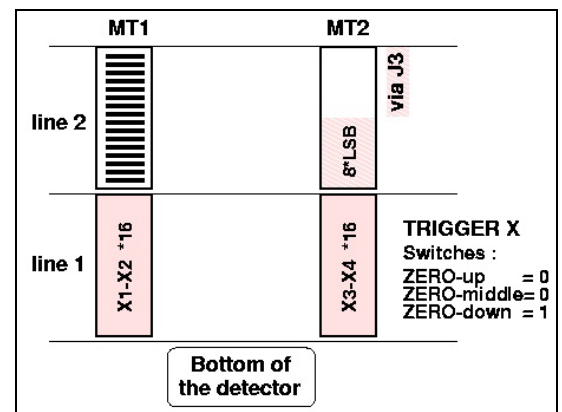

Figure 2-11: ex. of Trigger X switch set.

For example, Fig. 2-9 represents the X inputs (from MT1 and MT2) of three Local boards corresponding to three adjacent Lines of the same Column. Due to the track deflection, the board of Line n must know a part of the inputs from Lines (n-1) and (n+1) of the rear trigger station MT2, as represented by the pink zone (this information will be actually communicated via the VME J3 bus, see section 6).

The X switches, ZERO-up=ZERO-middle=ZERO-down=0 as indicated on Fig 2-9, communicate this information to the board (to the algorithm). Two other cases of X switches are shown in Fig. 2-10 and 2-11 which correspond respectively to the board Lines at the top and at the bottom of the setup. The switch ZERO-up=1 (ZERO-down=1) indicates that no information is expected from the "up" ("down") board. Such switch configuration would be also valid for the boards receiving their X inputs from the strips located just below or just above the beam shielding.

A few examples of switch configurations acting on the TRIGGER Y circuit and algorithm are shown in Fig. 2-12 to 2-16.

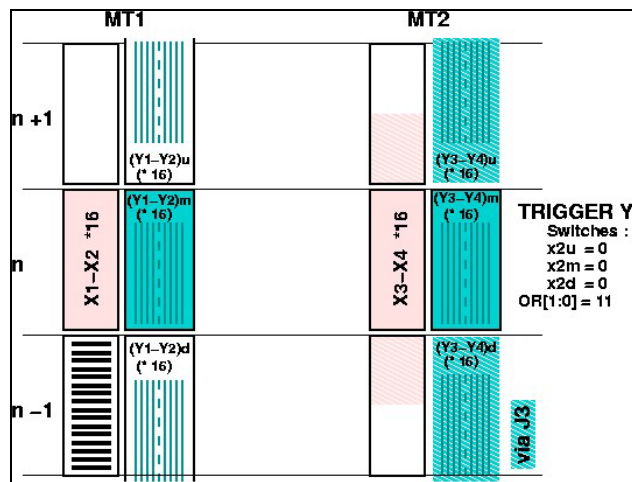

Figure 2-12: ex. of Trigger Y switch set.

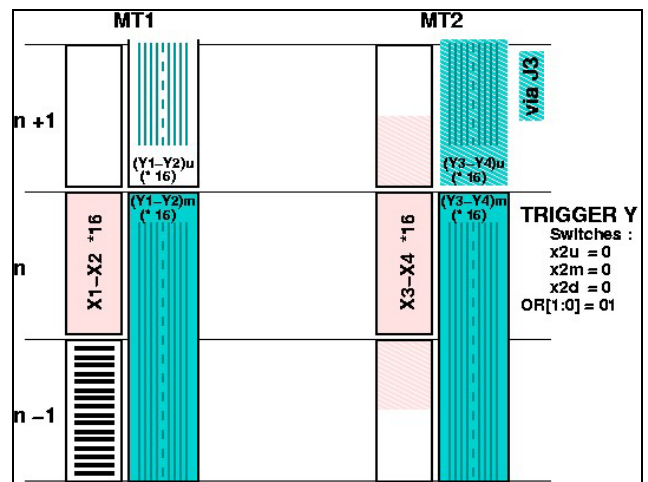

Figure 2-13: ex. of Trigger Y switch set.

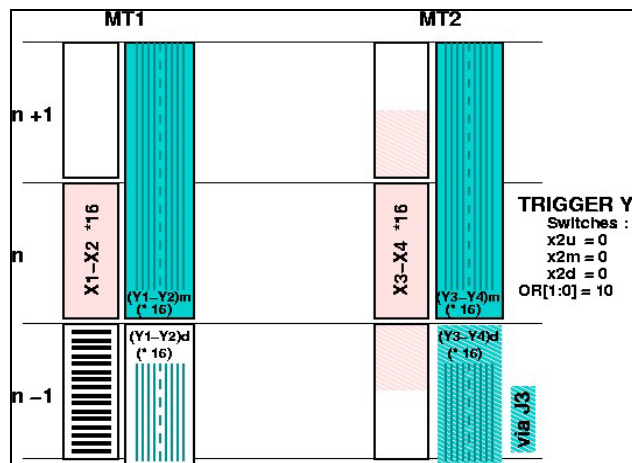

Figure 2-14: ex. of Trigger Y switch set.

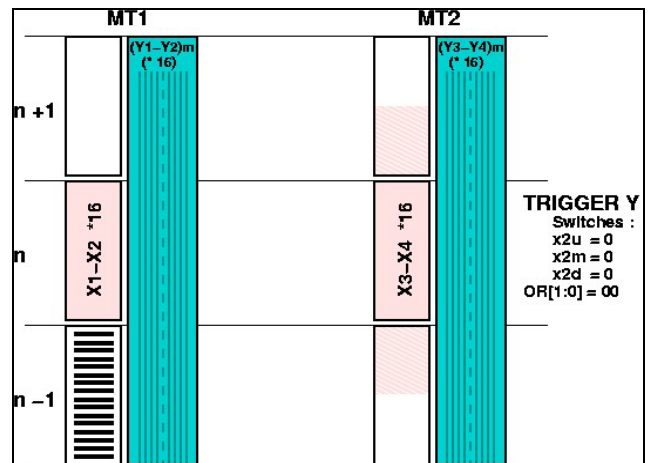

Figure 2-15: ex. of Trigger Y switch set.

In Fig. 2-12 to 2-16, the Y area on MT1 and MT2, corresponding to the circuit n, is represented in green. This area must be **at least** in overlap with the X deflection zone, in pink (on the detector, these X and Y area are of course back to back, on both side of the gas gap). Since the X and Y strip segmentation are different, there are different possible cases of overlaps as shown in the different figures. The Y switch configuration allows to account for all possible cases. Especially, as shown in Fig. 2-16, in case of a strip pitch change in a given Y circuit, the Y switch set must indicate to the algorithm how to correctly match the strips (x2u=1 in this case).

Upon cases, the Y information can be passed from board to board either via the J3 bus or via the transverse connectors. For example, in the case corresponding to Fig. 2-15, assuming that the board (n-1) receives directly the outputs from the FEE (**only one FEE output per channel is available**), the Y1-Y4 will be communicated to the boards n and (n+1) via the transverse connectors. The EN-Y switch of the boards n and (n+1) will need to be activated (EN-Y=0).

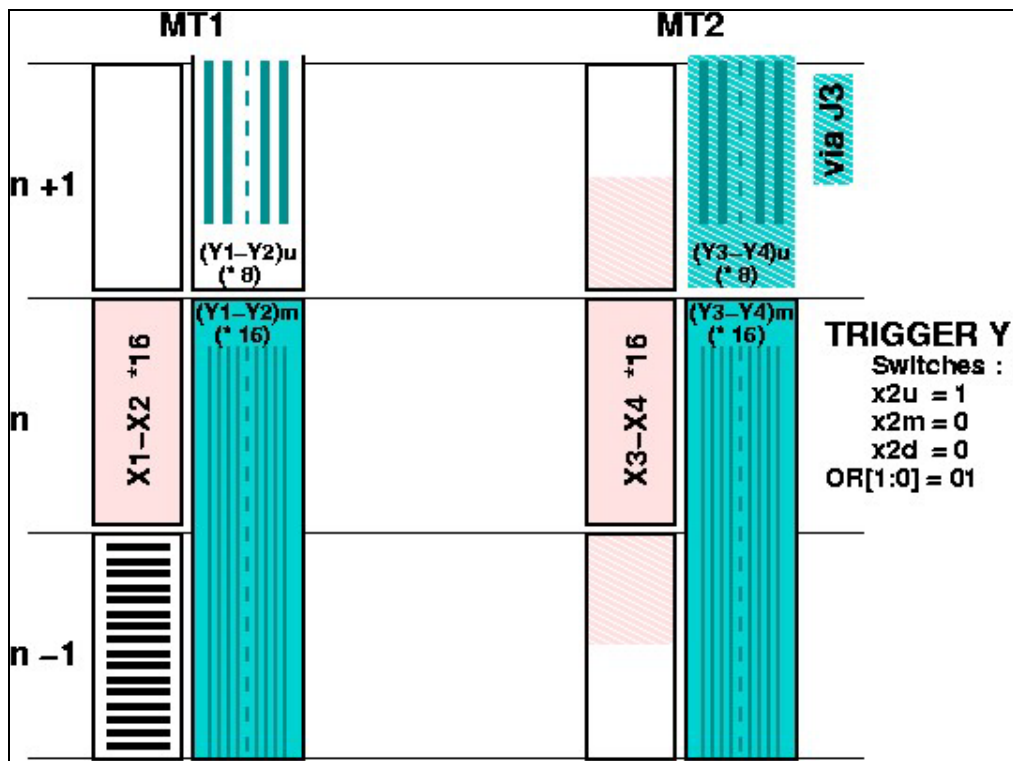

Figure 2-16: ex of Trigger Y switch set in case of two different Y strip pitches in the same Y circuit.

The particular switch configurations of the boards RC2L5B4 and RC2L6B1 are shown in Fig. 2-17 and 2-18, respectively. For RC2L5B4, the switch ZERO-ALLY-LSB must be activated to account for the particular strip configuration in this area. The action of this switch is to reset globally the 8*LSB⁶ Y bits via the Mask Y circuit.

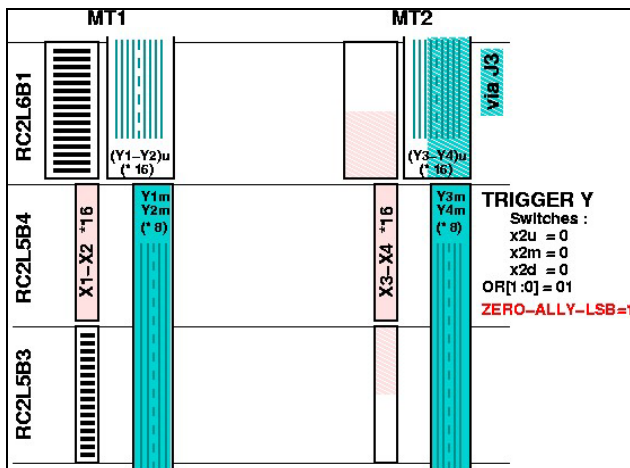

Figure 2-18: ex. of Trigger Y switch set (particular case).

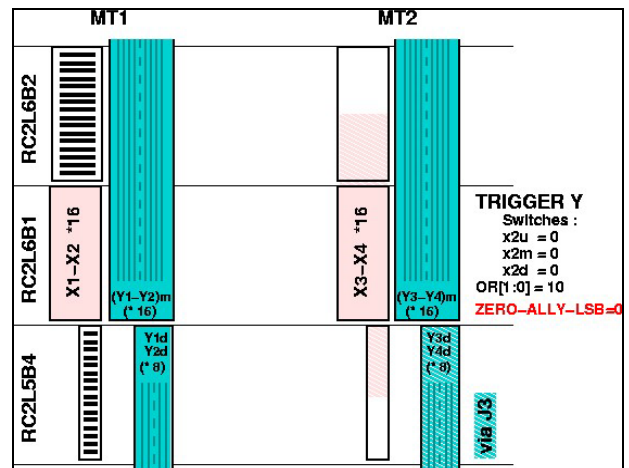

Figure 2-17: ex. of Trigger Y switch set (particular case).

⁶ Least Significant Bit.

2.4.5 PARTICULAR CASE OF THE COLUMNS WITH 22 LOCAL BOARDS

The particular case of a column with more than 16 Local boards must be considered in detail. This is the case for the columns 2 and 3 (Right and Left) which have 22 boards. Since the number of slots in a crate is limited to 16, the boards in such columns are spread out in two different crates. Obviously, the last board of one crate can not anymore communicate with the first one of the other crate via the J3 bus and/or the transverse connectors.

Our best solution is illustrated in Fig. 2-19, for the case of the column **RC2**. An "interface card" is needed, in each of the two crates. The data from the FEE must be duplicated in dedicated "split cards".

A first evaluation indicates that a total of $2 \times 4 = 8$ "interface cards" and $3 \times 4 = 12$ "split cards" (two "split cards" for the Y and one "split card" for the X information, per column with 22 Local boards) will be needed. The "split cards" could be placed in the crates of the column 7L and 7R, where 7 slots are available (see Tab. 2-3).

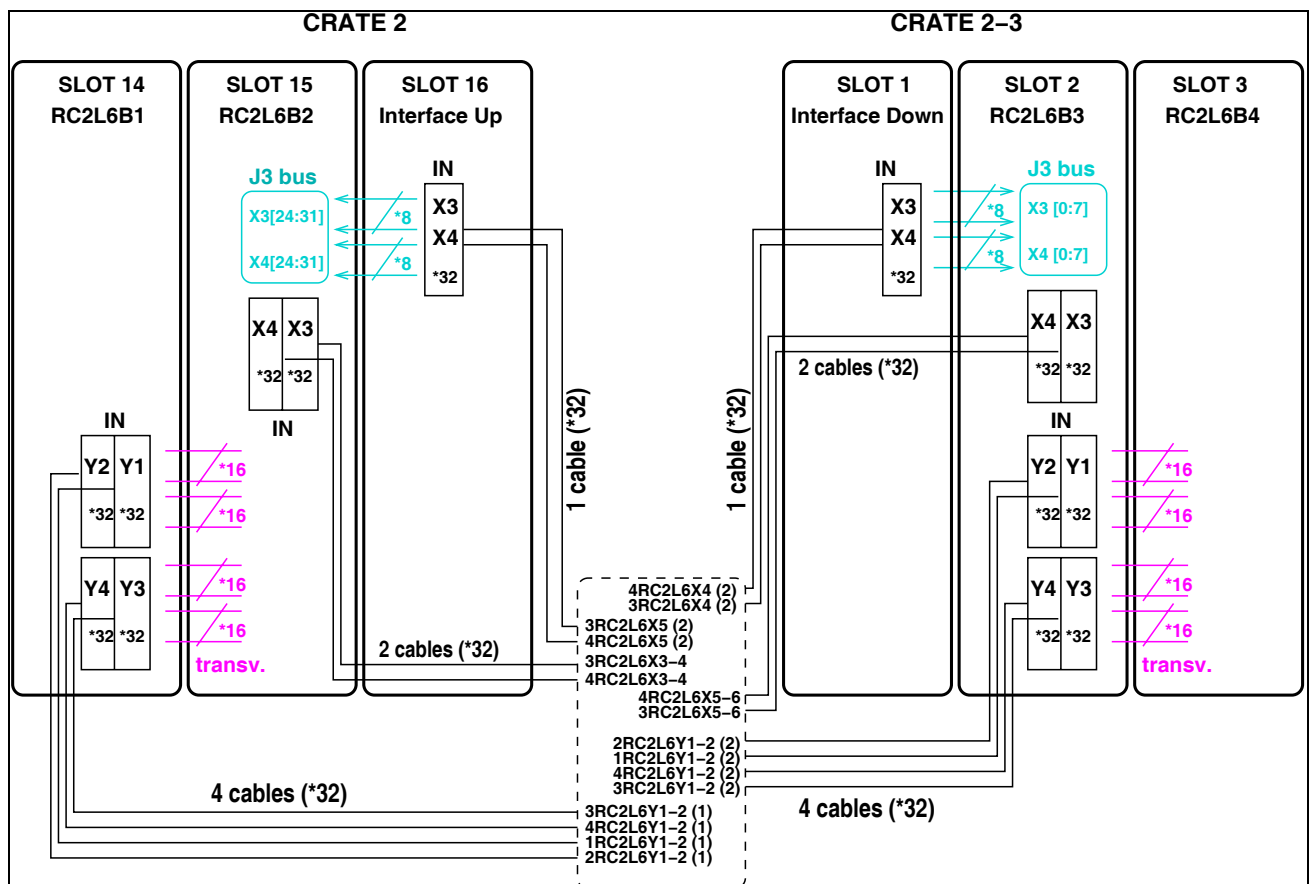

Figure 2-19: particular case for the Column RC2, with 22 Local boards (not all inputs are shown).

2.4.6 EXHAUSTIVE LIST OF THE LOCAL BOARDS

An exhaustive description of the Local trigger boards is given in Annexe 4.

The inputs from the FEE are indicated for each board, with the naming convention described in §2.4. The switch configuration is also given as well as the type (or the absence) of transverse connector.

The switch configuration given in Annexe 4 corresponds to:

x2d x2m x2u – OR[0] OR[1] – EN-Y – ZERO-ALLY-LSB – ZERO-down ZERO-middle ZERO-up

References:

[1] http://clrwww.in2p3.fr/alice_www/prr-fee.html

[2] <http://www.ep.ph.bham.ac.uk/user/pedja/alice>

[3] http://clrwww.in2p3.fr/meca/plans/Site-web/ALICE/ALICE_strips.htm

3 LOCAL TRIGGER ALGORITHM

The Local trigger algorithm, consisting in the Local logic L0-X and L0-Y, followed by the Pt cut, is described in this chapter. A general scheme is shown in Fig. 3.1 for the logic in the bending plane (L0-X) as well as in the non-bending plane (L0-Y). This algorithm has been optimized by means of simulations [1].

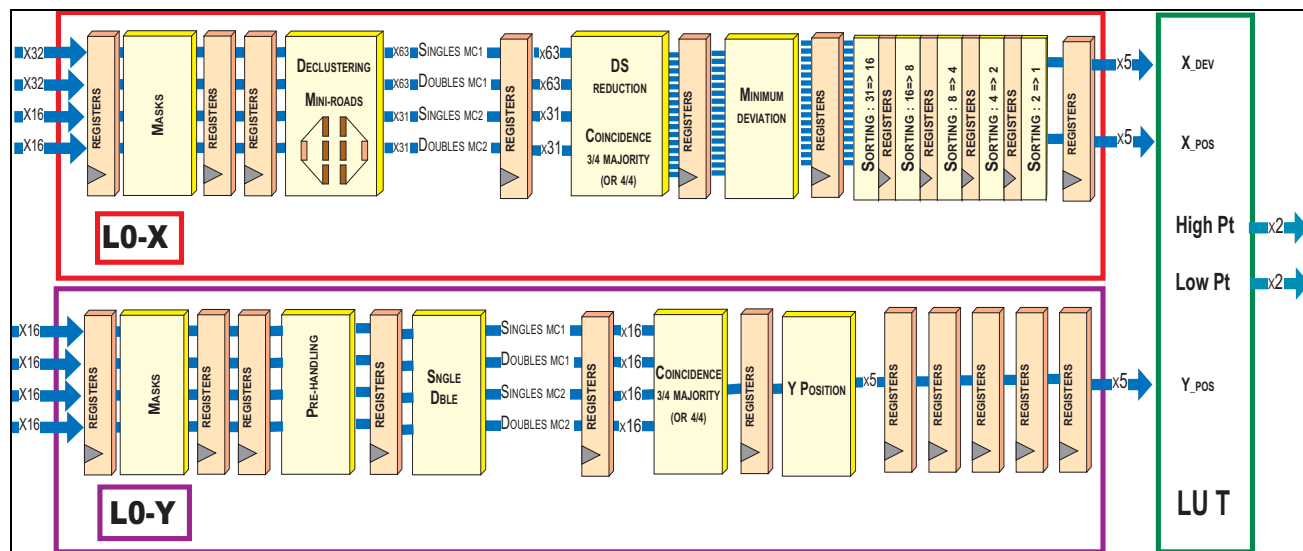

Figure 3-1: scheme of the Local trigger algorithm. The delay between two registers is 25ns.

3.1 BENDING PLANE L0-X

In the bending plane L0-X, each trigger board collects 16+16 strip information from MT1, plane 1 and 2, and 32+32 strip information from MT2 (a part coming from the J3 bus).

The information is then treated as follows:

- **Declustering:** this step aims at retrieving the most precise information on the actual track coordinates on the detection planes when at least two neighbour strips are fired. It consists in doubling the real bit-patterns by inserting a (virtual) bit between two real bits (actually corresponding to strips). The new bit-pattern is then filled according to the actual strips fired and following the procedure detailed below (see examples in Fig. 3-2). When $N=1$ or $N=2$, N denotes the number of neighbour strips fired, the centre of the cluster is selected. Indeed, experimental measurements show that a cluster with $N=2$ likely corresponds to a particle crossing the detector between two strips [1]. For $N \geq 3$, a reduction with a $(2N-5)$ algorithm is applied. This procedure is very powerful since it enhances the position resolution of the trigger. Note that the remainder of the trigger logic has to carry double length bit patterns: 31+31 for MT1 and 63+63 for MT2;

cluster size	N=1	N=2	N=3	N=4	N=5
initial cluster	0 0 1 0 0	0 0 1 1 0	0 1 1 1 0	0 1 1 1 1	1 1 1 1 1
after declustering	00001000	00000100	00001000	00001110	00111110

Figure 3-2: illustrations of the declustering for bit-patterns with a cluster size from N=1 to N=5.

- **Mini-road, Singles and Doubles:** a mini-road ± 1 strip wide (actually ± 2 bits after declustering) is opened between the two planes of the same station. This is needed to account for the particle deflection since the two planes of a station are placed 17cm away from each other. The information contained in the two planes of a station within the mini-road is analyzed. If at least one hit is found on each plane, within the mini-road, the result is called Double. In the other cases, the result is called Single. The bit-pattern of the Singles and Doubles per trigger station is then substituted for the initial bit-pattern, as sketched in Fig. 3-3.

bit pattern plane 1	000010000	000010000	000000000	010000100	100000000
bit pattern plane 2	000010000	000000000	000010000	000000111	000111000
mini-road Singles	000000000	0000 S 0000	0000 S 0000	0 S 0000000	S 00 SSS 000
mini-road Doubles	0000 D 0000	000000000	000000000	000000 D 00	000000000

Figure 3-3: examples of bit-patterns of the two planes of the same station showing the mini-road effect and the definition of Singles and Doubles.

In practice the Singles (SPL) and Doubles (DBL) are computed in one step together with the declustering and their values are as follows, see annexe 3 for details. CH1 corresponds to the bit pattern of plane 1 and CH2 corresponds to the bit pattern of plane 2, n is the position of the bit (corresponding to a "real" strip).

$$SPL[2n+1] = CH1[n] \cdot CH1[n+1] \cdot (CH1[n-1] \oplus CH1[n+2]) + CH2[n] \cdot CH2[n+1] \cdot (CH2[n-1] \oplus CH2[n+2])$$

$$SPL[2n] = CH1[n] \cdot (CH1[n-1] \oplus CH1[n+1]) + CH2[n] \cdot (CH2[n-1] \oplus CH2[n+1])$$

$$DBL[2n] = CH1[n] \cdot (CH1[n+1] \oplus CH1[n-1]) \cdot \left(\frac{CH2[n] + CH2[n-2] \cdot CH2[n-1] + CH2[n+1] \cdot CH2[n+2]}{CH2[n+1] \cdot CH2[n+2]} \right)$$

$$DBL[2n+1] = CH1[n] \cdot CH1[n+1] \cdot (CH1[n-1] \oplus CH1[n+2]) \cdot \left(\frac{CH2[n] \cdot (CH2[n-1] + CH2[n-2]) + CH2[n+1] \cdot (CH2[n] + CH2[n+2] + CH2[n+3])}{CH2[n+1] \cdot CH2[n+2]} \right)$$

- **DS reduction:** if the bit-pattern of the Doubles is non-zero, and only in this case, the bit pattern of Singles is reset. This is obviously very efficient for reducing the effect of soft-background hits on the trigger rates without compromising the signal detection efficiency. Examples of DS reduction are shown in Fig. 3-4;

mini-road Singles	000000000	0000 S 0000	0000 S 0000	0 S 0000000	S 00 SSS 000
mini-road Doubles	0000 D 0000	000000000	000000000	000000 D 00	000000000
after DS reduction	0000 D 0000	0000 S 0000	0000 S 0000	000000 D 00	S 00 SSS 000

Figure 3-4: examples of bit-patterns showing the DS reduction.

- **Road ± 8 strips with 3/4 coincidence:** for any Single or Double on MT1, a road is opened with a fixed width of ± 15 bits (i.e. ± 8 strips before declustering). A valid road requires the 3/4 coincidence condition namely S-D, D-S or D-D on MT1-MT2. Figure 3-5 shows two examples of roads. The vertical lines indicate the zero deviation, which points back to the IP. The road on the left side of Fig. 3-5 is not valid because the 3/4 condition is not fulfilled. The road on the right side of Fig. 3-5 is validated by one or the other Double of MT2;

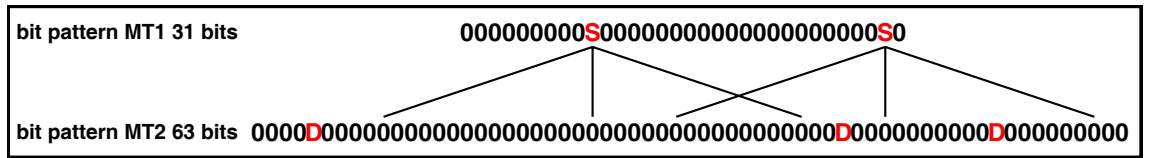

Figure 3-5: examples of Singles and Doubles defining roads from MT1 to MT2. The maximum width of the roads is indicated.

- **Minimum deviation:** the track with the minimum deviation (i.e. the higher Pt) is selected out of each valid road and among all valid roads of a circuit. The sign of the corresponding particle charge is associated to its deflection according to four possibilities: +, -, +/-, 0. The third case (+/-) corresponds to a zero-deviation. The fourth case (0) corresponds to a non-valid road. The MT1 X position of the valid road (X_pos, from 0 to 30) and the minimum deviation (X_dev, from -15 to +15) are coded in two words of 5 bits each: X_pos[4:0] and X_dev(Sign_dev[0]-dev[3:0]).

3.2 NON-BENDING PLANE L0-Y

In the non bending plane L0-Y, each trigger board collects 8 or 16 strip information from each plane. The processing steps are the following:

- **Doubling the 8 strip bit-patterns:** because of the chosen segmentation, a trigger circuit receives, in the non-bending plane, the information from either 8 strips or 16 strips. The 8 strip bit-patterns are transformed into 16 strip bit-patterns as illustrated in Fig. 3-6;

before doubling	0 0 0 0 0 1 0 0	0 1 1 0 1 0 1 1
after doubling	0 0 0 0 0 0 0 0 0 1 1 0 0 0 0	0 0 1 1 1 1 0 0 1 1 0 0 1 1 1 1

Figure 3-6: examples showing the doubling of the Y bit-patterns, from 8 to 16 bits.

- **Singles and Doubles:** as for L0-X;
- **DS reduction:** as for L0-X;
- **Road ± 1 strip with 3/4 coincidence:** this road is introduced to account for any possible deviation coming, for example, from multiple scattering, magnetic field in the non-bending plane or mis-alignment of the strips. The 3/4 coincidence condition is similar to that applied in the bending plane;
- **Select road:** if more than one valid road is found within a circuit, the chosen valid road is the one with the less significant bit on MT1. On output the MT1 Y position (Y_pos from 0 to 15) of the valid road is coded. An additional bit, Y_trig, indicates whether or not a valid Y road exists. The response of the L0-Y algorithm is finally coded in a 5 bits word: Y_trig-Y_pos[3:0].

Note that, in contrast to the L0-X part of the algorithm, the **mini-road and declustering** steps are not applied in the non-bending plane. It was indeed demonstrated [1] that these steps are not required here.

3.3 COINCIDENCE WITH 4/4 MAJORITY

The case of the 4/4 coincidence majority is also implemented in the algorithm and can be activated by means of a VME control signal (see section 5). As for the 3/4 majority, it acts on both L0-X and L0-Y.

3.4 OUTPUT OF THE LOCAL LOGIC

The output of the Local logic is finally a 15 bit word.

All possible outputs of the Local logic are summarized in Tab. 3-1. and 3-2.

L0-X	X_dev[4:0]		X_pos [4:0]
	Sign_dev	dev	
Trigger μ^-	0	1-15	0-30
Trigger μ^+	1	1-15	0-30
Trigger $\mu^+/-$ (zero-deviation)	0	0	0-30
No trigger	1	0	0

Table 3-1: output of the Local logic L0-X for all cases.

L0-Y	Y_trig	Y_pos [3:0]
Trigger	0	0-15
No trigger	1	15

Table 3-2: output of the Local logic L0-Y for all cases.

The response of the Local logic to the particular case with ALL bits of the input bit-pattern in the state "0" is: Y_trig=1, Y_pos=15, Sign_dev=1, dev=0, X_pos=0.

The response of the Local logic to the particular case with ALL bits of the input bit-pattern in the state "1" is: Y_trig=0, Y_pos=0, Sign_dev=0, dev=0, X_pos=2 (declustering).

3.5 PT CUT

As a consequence of the road maximum width (± 15 bits), the Local logic described previously selects tracks with a loose cut on the corresponding transverse momentum. The next step of the Local trigger algorithm consists in a more precise estimation of Pt. It is performed via Look-Up-Tables (LUT) which are static random access memories (SRAM).

The principle of this Pt estimation is based on the fact that each triplet (Y_pos, X_dev, X_pos) corresponds to a value of the transverse momentum. The LUT is filled according to the results of full GEANT simulations of muon tracks. The simulation includes, in particular, a realistic description of all detectors as well as their segmentation and the field map of the dipole.

Two different thresholds are considered in order to select muons coming from the decay of the J/ψ or the Υ resonance families. The corresponding cut values are roughly Pt=1GeV/c (low threshold) for the J/ψ and Pt=2GeV/c (high threshold) for the Υ .

The LUT is addressed with the (Y_trig-Y_pos[3:0]-X_dev[4:0]-X_pos[4:0]) word delivered by the Local logic. On output, the pre-loaded values for the two different thresholds (2 bits per threshold, which constitute the Local trigger decision, see below), are delivered. The LUT has a size of 128kbits:

- 2^{15} bits (32kbits) for all possible combinations of bits delivered by the Local logic;
- 2 bits for the low and 2 bits for the high Pt Local trigger. This information is used by the Regional logic. The four possible outputs, for each threshold, are by convention:
 - 00 = no trigger;

- 01 = trigger for negatively charged particles;
- 10 = trigger for positively charged particles;
- 11 = trigger with no deviation.

The loading of the LUT is performed via the VME bus. This loading takes only a few seconds. The contents of the LUT can therefore be easily updated depending on the running conditions.

Note that the LUT can be preloaded with “realistic” values corresponding to Pt cuts as discussed previously, but it is of course possible to make any other choice, like for example:

- no cut at all. Any address returns a valid trigger, 01, 10 or 11;
- a valid Y_trig may NOT be requested;
- etc.

References:

- [1] Olivier Roig, PhD thesis, Univ. Blaise Pascal Clermont-Fd (1999).
- [2] R. Arnaldi et al. for the ALICE collaboration, Nucl. Instrum.Meth. A 490 (2002) 51.

4 LOCAL TRIGGER BOARD DESCRIPTION

In this chapter, we describe the Local trigger board with its electronic circuits. We justify the technological choices and we dwell upon this board genesis.

4.1 THE “HISTORY”

At the very beginning, when we started the ALICE dimuon trigger project, some R&D had already been conducted in ATLAS on a similar topic [1]. Hence, we based our first works on the trigger algorithm of the ATLAS muon spectrometer.

Early in the development of the ALICE dimuon trigger, we pointed out some important differences between our needs and the ATLAS ones:

- missing functions needed for ALICE in the ATLAS circuit;
- number of channels, 1 million (ATLAS) vs. 22000 (ALICE):
 - no need for an ASIC: frozen design and multiple runs to achieve our goals;
 - choice of FPGA: reprogrammability.

Therefore we chose the FPGA technology to implement our own trigger algorithm. In 1998 our first prototype was born, in VME 6U size.

At this early stage the Local trigger board was meant to be coupled with a higher trigger level. It worked out the X and Y coordinates of a track, sent to a L2 trigger designed to compute the mass of a dimuon [2]. This first prototype, shown in Pict. 4-1, was built with two FPGA, one dedicated to the computation of the L0-X algorithm, the other for L0-Y (on the other side of the board). The tests were conclusive.

A year later, the Dimuon Forward Spectrometer Technical Design Report [3] was issued. Some improvements were made in the trigger algorithm with a bunch of new functions to come with (see section 2 and 5):

- more inputs and outputs per board (in order to reduce the number of boards);
- masked input option;
- Declustering algorithm;
- DaQ interface onboard;
- “Look-Up-Table” (LUT) to perform Pt cuts;
- Mini-road and DS reduction.

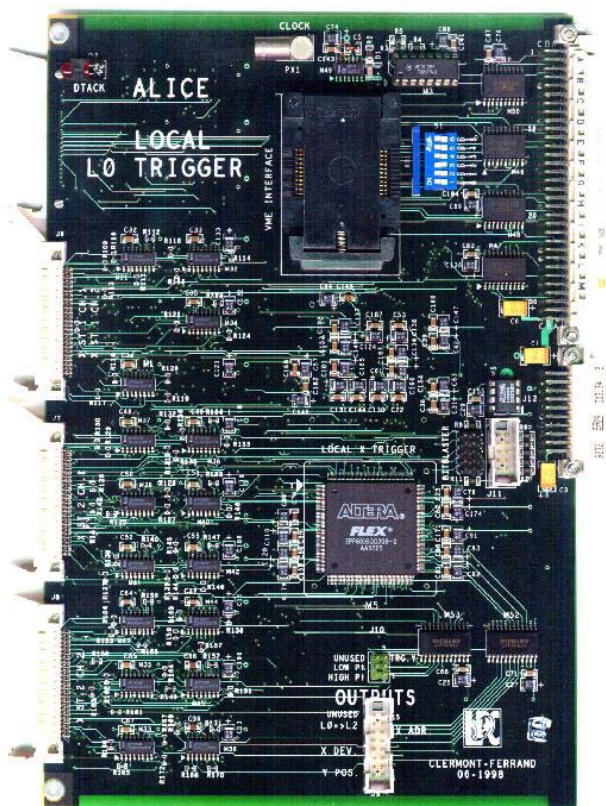

Picture 4-1: first prototype of the Local trigger board.

It has been shown that the L2 trigger system of the dimuon spectrometer was not needed anymore with the addition of the LUT at L0 level.

Hence, the prototype number 2 was much more complex: it hosted five FPGA on a VME 9U board with more than 320 I/O. The 3rd prototype is very similar to the 2nd one. We only describe this last one in what follows.

4.2 THE PRESENT LOCAL TRIGGER BOARD

4.2.1 SYNOPTIC SCHEME AND PICTURE

The synoptic scheme and the picture of the Local trigger board can be seen in Fig. 4-1 and Pict. 4-6.

4.2.2 CONNECTORS

Refer to Pict. 4-6 for all frame colours.



Picture 4-2:
front panel
connector.

As it can be seen from Pict. 4-6, the choice of a 9U board is made obvious, due to the great amount of I/O.

The four front panel connectors (outlined in red) are stacked ones (Pict. 4-2).

This 3M connector (ref. **3431-L302**) contains 2x34 contacts, 64 used for the reception of the differential signals coming from the FEE and 4 for the grounding. Two of these connectors receive the information from the X strips, the other two from the Y strips. It is 62.6mm high and 16.76mm thick. Its standard pitch (2.54mm) allows us to use standard cables (AWG28), which will ease their mounting compared to smaller ones.

In some cases, information from the Y strips is needed by up to four Local trigger boards (see section 2). As the FEE provides only one copy of each strip signal, we have to make copies of these data. We use board to board transverse connectors (outlined in green) picking the signals after the LVDS receivers (§4.2.4.1), with the following system (Pict. 4-3 to 4-5):

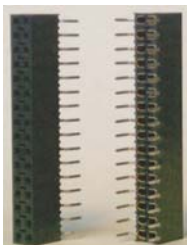

Picture 4-5: through
hole female on top of
the board.

+



Picture 4-4: surface
mounted male below
the board.

=

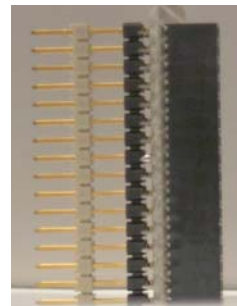

Picture 4-3:
two connectors
soldered together.

Each pin of the female connector (ref. **BCS-116-L-D-PE**) is soldered onboard with its matching pin of the male connector (ref. **HW-16-09-G-D-447-SM**). The Y data are propagated from one board to its neighbour, assuming that the outputs of the corresponding LVDS receiver are in a high impedance state. These connectors are both manufactured by SAMTEC. Note that the boards linked by these transverse connectors (four at maximum) must be plugged and unplugged simultaneously in the VME crate. It is foreseen to equip the final boards with extractors to facilitate the unplugging operations.

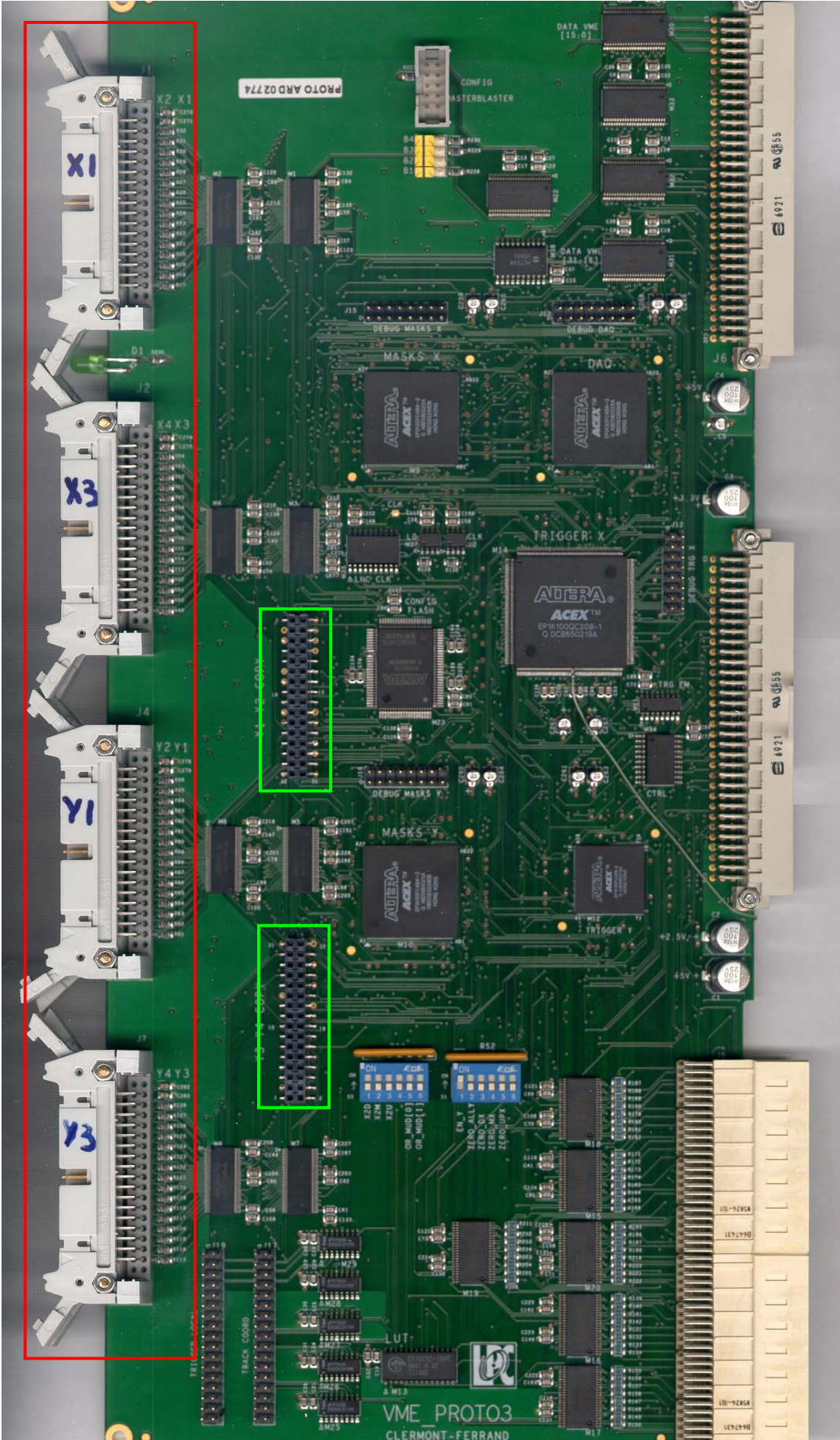

Picture 4-6: Local trigger board third prototype.

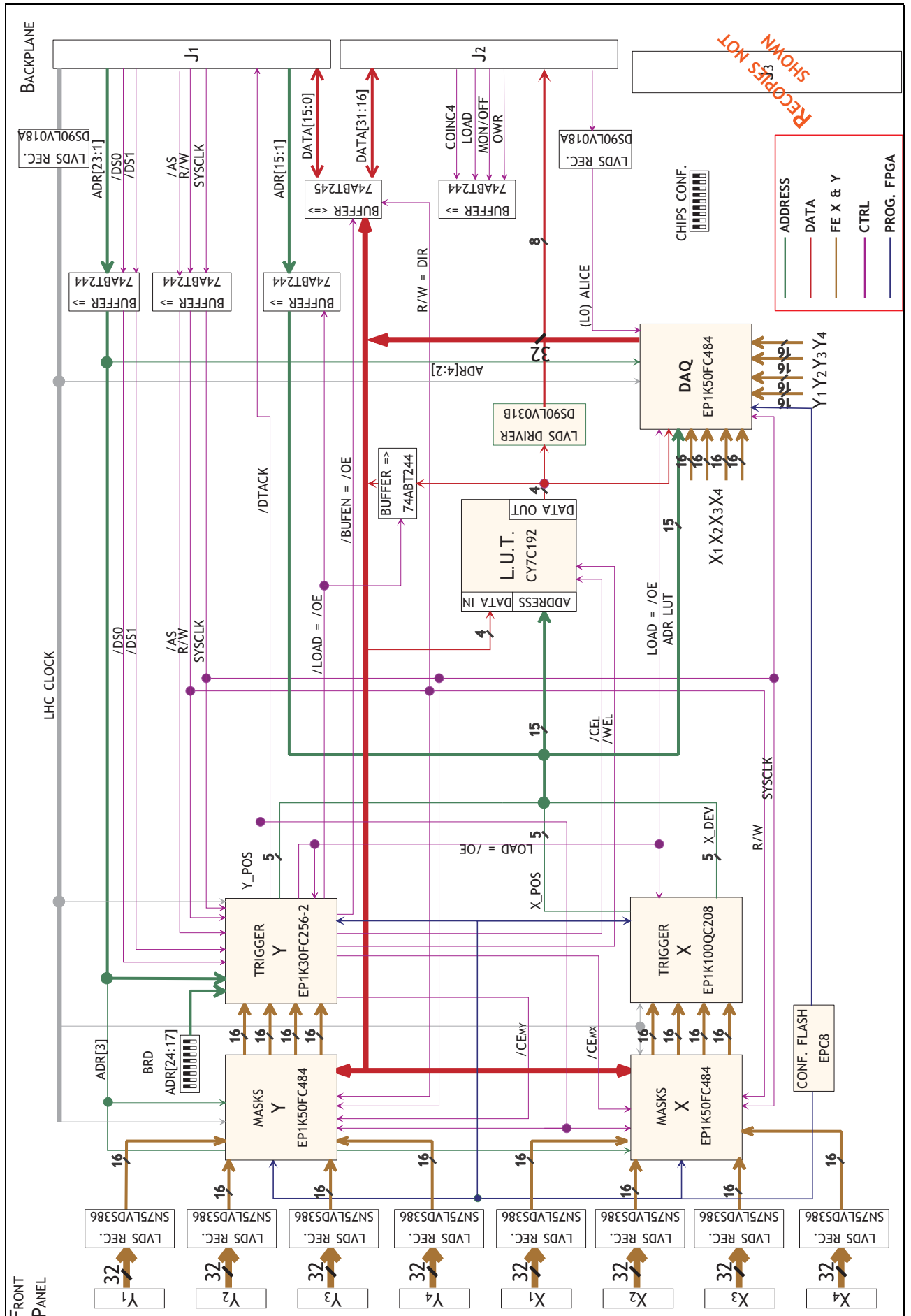

Figure 4-1: synoptic scheme of the Local trigger board.



Picture 4-9:
VME buses connectors.

On the right side of the Local board there are the same two connectors (Pict. 4-9). The top one is dedicated to the VME J1 bus, the other to the VME J2 bus. They contain 3x32 contacts and they carry all the signals from and to the Regional board: addresses, data, control, clock, triggers, etc. They are built by HARTING and their part number is **9031966921**.

On the bottom right edge there are two connectors (4x24 contacts, ref. **85824-101**) from the Framatome Metral[®] family (Pict. 4-7). They are soldered side by side in order to emulate a sole male connector with 4x48 contacts (which does not exist) to be plugged in a corresponding female connector. Each one is 47.95mm long and 10.05mm wide over the board. They are used to pass copies of X and Y signals from board to board through a dedicated J3 bus.



Picture 4-7:
MasterBlaster Connector.

To program all FPGA and their associated Flash Memory onboard, we plug a device called MasterBlaster (mfg. by ALTERA) in a 10 contact connector as shown in Pict. 4.8: we can then initialize all circuits via a JTAG bus propagated from one chip to another. In the other position, the yellow switches disconnect the JTAG bus from the MasterBlaster. The JTAG bus is then dispatched to the VME J1 bus and directed to the Regional board. On the Regional board a similar connector exists where we can connect a MasterBlaster and then program, via a JTAG chain, the Flash Memory (or the FPGA) of all Local trigger boards plugged in the VME crate.



Picture 4-8:
J3 bus connectors.

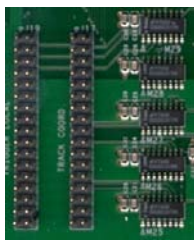

Picture 4-10:
test connectors and differential drivers.

At last, on the left bottom edge of the Local board, the Local trigger information (X_pos, Y_pos, X_dev, Local trigger decision) is available on two connectors (Pict. 4-10), in a TTL differential format. It is meant for tests purposes (see section 7 for the test bench description).

Several other connectors are spread on the board near the FPGA. They are used for debugging purposes only, as we can assign them any internal signals from their respective FPGA.

4.2.3 PROGRAMMABLE CIRCUITS

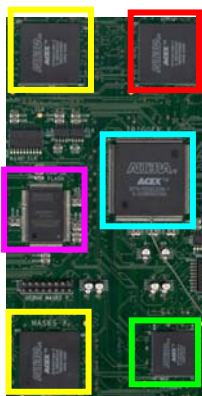

Picture 4-11:
Programmable circuits.

After reception, data are sent to the Mask circuits (outlined in yellow in Pict. 4-11), one for the X coordinates, the other for the Y. These are FPGA from the ALTERA Acex family (ref. **EP1K50FC484-2**) with 484 pins on a BGA package.

The optionally masked inputs are then received by two other FPGA of the same family, one executing the L0-X algorithm (outlined in blue, ref. **EP1K100QC208-1**), the other computing the L0-Y (outlined in green, BGA package, ref. **EP1K30FC256-2**).

The last of the programmable circuit is also from the Acex family (outlined in red, ref. **EP1K50FC484-2**); it produces all the needed signals to interface the board with the VME and holds the data to be stored by the ALICE DaQ (see section 5).

Each time a Local board is powered on, these five FPGA are programmed by a Flash Memory (outlined in purple, ref. **EPC8QC100**). This memory can be reprogrammed infinitely onboard, with the MasterBlaster device (already mentioned in §4.2.2). It takes about 45 minutes to fill up the Flash memory of one Local board.

4.2.4 MISCELLANEOUS DEVICES

4.2.4.1 LVDS receivers

The signals coming from the FEE are in LVDS standard. The Local board decodes these 128 differential information with 8 LVDS receivers (Pict. 4-12 and 4-13) from Texas Instruments (ref. **SN75LVDS386**). Each receiver deals with 16 data signals, corresponding to X or Y information from one of the four RPC planes. They provide a 100ps skew output to output and a 1ns skew maximum part to part, as well as a typical propagation time of 2.6ns. They are located close to the front panel connectors.

Picture 4-12:
X1 X2 X3 X4
receivers.

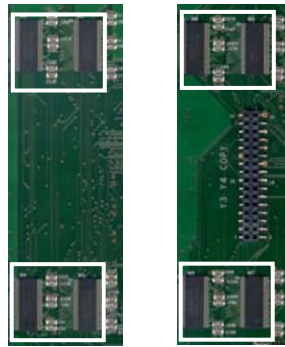

Picture 4-13:
Y1 Y2 Y3 Y4
receivers.

4.2.4.2 Other differential devices

For tests purposes we use **DS26C31TM**, see Pict. 4-10, from National Semiconductor, which are 4 channel differential line drivers.

Also from National Semiconductor we use two single LVDS line receivers, **DS90LV018ATM**, to handle the 40MHz LHC clock and of the (L0) ALICE Trigger (see §2.2). They provide a maximum part to part skew of 1ns.

The last chip is a **DS90LV031ATM** (National Semiconductor), a quad LVDS line driver which sends the Local trigger decision to the Regional board.

4.2.4.3 VME data

To interface the board with the VME data bus and address bus we have put some buffers (Pict. 4-14) located near the J1 connector.



Picture 4-14:
VME buffers.

4.2.4.4 J3 Backplane

As explained in §2.4 in the document, a Local board may need to know the X and/or Y inputs from its neighbours. That is why we developed a specific backplane (VME J3, see §6.1.3), where these data are transmitted. The Local board is plugged in this backplane thanks to high density connectors (see §4.2.2), and the data are sent through buffers (Texas Instruments, ref. **LVTH16244A**) with source terminators (Pict. 4-15).

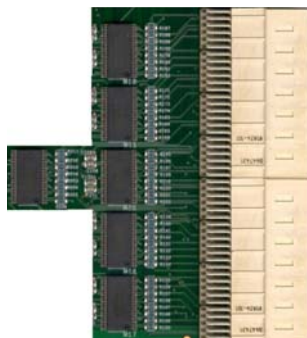

**Picture 4-15:
line drivers of
X and Y copies.**

On the RPC a maximum rate of 10000 hits/strip/s is expected, that is the reason why we have chosen source terminators (not end terminators) because at low-pulse repetition rate, they dissipate little power. Furthermore most TTL or CMOS logic gates can not source enough current to drive end terminators, especially with small line impedance, as found on printed circuit.

4.2.4.5 Look-Up-Table

The Look-Up-Table (LUT) is an important circuit for the Local trigger decision. It is filled up according to the Pt calculated from X_{pos} , Y_{pos} and X_{dev} (§3.5). We use a Cypress (ref. **CY7C192-12VC**) asynchronous SRAM with separate I/O, organized in 64kbits x 4 memory banks, with a maximum access time of 12ns.

4.2.4.6 Switches

As already explained in §2.4.4, the use of backplane or transverse copies lead us to implement onboard configuration switches. Thanks to these switches, only one type of board will be produced, each of them having its own configuration. Two 6 channels switches are put onboard to fix the configuration.

4.2.5 PRINTED CIRCUIT

The printed circuit is an 8 layer board with one ground plane, two low-voltage planes (2.5V and 3.3V) and five remaining planes for the connections. It is a class 6 board. It is 366.7mm high and 160mm wide.

Under each BGA packaged circuit, the wires are 0.13mm wide with 0.13mm insulation. The diameter of the smallest drilling is 0.3mm. Otherwise, elsewhere on the board, wires are 0.18mm wide with 0.18mm insulation, the diameter of the smallest drilling is also 0.3mm.

We have a total amount of 3424 connections including 1051 connections for grounding and low voltage, and 2373 for signals. The number of via on the trigger board is 4691 and we have 7126 wires⁷. Finally, 579 components (including capacitors, resistors) are soldered on the printed circuit.

References:

- [1] J. Dowdell et al., RD-27 collaboration, note 30, A Coincidence Array Demonstrator ASIC for the RD27 Muon Trigger.
- [2] ALICE collaboration, MUON Spectrometer Technical Proposal, CERN/LHCC 96-32 (1996).
- [3] ALICE collaboration, TDR of the MUON Spectrometer, CERN/LHCC 99-22 (1999).

⁷ Wire = connection between two via or a via and a circuit's pin.

5 LOCAL TRIGGER BOARD FUNCTIONS

In its normal working mode, the board computes the Local trigger algorithm and sends the Local decision to the Regional board according to the state of its various inputs and to the control signals on the VME J2 bus. The Local board also allows to store and transmit data to the ALICE DAQ, via the Regional board. A "loading" mode also exists to configure the board, the Masks and the LUT. A precise description of these different modes and of the involved registers follows.

5.1 VME ADDRESSING

The four most significant bits of the board base address are fixed on the J2 VME backplane. It means that a trigger board plugged in a trigger VME crate fetches the bits 17 to 20 of its address directly from the J2 connector. Hence, the leftmost board in the crate has a base address of h'00000⁸, the next one on the right h'20000' up to h'1E0000' for the rightmost board.

We recall that the dimuon trigger VME crates can only accept up to 16 Local boards, one Regional board or one VME controller. The VME access possibilities will be reduced to a minimum as no other type of board than the Local board can be plugged. Hence such VME signals as /LWORD, AM[5:0], /IACK, SYSCLK and /BERR are not used.

For test purposes, the Local trigger board is able to answer to any VME access, except BLOCK transfers, from standard VME processors. It can be addressed in A32 mode as well as in A24 mode. The data are transmitted with 32 bits.

On the J2 bus, four control signals, "LOAD", "MON/OFF" (*Masks on/off*), "OWR" (*overwrite*) and "COINC4/4" (*coincidence 4/4*), are broadcasted to all the Local trigger boards by the Regional board, so that all Local boards are in the same mode. Following is the description of these different operating modes.

5.2 NORMAL MODE

This mode is asserted when "LOAD = 0". The VME controller is then able to access the DaQ registers. Two types of registers can be set apart:

- a few ones that will be systematically readout (with each valid ALICE trigger sequence, see §2.2);
- others, useful to monitor several parameters such as acquisition dead time, single strip counting, etc, that will be acquired upon request only, probably using the process of software trigger provided by the ALICE trigger system.

In this mode, the signals "MON/OFF", "OWR" and "COINC4/4" are active. The use of "OWR" and MON/OFF will be described in §5.3, as both are linked to the Mask registers. "COINC4/4" allows to change the trigger algorithm, as already described in section 3.

5.2.1 REGISTERS SYSTEMATICALLY ACQUIRED

ADDRESS LOAD = 0	REGISTER/CONTENT D32	TYPE
Base + h'0'	X2[15:0], X1[15:0]	Read only
Base + h'4'	X4[15:0], X3[15:0]	Read only

⁸ h'xxxx' means that the number shown is hexadecimal, b'xxxx' means that the number shown is binary.

Base + h'8'	Y2[15:0], Y1[15:0]	Read only
Base + h'C'	Y4[15:0], Y3[15:0]	Read only
Base + h'10'	b"00000000", Board Address[3:0], Local Decision[3:0], Y_trig, Y_pos[3:0], X_dev[4:0], X_pos[4:0]	Read only

Table 5-1: registers acquired systematically.

Table 5-1 shows the registers which are systematically readout. The four first registers contain the value of all the front panel inputs, **after the Masks**. The fifth register holds the computed Local trigger decision (after the LUT) together with the calculated Y_trig, Y_pos, X_dev, X_pos (see section 3) and the board address in the VME crate.

These data, from the time they are computed or received till the DaQ registers, are pipelined at 40MHz so that they are all synchronized. Hence, the trigger information is calculated from the inputs held in the same level of the pipeline. The length of the pipeline is 1200ns (48 clock pulses, fixed value), enough to cope with the latency of the L0 ALICE trigger (see §2.2).

5.2.2 ADDITIONAL REGISTERS ACQUIRED UPON REQUEST

To increase the reliability and the performances of the system, it is foreseen to store additional data in the DaQ circuit (§4.2.3) of the next version of the Local board. A larger FPGA will be required: an Acex EP1K100FC484-2 with twice the logical resources than the EP1K50FC484-2. Table 5-2 describes these registers.

ADDRESS	LOAD = 0	REGISTER/CONTENT	D32	TYPE
Base + h'14'		(L0)[31:0]		Read only
Base + h'18'		(L0) Hold[31:0]		Read only
Base + h'1C'		CLOCK[31:0]		Read only
Base + h'20'		Low Pt No Trigger[31:0]		Read only
Base + h'24'		High Pt No Trigger[31:0]		Read only
Base + h'28'		Low Pt Right Trigger[31:0]		Read only
Base + h'2C'		High Pt Right Trigger[31:0]		Read only
Base + h'30'		Low Pt Left Trigger[31:0]		Read only
Base + h'34'		High Pt Left Trigger[31:0]		Read only
Base + h'38'		Low Pt Straight Trigger[31:0]		Read only
Base + h'3C'		High Pt Straight Trigger[31:0]		Read only
Base + h'40'		X1/Y1[0][15:0], X1/Y1[1][15:0]		Read only
• • •				
Base + h'5C'		X1/Y1[14][15:0], X1/Y1[15][15:0]		Read only
Base + h'60'		X2/Y2[0][15:0], X2/Y2[1][15:0]		Read only
• • •				
Base + h'7C'		X2/Y2[14][15:0], X2/Y2[15][15:0]		Read only
Base + h'80'		X3/Y3[0][15:0], X3/Y3[1][15:0]		Read only
• • •				
Base + h'9C'		X3/Y3[14][15:0], X3/Y3[15][15:0]		Read only
Base + h'A0'		X4/Y4[0][15:0], X4/Y4[1][15:0]		Read only
• • •				

Base + h'BC'	X4/Y4[14][15:0], X4/Y4[15][15:0]	Read only
Base + h'C0'	b"00000000000000000000", SWITCHES[9:0], COMPTXY	Read only
Base + h'C4	RESET	Read only

Table 5-2: additional registers.

The description of these registers follows:

- at address **base + h'14'**: number of (L0) ALICE triggers received since last access to the RESET register. 31 bits for counting, 1 bit overflow;
- at address **base + h'18'**: time elapsed (25ns step) during readout (i.e. how long the (L0) ALICE trigger has been maintained) since last access to the RESET register. 31 bits for counting, 1 bit overflow;
- at address **base + h'1C'**: time elapsed (25ns step) since last access to the RESET register. 31 bits for counting, 1 bit overflow. It can be compared with the value of the previous register to evaluate the acquisition dead time;
- at address **base + h'20'**: number of no low Pt trigger (algorithm answer = b'00') occurred since last access to the RESET register. 31 bits for counting, 1 bit overflow;
- at address **base + h'24'**: number of no high Pt trigger (algorithm answer = b'00') occurred since last access to the RESET register. 31 bits for counting, 1 bit overflow;
- at address **base + h'28'**: number of right low Pt trigger (algorithm answer = b'01') occurred since last access to the RESET register. 31 bits for counting, 1 bit overflow;
- at address **base + h'2C'**: number of right high Pt trigger (algorithm answer = b'01') occurred since last access to the RESET register. 31 bits for counting, 1 bit overflow;
- at address **base + h'30'**: number of left low Pt trigger (algorithm answer = b'10') occurred since last access to the RESET register. 31 bits for counting, 1 bit overflow;
- at address **base + h'34'**: number of left high Pt trigger (algorithm answer = b'10') occurred since last access to the RESET register. 31 bits for counting, 1 bit overflow;
- at address **base + h'38'**: number of straight low Pt trigger (algorithm answer = b'11') occurred since last access to the RESET register. 31 bits for counting, 1 bit overflow;
- at address **base + h'3C'**: number of straight high Pt trigger (algorithm answer = b'11') occurred since last access to the RESET register. 31 bits for counting, 1 bit overflow;

IMPORTANT COMMENT:

The single counting on the strips X1 to X4 and Y1 to Y4 are made with 17 bits counters. In order to save some registers room, only the 16 most significant bits are stored in the DAQ registers. This enables the storage of two strips counting within one 32 bits register.

- at addresses **base + h'40' ... h'5C'**: number of hits on strip **0 ... 15** of X1 or Y1 (alternately) since last access to the RESET register. 15 bits for counting, 1 bit overflow;
- at addresses **base + h'60' ... h'7C'**: number of hits on strip **0 ... 15** of X2 or Y2 (alternately) since last access to the RESET register. 15 bits for counting, 1 bit overflow;
- at addresses **base + h'80' ... h'9C'**: number of hits on strip **0 ... 15** of X3 or Y3 (alternately) since last access to the RESET register. 15 bits for counting, 1 bit overflow;
- at addresses **base + h'A0' ... h'BC'**: number of hits on strip **0 ... 15** of X4 or Y4 (alternately) since last access to the RESET register. 15 bits for counting, 1 bit overflow;
- at address **base + h'C0'**: .The switches configuration SWITCHES[9:0] and COMPTXY.

- SWITCHES[0] = ZERO-up;
 - SWITCHES[1] = ZERO-middle;
 - SWITCHES[2] = ZERO-down;
 - SWITCHES[3] = ZERO-ALLY-LSB;
 - SWITCHES[4] = EN-Y;
 - SWITCHES[5] = OR[1];
 - SWITCHES[6] = OR[0];
 - SWITCHES[7] = x2u;
 - SWITCHES[8] = x2m;
 - SWITCHES[9] = x2d;
 - If COMPTXY=0, the hits on the X strips are counted
 - If COMPTXY=1, the hits on the Y strips are counted.
- at address **base + h'C4'**: RESET register. An access to this register clears all the other registers, from **base + h'0'** to **base + h'BC'**, and alternately sets the hit counters on the strips from X to Y (see COMPTXY). This last point was introduced to limit the size of the DaQ circuit.

Note that all these registers are almost dead time free. They should be read out a few tens of seconds after a reset otherwise they could be in overflow.

5.3 LOADING MODE

The registers accessible in loading mode are given in Tab. 5-3. This mode is asserted when "LOAD = 1". The VME controller is then able to access both the LUT and the Mask registers, depending on the MON/OFF control signal. In this mode the signals "OWR" and "COINC4/4" are inactive.

ADDRESS	LOAD = 1	MON/OFF	REGISTER/CONTENT	D32	TYPE
Base + h'00000'		0	LUT REGISTER N°0		R/W
Base + h'00004'		0	LUT REGISTER N°1		R/W
• • •					
Base + h'1FFF8'		0	LUT REGISTER N°32766		R/W
Base + h'1FFFC'		0	LUT REGISTER N°32767		R/W
Base + h'0'		1	Mask Y2[15:0], Mask Y1[15:0]		R/W
Base + h'4'		1	Mask X2[15:0], Mask X1[15:0]		R/W
Base + h'8'		1	Mask Y4[15:0], Mask Y3[15:0]		R/W
Base + h'C'		1	Mask X4[15:0], Mask X3[15:0]		R/W

Table 5-3: registers accessible in loading mode.

Only the four LSB of data are written to or read from the LUT registers (Tab. 5-4):

LUT REGISTER			
<i>Bit 3</i>	<i>Bit 2</i>	<i>Bit 1</i>	<i>Bit 0</i>
High Pt Bit 1	High Pt Bit 0	Low Pt Bit 1	Low Pt Bit 0

Table 5-4: content of the LUT register.

Each input coming directly from the FEE (i.e. connected on the front panel) can be individually **masked or overwritten** with the corresponding bit in the Mask registers, depending on the MON/OFF and OWR signals. Table 5-5 will ease the understanding:

INPUT	MON/OFF	OWR	Mask	OUTPUT
A	0	X	X	A
A	1	0	0	0
A	1	0	1	A
A	1	1	0	0
A	1	1	1	1

Table 5-5: effects of the Masks.

These masked inputs are then used to compute the trigger response (it offers debugging possibilities of the trigger algorithm) and are also sent as copies on the J3 bus. Finally, it could be useful to keep the possibility of masking a noisy input.

6 INTERFACES

This chapter is dedicated to the description of the way the Local board is electronically and electrically interfaced with the other elements of the system (VME crates, Local neighbours, Regional and Global boards).

6.1 VME CRATES

Each board is plugged in a specific VME crate designed for the experiment. The height of the board, imposed by the size of the front panel connectors, requires that we use VME 9U crates. Data transmissions from and to the VME controller are done via a standard J1 backplane with automatic daisy chain and in-board terminations, and a specific J2 backplane built by Subatech Nantes. Copies from one board to its neighbours pass through a J3 backplane designed in LPC Clermont-Ferrand.

6.1.1 SLOW-CONTROL AND POWER SUPPLIES

The VME crates are from the WIENER company. 11U bins VME crates for 9Ux160mm VME boards, together with a micro-processor controlled 2U fan-tray (*UEL 6020* with 3 DC variable speed fans) have been chosen. The power supply (*UEP 6021*) is hosted at the rear of the crate in the top position.

On the fan-tray, a CAN-BUS interface is provided, enabling the monitoring of several parameters such as:

- fan temperature in °C;
- global power consumption of the crate in W;
- current consumption on DC power supplies (2.5V, 3.3V and 5V) in A;
- values of low voltages in V.

Furthermore, via CAN-BUS, the crates can be switched on and off, which is useful to reset all FPGA configurations, and the fan speed can be adjusted (1200 rpm to 3600 rpm) to control the crate temperature.

	1kHz	10MHz	Supply limit
5V	2.3A 12W	2.8A 14W	100A 500W
2.5V	2.6A 6.5W	11A 28W	100A 250W
3.3V	7.4A 25W	16A 53W	100A 330W

Table 6-1: measured power consumption, extrapolated to 16 Local boards, on each voltage. The limit of the power supplies are indicated in the last column.

Some tests have been carried out in order to measure the power consumption of a single Local trigger board. The FET⁹ has been used, allowing us to trigger all the board inputs at the same time at different rates, from 1kHz to 10MHz. Note that the maximum anticipated flux on one strip in the experiment is 10 000 hits/s. The measured power consumption, extrapolated to a full crate with 16 Local boards, as well as the characteristics of the crate low voltage supplies are indicated in Tab. 6-1. The measurements have been actually done with the Local board prototype 2: the power consumption is expected to be somewhat larger on the 2.5V for the final board (Acex vs Flex ALTERA). However, large safety margins on each voltage have been taken.

The 5V low voltage is sent on the J1 backplane, the 2.5V and 3.3V (which are not VME standard) are delivered on the J2 backplane. The 12V is **NOT** provided.

6.1.2 J1 AND J2 BACKPLANES

All data transmissions between the VME controller and the Local boards use the J1 and J2 backplanes. A standard VME processor can be plugged in the VME crate in order to test the trigger boards even without the final Regional board. However, in this case, a "Regional emulator board" (see section 7) is mandatory.

Picture 6-1 shows the present J2 backplane, where one VME processor (in the leftmost connector) or one Regional board (next right connector), and 16 Local boards (remaining connectors) can be plugged. It is **compulsory** that a VME processor and a Regional board are **not** plugged together in the crate, in order to avoid any bus administration conflict.

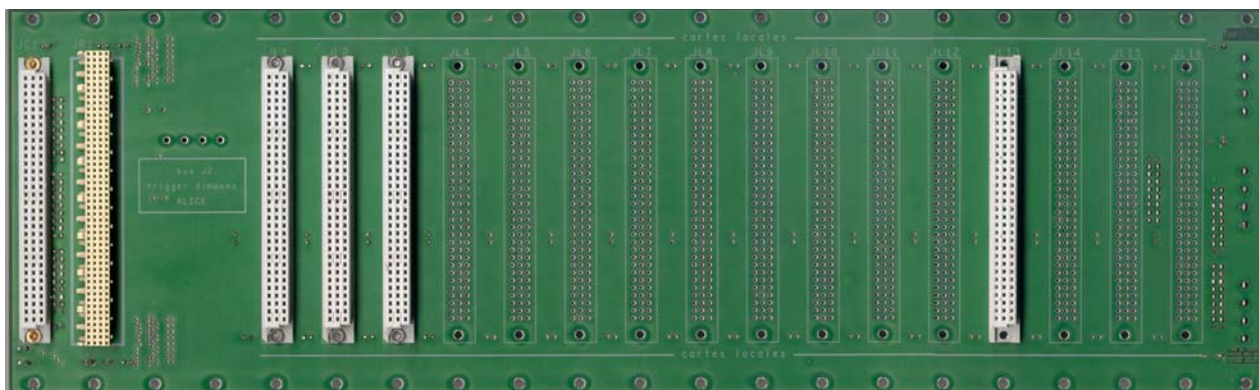

Picture 6-1: J2 Backplane.

The grey connectors are standard 3x32 contact female connectors for VME backplanes (ex.: HARTING, ref.: **09031966825**). The cream color connector, for the Regional board, is a 4x48 contacts connector from FCI, ref. **85967-101**.

As a remainder, the signals driven on J1 and J2 by the VME controller are given in Tab. 6-2 and 6-3:

J1 CONNECTOR VME PROCESSOR	ROW A	ROW B	ROW C
1	D00	/BBSY	D08
2	D01	/BCLR	D09
3	D02	/ACFAIL	D10
4	D03	/BG0IN	D11
5	D04	/BG0OUT	D12
6	D05	/BG1IN	D13
7	D06	/BG1OUT	D14

⁹ Front End Test system.

8	D07	/BG2IN	D15
9	GND	/BG2OUT	GND
10	SYSCLK	/BG3IN	/SYSFAIL
11	GND	/BG3OUT	/BERR
12	/DS1	/BR0	/sysreset
13	/DS0	/BR1	/LWORD
14	/WRITE	/BR2	AM5
15	GND	/BR3	A23
16	/DTACK	AM0	A22
17	GND	AM1	A21
18	/AS	AM2	A20
19	GND	AM3	A19
20	/IACK	GND	A18
21	/IACKIN	SERCLK	A17
22	/IACKOUT	/SERDAT	A16
23	AM4	GND	A15
24	A07	/IRQ7	A14
25	A06	/IRQ6	A13
26	A05	/IRQ5	A12
27	A04	/IRQ4	A11
28	A03	/IRQ3	A10
29	A02	/IRQ2	A09
30	A01	/IRQ1	A08
31	-12V	+5V	+12V
32	+5V	+5V	+5V

Table 6-2: J1 connector for VME processor.

The VME controller must not use the signals in green, as they are needed by the Regional board to send chained JTAG information to the Local boards. In VME specification, the /BGxOUT signals are used for the data transfer arbitration, which is useless in our case, as there is no interrupt handlers. SERCLK and /SERDAT are used for VMSBus, a serial bus used as an alternate data path between bus modules or subracks. Under the VME64 specification these pins were changed to user defined pins. One must check if the chosen VME processor drives these signals or not.

J2 CONNECTOR VME PROCESSOR	ROW A	ROW B	ROW C
1	User defined	+5V	User defined
2	User defined	GND	User defined
3	User defined	RESERVED	User defined
4	User defined	A24	User defined
5	User defined	A25	User defined
6	User defined	A26	User defined
7	User defined	A27	User defined
8	User defined	A28	User defined

9	User defined	A29	User defined
10	User defined	A30	User defined
11	User defined	A31	User defined
12	User defined	GND	User defined
13	User defined	+5V	User defined
14	User defined	D16	User defined
15	User defined	D17	User defined
16	User defined	D18	User defined
17	User defined	D19	User defined
18	User defined	D20	User defined
19	User defined	D21	User defined
20	User defined	D22	User defined
21	User defined	D23	User defined
22	User defined	GND	User defined
23	User defined	D24	User defined
24	User defined	D25	User defined
25	User defined	D26	User defined
26	User defined	D27	User defined
27	User defined	D28	User defined
28	User defined	D29	User defined
29	User defined	D30	User defined
30	User defined	D31	User defined
31	User defined	GND	User defined
32	User defined	+5V	User defined

Table 6-3: J2 connector for VME processor.

The Regional board uses very few control signals from VME specification, so the J1 connector is as follows (Tab. 6-4):

J1 CONNECTOR REGIONAL BOARD	ROW A	ROW B	ROW C
1	D00	GND	D08
2	D01	GND	D09
3	D02	GND	D10
4	D03	GND	D11
5	D04	GND	D12
6	D05	GND	D13
7	D06	GND	D14
8	D07	GND	D15
9	GND	TDI	GND
10	SYSCLK	GND	NC
11	GND	TDO	NC
12	/DS1	GND	NC
13	/DS0	GND	NC

14	/WRITE	GND	GND
15	GND	GND	A23
16	/DTACK	GND	A22
17	GND	GND	A21
18	/AS	GND	A20
19	GND	GND	A19
20	NC	GND	A18
21	NC	TCK	A17
22	NC	TMS	A16
23	NC	GND	A15
24	A07	GND	A14
25	A06	GND	A13
26	A05	GND	A12
27	A04	GND	A11
28	A03	GND	A10
29	A02	GND	A09
30	A01=GND	GND	A08
31	NC	+5V	NC
32	+5V	+5V	+5V

Table 6-4: J1 connector for Regional board.

Most of the VME control signals are forced to ground, that is the reason why it is forbidden to plug in the crate both the Regional board and a VME processor. The JTAG data (TDI, TDO in red) are propagated via the automatic daisy chain pins of the J1 connector and the JTAG control (TCK, TMS in red) passes through the SERCLK and /SERDAT pins.

As seen on Pict. 6-1, the J2 connector for the Regional board (Tab. 6-5) is bigger than usual to deal with the amount of Local trigger data: up to 4x16=64 trigger information in differential mode, plus 16 lines for the VME data bus and other control signals.

J2 CONNECTOR REGIONAL BOARD	ROW A	ROW B	ROW C	ROW D
1	GND	Loc1LP0n	Loc7LP0n	GND
2	+3.3V	Loc1LP0p	Loc7LP0p	+3.3V
3	GND	Loc1LP1n	Loc7LP1n	GND
4	+3.3V	Loc1LP1p	Loc7LP1p	GND
5	GND	Loc1HP0n	Loc7HP0n	LV0n
6	LOAD	Loc1HP0p	Loc7HP0p	LV0p
7	OWR	Loc1HP1n	Loc7HP1n	GND
8	GND	Loc1HP1p	Loc7HP1p	GND
9	COINC4/4	Loc2LP0n	Loc8LP0n	Loc13LP0n
10	MON/OFF	Loc2LP0p	Loc8LP0p	Loc13LP0p
11	GND	Loc2LP1n	Loc8LP1n	Loc13LP1n
12	GND	Loc2LP1p	Loc8LP1p	Loc13LP1p
13	GND	Loc2HP0n	Loc8HP0n	Loc13HP0n

14	GND	Loc2HP0p	Loc8HP0p	Loc13HP0p
15	D16	Loc2HP1n	Loc8HP1n	Loc13HP1n
16	D17	Loc2HP1p	Loc8HP1p	Loc13HP1p
17	GND	Loc3LP0n	Loc9LP0n	Loc14LP0n
18	D18	Loc3LP0p	Loc9LP0p	Loc14LP0p
19	D19	Loc3LP1n	Loc9LP1n	Loc14LP1n
20	GND	Loc3LP1p	Loc9LP1p	Loc14LP1p
21	D20	Loc3HP0n	Loc9HP0n	Loc14HP0n
22	D21	Loc3HP0p	Loc9HP0p	Loc14HP0p
23	GND	Loc3HP1n	Loc9HP1n	Loc14HP1n
24	D22	Loc3HP1p	Loc9HP1p	Loc14HP1p
25	D23	Loc4LP0n	Loc10LP0n	Loc15LP0n
26	GND	Loc4LP0p	Loc10LP0p	Loc15LP0p
27	D24	Loc4LP1n	Loc10LP1n	Loc15LP1n
28	D25	Loc4LP1p	Loc10LP1p	Loc15LP1p
29	GND	Loc4HP0n	Loc10HP0n	Loc15HP0n
30	D26	Loc4HP0p	Loc10HP0p	Loc15HP0p
31	D27	Loc4HP1n	Loc10HP1n	Loc15HP1n
32	GND	Loc4HP1p	Loc10HP1p	Loc15HP1p
33	D28	Loc5LP0n	Loc11LP0n	Loc16LP0n
34	D29	Loc5LP0p	Loc11LP0p	Loc16LP0p
35	GND	Loc5LP1n	Loc11LP1n	Loc16LP1n
36	D30	Loc5LP1p	Loc11LP1p	Loc16LP1p
37	D31	Loc5HP0n	Loc11HP0n	Loc16HP0n
38	GND	Loc5HP0p	Loc11HP0p	Loc16HP0p
39	GND	Loc5HP1n	Loc11HP1n	Loc16HP1n
40	S5	Loc5HP1p	Loc11HP1p	Loc16HP1p
41	S6	Loc6LP0n	Loc12LP0n	GND
42	S7	Loc6LP0p	Loc12LP0p	GND
43	S8	Loc6LP1n	Loc12LP1n	LHC_CLKn
44	GND	Loc6LP1p	Loc12LP1p	LHC_CLKp
45	+3.3V	Loc6HP0n	Loc12HP0n	GND
46	GND	Loc6HP0p	Loc12HP0p	GND
47	+3.3V	Loc6HP1n	Loc12HP1n	+3.3V
48	GND	Loc6HP1p	Loc12HP1p	GND

Table 6-5: J2 connector for Regional board.

On row A of the connector, we can find the remaining VME data signals from D16 to D31, in addition to those on J1. No additional address bits to those on the J1 connector are needed, so they are forced to GND.

The pins in green in Tab. 6-5 correspond to the control signals used to access the Local board (see section 5).

In blue, the signals S5 to S8 give the Regional board its address from 0 to 15.

In red are the (L0) ALICE trigger (Pin D5 and D6) and the 40MHz LHC clock (Pin D43 and D44). They are in LVDS mode, so the "n" means negative and the "p" means positive.

Row B to row D are used for the Regional board to fetch the trigger information sent by the 16 Local trigger boards. For example on pin B48 we have **Loc6HP1p**:

Loc = Local **6** = board number **HP** = High Pt
1 = Bit 1 **p** = positive.

On pin B33 we find **Loc5LP0n**:

Loc = Local **5** = board number **LP** = Low Pt
0 = Bit 0 **n** = negative.

Etc ...

Finally, the Local trigger board is also connected to the J2 backplane with a 3x32 contacts female connector, and the signals are distributed according to Tab. 6-6.

J2 CONNECTOR LOCAL BOARD	ROW A	ROW B	ROW C
1	GND	+5V	GND
2	+3.3V	GND	+3.3V
3	GND	NC	GND
4	+3.3V	NC	+3.3V
5	GND	LV0n	GND
6	GND	LV0p	GND
7	L0HP0n	GND	L0LP0n
8	L0HP0p	GND	L0LP0p
9	GND	LHC_CLKn	GND
10	GND	LHC_CLKp	GND
11	L0HP1n	GND	L0LP1n
12	L0HP1p	GND	L0LP1p
13	GND	+5V	GND
14	GND	D16	GND
15	GND	D17	GND
16	OWR	D18	MON/OFF
17	GND	D19	GND
18	GND	D20	GND
19	COINC4/4	D21	LOAD
20	GND	D22	GND
21	GND	D23	GND
22	S1	GND	S2
23	GND	D24	GND
24	GND	D25	GND
25	S3	D26	S4
26	GND	D27	GND
27	GND	D28	GND

28	GND	D29	GND
29	+2.5V	D30	+2.5V
30	GND	D31	GND
31	+2.5V	GND	+2.5V
32	GND	+5V	GND

Table 6-6: J2 connector for Local board.

The control signals emitted by the Regional board and the Local board address (as described in §5.1) are figured respectively in green and red. This connector is obviously not standard as compared to the one described in Tab. 6-3:

- the +2.5V low voltage is needed to power the core of the FPGA;
- the +5V is for the LUT, the differential emitters for tests and VME signal buffers;
- the +3.3V low voltage supplies the I/O of the FPGA, the LVDS receivers, the source buffers for the signals copies, and all other circuits.

In blue are figured:

- on pins B5 and B6: the (L0) ALICE trigger (input);
- on pins B9 and B10: the 40MHz LHC clock (input);
- on pins A7 and A8: the High Pt Local trigger bit 0 (output);
- on pins A11 and A12: the High Pt Local trigger bit 1 (output);
- on pins C7 and C8: the Low Pt Local trigger bit 0 (output);
- on pins C11 and C12: the Low Pt Local trigger bit 1 (output).

6.1.3 J3 BACKPLANE

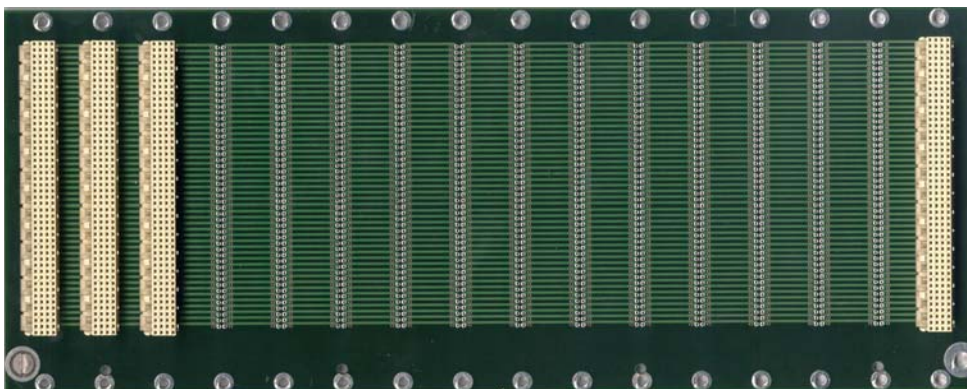

Picture 6-2: J3 backplane.

This backplane (Pict. 6-2) is dedicated to the copy of X and Y signals from one board to its left and right neighbours. It is a four layer board, 3.2mm thick, with two layers for the signals and two layers for grounding. The signals propagate from one connector to its neighbours. Up to 16 Local boards can be plugged in. Each board receives 96 inputs and sends 96 outputs, according to Tab. 6-7.

J3 CONNECTOR	ROW A	ROW B	ROW C	ROW D
48	X4[7]	X3[7]	<i>X3[23]</i>	<i>X4[23]</i>
47	X4[6]	X3[6]	<i>X3[22]</i>	<i>X4[22]</i>
46	X4[5]	X3[5]	<i>X3[21]</i>	<i>X4[21]</i>

45	X4[4]	X3[4]	<i>X3[20]</i>	<i>X4[20]</i>
44	X4[3]	X3[3]	<i>X3[19]</i>	<i>X4[19]</i>
43	X4[2]	X3[2]	<i>X3[18]</i>	<i>X4[18]</i>
42	X4[1]	X3[1]	<i>X3[17]</i>	<i>X4[17]</i>
41	X4[0]	X3[0]	<i>X3[16]</i>	<i>X4[16]</i>
40	<i>X4[15]</i>	<i>X3[15]</i>	X3[31]	X4[31]
39	<i>X4[14]</i>	<i>X3[14]</i>	X3[30]	X4[30]
38	<i>X4[13]</i>	<i>X3[13]</i>	X3[29]	X4[29]
37	<i>X4[12]</i>	<i>X3[12]</i>	X3[28]	X4[28]
36	<i>X4[11]</i>	<i>X3[11]</i>	X3[27]	X4[27]
35	<i>X4[10]</i>	<i>X3[10]</i>	X3[26]	X4[26]
34	<i>X4[9]</i>	<i>X3[9]</i>	X3[25]	X4[25]
33	<i>X4[8]</i>	<i>X3[8]</i>	X3[24]	X4[24]
32	Y_d3[7]	Y_d3[15]	<i>Y3[15]</i>	<i>Y3[7]</i>
31	Y_d3[6]	Y_d3[14]	<i>Y3[14]</i>	<i>Y3[6]</i>
30	Y_d3[5]	Y_d3[13]	<i>Y3[13]</i>	<i>Y3[5]</i>
29	Y_d3[4]	Y_d3[12]	<i>Y3[12]</i>	<i>Y3[4]</i>
28	Y_d3[3]	Y_d3[11]	<i>Y3[11]</i>	<i>Y3[3]</i>
27	Y_d3[2]	Y_d3[10]	<i>Y3[10]</i>	<i>Y3[2]</i>
26	Y_d3[1]	Y_d3[9]	<i>Y3[9]</i>	<i>Y3[1]</i>
25	Y_d3[0]	Y_d3[8]	<i>Y3[8]</i>	<i>Y3[0]</i>
24	Y_d4[7]	Y_d4[15]	<i>Y4[15]</i>	<i>Y4[7]</i>
23	Y_d4[6]	Y_d4[14]	<i>Y4[14]</i>	<i>Y4[6]</i>
22	Y_d4[5]	Y_d4[13]	<i>Y4[13]</i>	<i>Y4[5]</i>
21	Y_d4[4]	Y_d4[12]	<i>Y4[12]</i>	<i>Y4[4]</i>
20	Y_d4[3]	Y_d4[11]	<i>Y4[11]</i>	<i>Y4[3]</i>
19	Y_d4[2]	Y_d4[10]	<i>Y4[10]</i>	<i>Y4[2]</i>
18	Y_d4[1]	Y_d4[9]	<i>Y4[9]</i>	<i>Y4[1]</i>
17	Y_d4[0]	Y_d4[8]	<i>Y4[8]</i>	<i>Y4[0]</i>
16	<i>Y3[7]</i>	<i>Y3[15]</i>	Y_u3[15]	Y_u3[7]
15	<i>Y3[6]</i>	<i>Y3[14]</i>	Y_u3[14]	Y_u3[6]
14	<i>Y3[5]</i>	<i>Y3[13]</i>	Y_u3[13]	Y_u3[5]
13	<i>Y3[4]</i>	<i>Y3[12]</i>	Y_u3[12]	Y_u3[4]
12	<i>Y3[3]</i>	<i>Y3[11]</i>	Y_u3[11]	Y_u3[3]
11	<i>Y3[2]</i>	<i>Y3[10]</i>	Y_u3[10]	Y_u3[2]
10	<i>Y3[1]</i>	<i>Y3[9]</i>	Y_u3[9]	Y_u3[1]
9	<i>Y3[0]</i>	<i>Y3[8]</i>	Y_u3[8]	Y_u3[0]
8	<i>Y4[7]</i>	<i>Y4[15]</i>	Y_u4[15]	Y_u4[7]
7	<i>Y4[6]</i>	<i>Y4[14]</i>	Y_u4[14]	Y_u4[6]
6	<i>Y4[5]</i>	<i>Y4[13]</i>	Y_u4[13]	Y_u4[5]
5	<i>Y4[4]</i>	<i>Y4[12]</i>	Y_u4[12]	Y_u4[4]
4	<i>Y4[3]</i>	<i>Y4[11]</i>	Y_u4[11]	Y_u4[3]

3	<i>Y4[2]</i>	<i>Y4[10]</i>	Y_u4[10]	Y_u4[2]
2	<i>Y4[1]</i>	<i>Y4[9]</i>	Y_u4[9]	Y_u4[1]
1	<i>Y4[0]</i>	<i>Y4[8]</i>	Y_u4[8]	Y_u4[0]

Table 6-7: J3 connector.

The signals in bold correspond to inputs, the ones in italic to outputs. On row A and B are connected all the signals going to and coming from the left board and, on row C and D, the signals going to and coming from the right board. Note that from left to right in the crate corresponds to bottom to top (of a column) at the setup level.

The inputs are as follows:

- pin A41 to A48: the 8 LSB of X4, coming from the left board;
- pin B41 to B48: the 8 LSB of X3, coming from the left board;
- pin C33 to C40: the 8 MSB of X3, coming from the right board;
- pin D33 to D40: the 8 MSB of X4, coming from the right board;
- pin A25 to A32: the 8 LSB of Y3 coming from the left board (the _d means "down");
- pin B25 to B32: the 8 MSB of Y3 coming from the left board;
- pin A17 to A24: the 8 LSB of Y4 coming from the left board;
- pin B17 to B24: the 8 MSB of Y4 coming from the left board;
- pin C9 to C16: the 8 MSB of Y3 coming from the right board (the _u means "up");
- pin D9 to D16: the 8 LSB of Y3 coming from the right board;
- pin C1 to C8: the 8 MSB of Y4 coming from the right board;
- pin D1 to D8: the 8 LSB of Y4 coming from the right board.

The outputs are as follows:

- pin C41 to C48: bits 16 to 23 of X3. They are actually the 8 MSB of the X3 input coming directly from the FEE;
- pin D41 to D48: bits 16 to 23 of X4. They are actually the 8 MSB of the X4 input coming directly from the FEE;
- pin A33 to A40: bits 8 to 15 of X4. They are actually the 8 LSB of the X4 input coming directly from the FEE;
- pin B33 to B40: bits 8 to 15 of X3. They are actually the 8 LSB of the X3 input coming directly from the FEE;
- pin C25 to C32: bits 8 to 15 of Y3 meant for the right board;
- pin D25 to D32: bits 0 to 7 of Y3 meant for the right board;
- pin C17 to C24: bits 8 to 15 of Y4 meant for the right board;
- pin D17 to D24: bits 0 to 7 of Y4 meant for the right board;
- pin A9 to A16: bits 0 to 7 of Y3 meant for the left board;
- pin B9 to B16: bits 8 to 15 of Y3 meant for the left board;
- pin A1 to A8: bits 0 to 7 of Y4 meant for the left board;
- pin B1 to B8: bits 8 to 15 of Y4 meant for the left board.

For example, the pins A41 to A48 of one board are connected through the J3 backplane to the pins D41 to D48 of the board on the left, and the pins B41 to B48 are connected to the pins C41 to C48.

6.2 REGIONAL BOARD AND FEE

The Local trigger board communicates with three different entities:

- the Local board neighbours in the VME crate, through the J3 bus and the transverse connector(s);
- the Regional board, which allows to control the VME crate, to change the Local trigger board configuration, to load the LUT and the Masks on each board, to perform data acquisition, to program (via a JTAG bus) all the configuration EPROMs, to dispatch the LHC clock, and at last to manage the (L0) ALICE trigger;
- the FEE, which sends to the Local trigger boards the information about the fired strips in LVDS format. The active state is 0, in order to avoid any fakes when a differential pair is not connected. Indeed, the Texas Instruments LVDS receivers deliver a logical 1 when the inputs are opened. A short description of the signal transmission from the FEE to the Local trigger is given in Annexe 2.

7 LOCAL TRIGGER BOARD TESTS

In order to validate the functioning of the Local board prototypes, a dedicated test bench has been developed in LPC Clermont-Ferrand with some specific equipment. This test bench will be extended to the production tests. Radiation hardness tests have also been performed in LPC Clermont-Ferrand by means of a neutron generator.

7.1 TEST BENCH

Both the trigger algorithm response and the “speed”¹⁰ of the board must be checked, as well as the VME interface. An exhaustive test of all the possible combinations of the input patterns can obviously not be done because, 224 inputs on the front panel and backplane, lead to roughly 10^{67} different cases!!

7.1.1 TEST BENCH PRINCIPLE

For tests purposes, it is necessary to know and to have the possibility to choose the input pattern values. Also, as mentioned previously, the validation tests must be done “dynamically” to check the speed of the board. “Static” tests can be made using the Mask function.

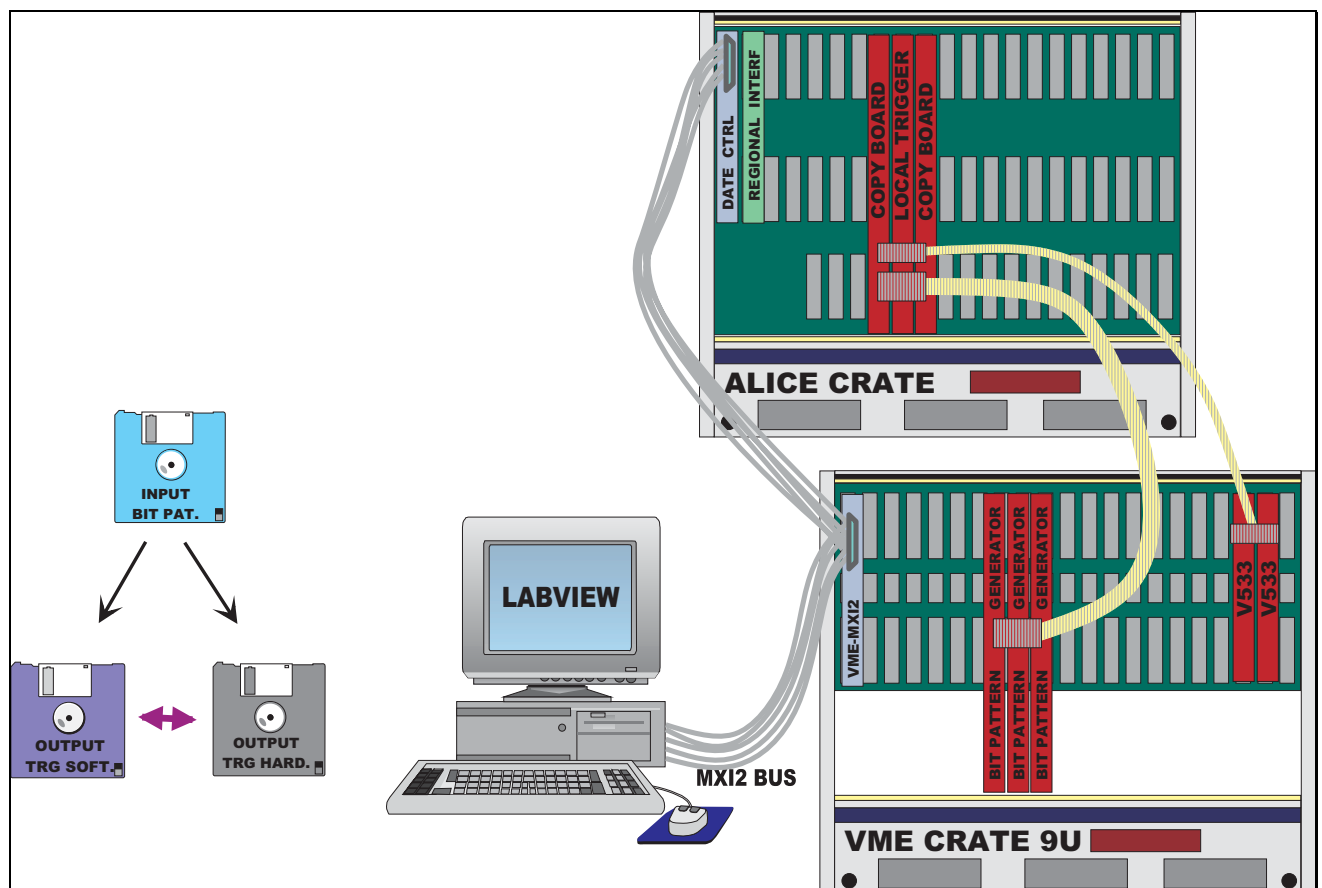

Figure 7-1: sketch of the test bench.

¹⁰ “Speed” = working frequency.

The test bench principle is shown in Fig. 7-1. Selected bit-pattern configurations are loaded in the memories of pattern generators (see §7.1.3). They are then transmitted to a Local trigger board and to “copy boards” (see §7.1.5) at the clock frequency. The Labview VME software interface is used for loading the bit-pattern configurations in the generator as well as for reading out the Local board response through CAEN/V533 VME modules (which are acquisition modules able to work at a frequency up to 40MHz).

7.1.2 ASSOCIATED SOFTWARE

The purpose of this software is to validate the response of the Local trigger board by a comparison with the simulated one. The latter was computed with the ALICE dimuon-trigger software which is part of the official ALICE software [1]. It includes, in particular, an exact copy of the Local trigger algorithm loaded in the FPGA of the Local trigger board. A graphic user interface (Fig. 7-2) allows to:

- generate a high statistics of bit patterns according to pre-defined configurations (to be treated by both software and hardware);
- compute and store the response from a Local trigger board according to a specific setting of its switches;
- compare the response of the software to the response of the hardware.

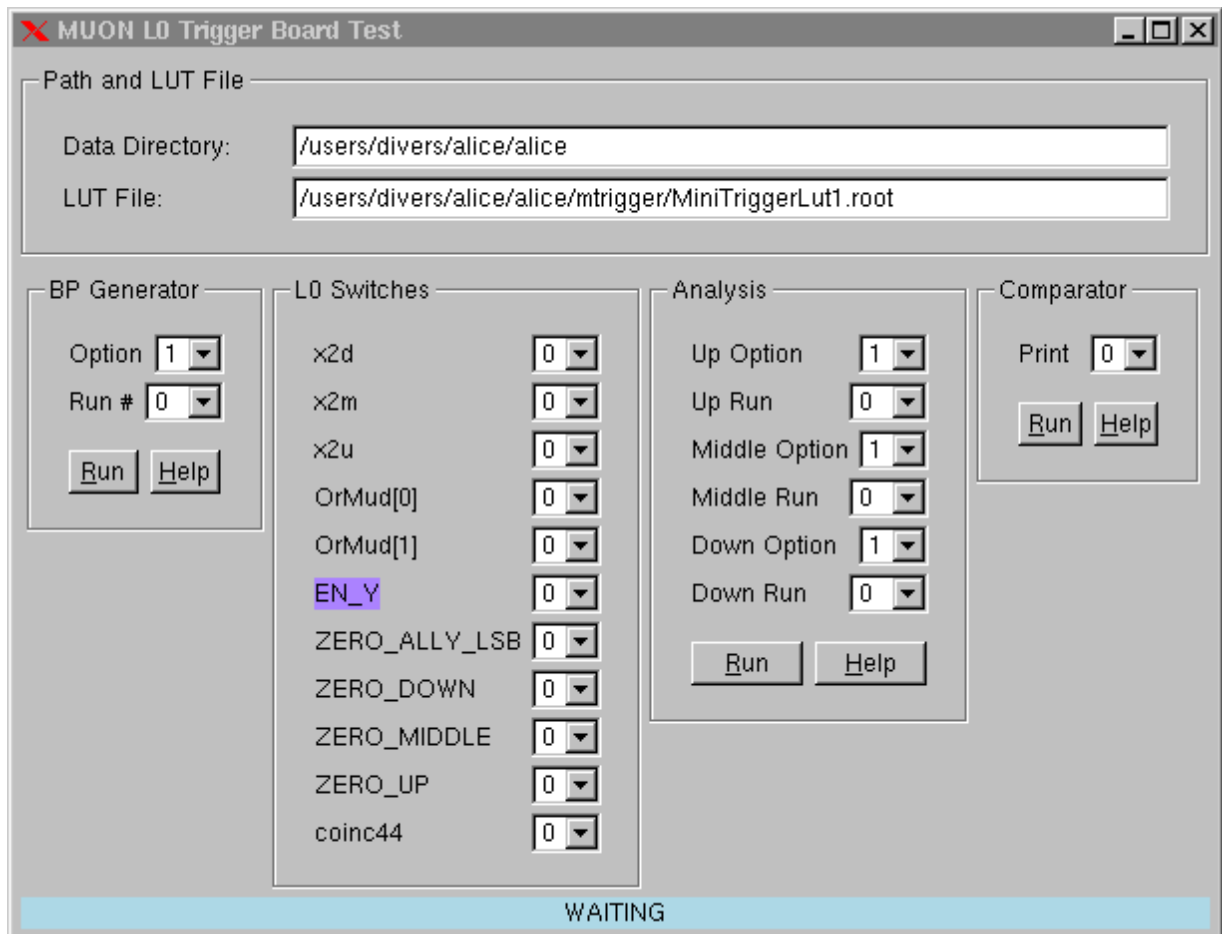
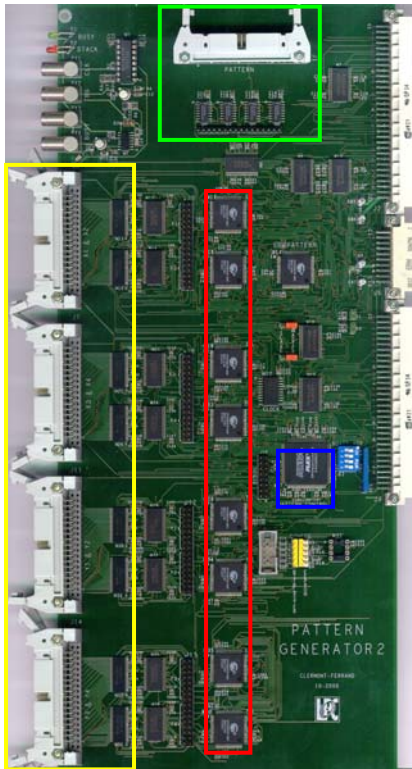

Figure 7-2: graphic user interface used for the tests of the Local trigger board. From left to right are, the generator, the computing of the response according to the switch set, and the comparator between software and hardware responses.

A total of 32000 bit pattern sequences are treated, hardware and software wise, within a few seconds. All possible configurations of the switches for the Local trigger board (third prototype) were considered and successfully tested.

7.1.3 BIT PATTERN GENERATOR



Picture 7-1: bit pattern generator.

For the test bench, we have built a VME compliant bit pattern generator with 128 synchronized outputs in LVDS format. This board (Pict. 7-1) is mainly based on one FPGA (***EPF6016TC144-2***, outlined in blue) driving the VME signals, double port RAMs (***CY7C09279-9AC***, outlined in red) and 16 bit LVDS drivers together with the same connectors as on the Local board front panel (***SN75LVDS387*** and ***3431-L302*** outlined in yellow). It can be clocked at 40MHz and each memory has a depth of 32768 words of 16 bits.

This board is designed to be easily interfaced with industrial data acquisition V533 boards (from CAEN). Three similar boards can work together to “feed” three Local trigger boards in parallel, synchronously. In this mode one board becomes the master, i.e. the one able to start and stop emission, the two other are slaves.

The master board also sends the current pattern number to the V533 with TTL differential drivers through a dedicated connector, which is outlined in green.

The master bit pattern generator is addressed in 32 bits with 16 bits of data and can answer any « standard supervisory data access » (AM=h'0D') and « standard non-privileged data access » (AM=h'09'). The bits[24:21] of the base address are fixed on the board with switches.

The register contents and their addresses are described in Tab. 7-1.

ADDRESS	REGISTER/CONTENT	D16	TYPE
Base + h'00000'	X1[0][15:0]		R/W
	• • •		
Base + h'0FFFE'	X1[32767][15:0]		R/W
Base + h'20000'	X2[0][15:0]		R/W
	• • •		
Base + h'2FFFE'	X2[32767][15:0]		R/W
Base + h'40000'	X3[0][15:0]		R/W
	• • •		
Base + h'4FFFE'	X3[32767][15:0]		R/W
Base + h'60000'	X4[0][15:0]		R/W
	• • •		
Base + h'6FFFE'	X4[32767][15:0]		R/W
Base + h'80000'	Y1[0][15:0]		R/W
	• • •		

Base + h'8FFFE'	Y1[32767][15:0]	R/W
Base + h'A0000'	Y2[0][15:0]	R/W R/W
...		
Base + h'AFFFE'	Y2[32767][15:0]	R/W
Base + h'C0000'	Y3[0][15:0]	R/W
...		
Base + h'CFFFE'	Y3[32767][15:0]	R/W
Base + h'E0000'	Y4[0][15:0]	R/W
...		
Base + h'EFFFE'	Y4[32767][15:0]	R/W
Base + h'100000'	PATTERN N°[0][15:0]	R/W
...		
Base + h'10FFFE'	PATTERN N°[32767][15:0]	R/W
Base + h'120000'	RESET	Write only
Base + h'120002'	START	Write only
Base + h'120004'	STOP	Write only
Base + h'120006'	STATE[2:0]	Read only
Base + h'120008'	N° OF PATTERN SENT[15:0]	Read only
Base + h'12000A'	N° MAX OF PATTERN TO SEND[15:0]	R/W

Table 7-1: registers of the master bit pattern generator.

The description of these registers follows:

- at address **base + h'00000' ... h'0FFFE'**: 32768x16 bit pattern for X1[15:0];
- at address **base + h'20000' ... h'2FFFE'**: 32768x16 bit pattern for X2[15:0];
- at address **base + h'40000' ... h'4FFFE'**: 32768x16 bit pattern for X3[15:0];
- at address **base + h'60000' ... h'6FFFE'**: 32768x16 bit pattern for X4[15:0];
- at address **base + h'80000' ... h'8FFFE'**: 32768x16 bit pattern for Y1[15:0];
- at address **base + h'A0000' ... h'AFFFE'**: 32768x16 bit pattern for Y2[15:0];
- at address **base + h'C0000' ... h'CFFFE'**: 32768x16 bit pattern for Y3[15:0];
- at address **base + h'E0000' ... h'EFFFE'**: 32768x16 bit pattern for Y4[15:0];
- at address **base + h'100000' ... h'10FFFE'**: 32768 x1 n° of the pattern sent;
- at address **base + h'120000'**: a write access at this address resets the state machine running the emission;
- at address **base + h'120002'**: a write access at this address starts the pattern emission;
- at address **base + h'120004'**: a write access at this address stops the pattern emission;
- at address **base + h'120006'**: a read access at this address gives on 3 bits the state of the "state machine":

000	Wait state
001	Emission state

010	Busy state
011	End emission state
100	Reset

Table 7-2: states of the "state machine" running the emission.

- Wait state: the state machine is waiting for an order;
 - Emission state: the patterns are currently sent;
 - Busy state: the V533 are full, so the emission is stopped. It is resumed with a START order;
 - End emission state: all the patterns have been sent;
 - Reset state: reset of the state machine.
- at address **base + h'120008'**: a read access at this address gives the number of patterns already sent;
 - at address **base + h'12000A'**: maximum number of patterns to be sent. If this number is greater or equal to 2^{15} then the emission doesn't stop when the number of patterns sent reaches 32767. The emission of the same patterns starts again.

When a bit pattern generator is configured as a slave (with two jumpers to place on the board), the addressing is slightly different, as less registers are needed. The slave bit pattern generator is addressed in 24 bits with 16 bit data and can answer any « standard supervisory data access » (AM=h'3D') and « standard non-privileged data access » (AM=h'39'). The bits[23:20] of the base address are fixed on the board with switches.

ADDRESS	REGISTER/CONTENT	D16	TYPE
Base + h'00000'	X1[0][15:0]		R/W
• • •			
Base + h'0FFFE'	X1[32767][15:0]		R/W
Base + h'20000'	X2[0][15:0]		R/W
• • •			
Base + h'2FFFE'	X2[32767][15:0]		R/W
Base + h'40000'	X3[0][15:0]		R/W
• • •			
Base + h'4FFFE'	X3[32767][15:0]		R/W
Base + h'60000'	X4[0][15:0]		R/W
• • •			
Base + h'6FFFE'	X4[32767][15:0]		R/W
Base + h'80000'	Y1[0][15:0]		R/W
• • •			
Base + h'8FFFE'	Y1[32767][15:0]		R/W
Base + h'A0000'	Y2[0][15:0]		R/W
• • •			
Base + h'AFFFE'	Y2[32767][15:0]		R/W
Base + h'C0000'	Y3[0][15:0]		R/W

...		
Base + h'CFFFE'	Y3[32767][15:0]	R/W
Base + h'E0000'	Y4[0][15:0]	R/W
...		
Base + h'EFFFE'	Y4[32767][15:0]	R/W

Table 7-3: registers of the slave bit pattern generator.

The description of the registers is the same as for the master generator.

7.1.4 REGIONAL BOARD EMULATOR



Picture 7-2: Regional board emulator.

As previously shown in sections 5 and 6, the Local board needs special control signals (LOAD, MON/OFF, CLOCK, ...) to work properly. A standard VME processor is, obviously, unable to deliver such signals, so we developed a dedicated "emulator" for driving them since the final Regional board was not yet available.

This board (Pict. 7-2) receives (NIM level) the CLOCK on a front panel coaxial connector. The CLOCK is dispatched on the J2 backplane. Another input signal (called L0 trigger) as well as a few output signals exist but they were needed for the mini-trigger experiment (section 8) only.

The Regional board emulator is addressed in 24 bits with 16 bit data and can answer any « standard supervisory data access » (AM=h'3D') and « standard non-privileged data access » (AM=h'39'). The bits[23:16] of the base address are fixed on the board with switches

ADDRESS	REGISTER/CONTENT	D16	TYPE
Base + h'0'	DELAY[5:0]		R/W
Base + h'2'	CONTROL[4:0]		R/W
Base + h'4'	RESET L0		R/W

Table 7-4: registers of the Regional board emulator.

- at address **base + h'0'**: delay, with 25ns step, applied on the L0 trigger signal received on the front panel, from 0ns to 1575ns (63x25ns);
- at address **base + h'2'** (see section 5):

CONTROL REGISTER				
Bit 4	Bit 3	Bit 2	Bit 1	Bit 0
L0	MON/OFF	COINC4/4	OWR	LOAD

Table 7-5: content of the CONTROL register.

- L0: access in read mode only, b'1' if a L0 has occurred else b'0';
- MON/OFF: access in R/W mode, corresponds to the MON/OFF signal on the J2 backplane;
- COINC4/4: access in R/W mode, corresponds to the COINC4/4 signal on the J2 backplane;
- OWR: access in R/W mode, corresponds to the OWR signal on the J2 backplane;
- LOAD: access in R/W mode, corresponds to the LOAD signal on the J2 backplane;
- at address **base + h'4'**: a R/W access at this address forces to 0 the L0 bit of the CONTROL register. Note that, after reception, the L0 state is maintained until an access to this register is made: this emulates the behaviour of the (L0) signal describes in Fig. 2-3 which will be managed by the DarC board.

7.1.5 COPY BOARDS

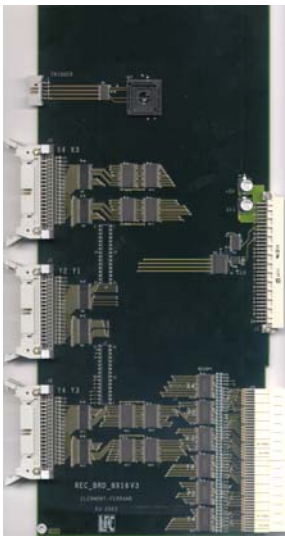

The last of the “home-made” components of the test bench is the copy board (Pict. 7-3). Indeed, in order to avoid any additional costs during the prototyping phase, a special board was built with a single function: to propagate the signals received from the bit pattern generator on the J3 backplane and on the transverse connectors. It avoids having many (three at least) Local board prototypes of each generation.

This board receives (X3, X4, Y1, Y2, Y3 and Y4) information, sends (Y1, Y2, Y3, Y4) on the transverse connectors, and (X3, X4, Y3, Y4) on the J3 connector through two DFF registers, to preserve the same timing as on the Local board.

This board fetches its clock on the J2 backplane, like the Local trigger board.

Picture 7-3: copy board.

7.2 RADIATION TESTS WITH 14 MEV NEUTRONS

The radiation sensitivity (S.E.U.: Single Event Upset rate) of the Local trigger board to 14MeV neutrons has been tested in LPC Clermont-Fd by means of the neutron generator facility. This generator produces 10^8 n/s in 4π . Note that the S.E.U. cross section for 14 MeV neutrons is already about one half of the S.E.U. cross section for 60-200 MeV protons or neutrons, which are considered to provide a relevant test of the kind of electronics equipping the Local trigger board.[2].

The complete test bench of the Local board has been operated. Only the Local crate was exposed to radiations, as shown in Pict. 7-4. This allows to monitor the Local board response all along the irradiation period. The test bench was cycling on a file of 32768 different bit pattern sequences, and the response files were recorded on disk (each ~5s, called a “run”).



Picture 7-4: setup of the test at the neutron generator

FLUKA simulations of the radiation level in the ALICE cavern [3] indicate a fluence of neutrons with kinetic energy $E_{kin} > 10$ MeV of about 10^7 n/cm² integrated over ten years running in ALICE, at the location of the trigger electronics. This radiation level is quite low as compared for example to the one reached in the muon system of ATLAS [4] which is two orders of magnitude more. This fluence is reached in 20mn with the neutron generator, with obviously neutrons of constant kinetic energy $E_{kin} = 14$ MeV.

Two irradiation periods have been done, spaced out by a week. The periods have lasted respectively 3 hours and 4 hours 20mn. It corresponds to 22 times the expected total fluence in ALICE.

During all the irradiation, no major crash, so-called latch-up, of the system has been observed.

The program of the Flash Memory has not been lost i.e. no S.E.U. occurred. Such a result is not surprising since Flash Memories are known to be highly radiation tolerant (see reference [4]). As a consequence, this means that a ON/OFF of the crate is sufficient to reset all FPGA configurations.

A total of 9 cases of FPGA program loss caused by S.E.U. have however occurred. In most of the cases, the effect is a slight modification of the trigger algorithm: one sequence (or a few sequences) among the 32768 delivers a false response. The algorithm "default" stays, from run to run, until a reset of the crate is made. This has been observed mainly on the L0-X algorithm but also on the L0-Y (1 case) and on the LUT response (2 cases). Random bit jumps from run to run have **not** been observed: in other word, the Local board response was exactly identical from run to run, correct or partly wrong, as discussed previously.

Assuming that the effects of 20mn of irradiation with 14 MeV neutrons is equivalent to 10 years in ALICE, only one FPGA program loss per month (i.e. one crate reset per month) would be expected during ALICE running, for the 234 Local boards. A permanent monitoring of the trigger algorithm is in any case foreseen during the experiments.

References:

[1] <http://AliSoft.cern.ch/offline/>

[2] M.Huhtinen and F. Faccio, Nucl. Instrum. Meth. A450 (2000) 155.

[3] <http://morsch.home.cern.ch/morsch/NeutronFluence.html>

[4] V.Bocci et al., proceedings of the 7th workshop on Electronics for LHC Experiments, Stockholm, Sweden, Sept 2001, p137.

8 THE MINI-TRIGGER EXPERIMENT

The performances of a reduced-size prototype of the dimuon trigger, called the “mini-trigger”, have been investigated during a test performed at the CERN/GIF (Gamma Irradiation Facility [1]).

The setup (Fig. 8-1) consists in four $50 \times 50 \text{ cm}^2$ RPC planes, geometrically spaced like in ALICE, perpendicular to the beam. Two $30 \times 30 \text{ cm}^2$ scintillator hodoscopes are placed upstream and downstream the RPCs. Each RPC is readout on both sides by 16 X-Y orthogonal strips. The length and width of the strips are 50cm and 2cm, respectively. The FEE uses the ADULT ASIC [2]. The X-Y pattern of the fired strips is transmitted to a Local trigger board, in LVDS differential mode, along 25m long cables. Here the signals are latched and sampled at the 40MHz clock frequency and the trigger algorithm is executed. The fired strip pattern as well as the response at different stages of the algorithm are stored in the DaQ pipeline of the Local trigger board.

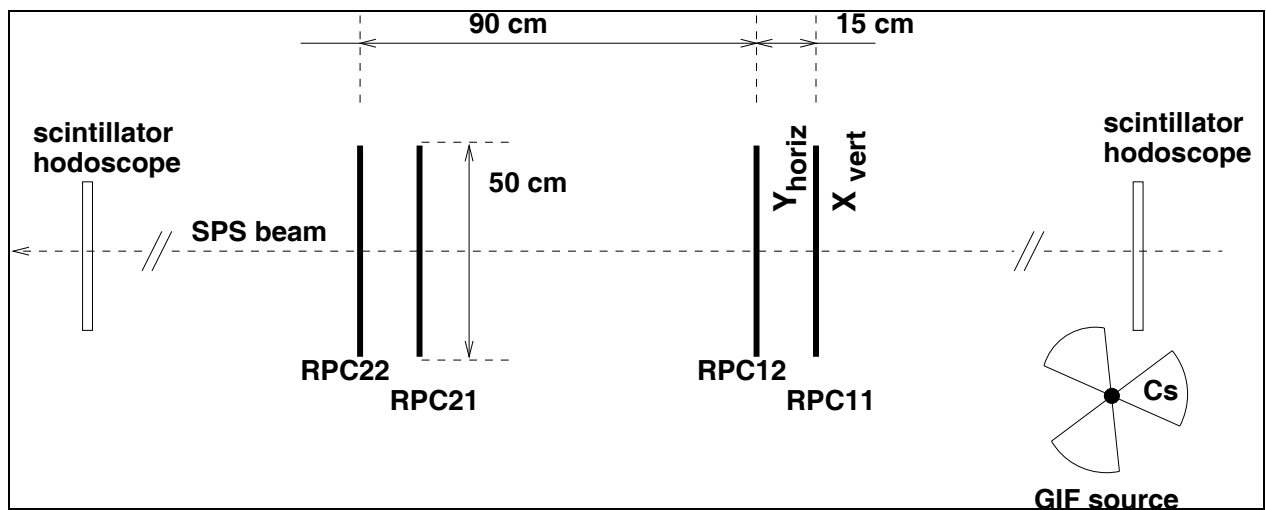

Figure 8-1: sketch of the experimental setup of the mini-trigger experiment at CERN/GIF.

The test has been carried out with the 120GeV/c SPS muon beam. The intense photon flux of the GIF induces a non-correlated background on the detectors. At the setup location, the maximum background rate is 320 (110) Hz/cm² on the detector close to (far from) the source. The background rate can be varied by means of absorbers.

The DaQ pipeline is readout on occurrence of a trigger signal. The trigger may be delivered by:

- the scintillator hodoscopes, when a beam muon is detected. Note that the hodoscopes are protected from the GIF background. Such a trigger is used for the determination of the track-finding efficiency of the mini-trigger. The track deviation measured by the mini-trigger is close to zero (Fig. 8-2) since the beam direction is orthogonal to the setup. Note that the alignment accuracy was not better than a few mm in this test. Of course, no cuts on the deviation are performed (by mean of the Look-Up-Table of the Local trigger board) for the track-finding efficiency measurements;
- the Local trigger board itself, after the trigger algorithm is executed. This actually corresponds to the standard running in ALICE. The track finding efficiency is 100% by definition in this case. The rates of this trigger at various background level, with beam off, gives useful information about the robustness of the setup against uncorrelated background.

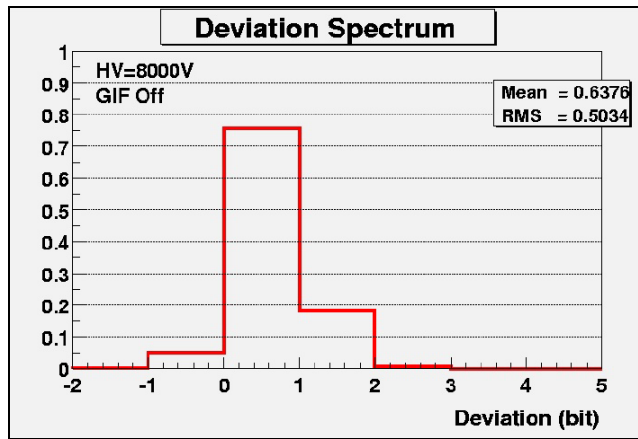

Figure 8-2: track deviation (X_{dev} , see section 3) in bit unit given by the Local trigger algorithm, for a RPC running voltage of 8kV with GIF off. One bit corresponds roughly to the half width of a strip.

The main results can be summarized as follows:

- the track-finding efficiency, vs. the RPC running voltage, reaches a plateau at 98% (94%) level, regardless of the background rate, with the 3/4 (4/4) coincidence requirement (Fig. 8-3). The 2% efficiency loss with the 3/4 coincidence requirement is mainly attributed to the overlap of the RPC spacers with respect to the beam direction;

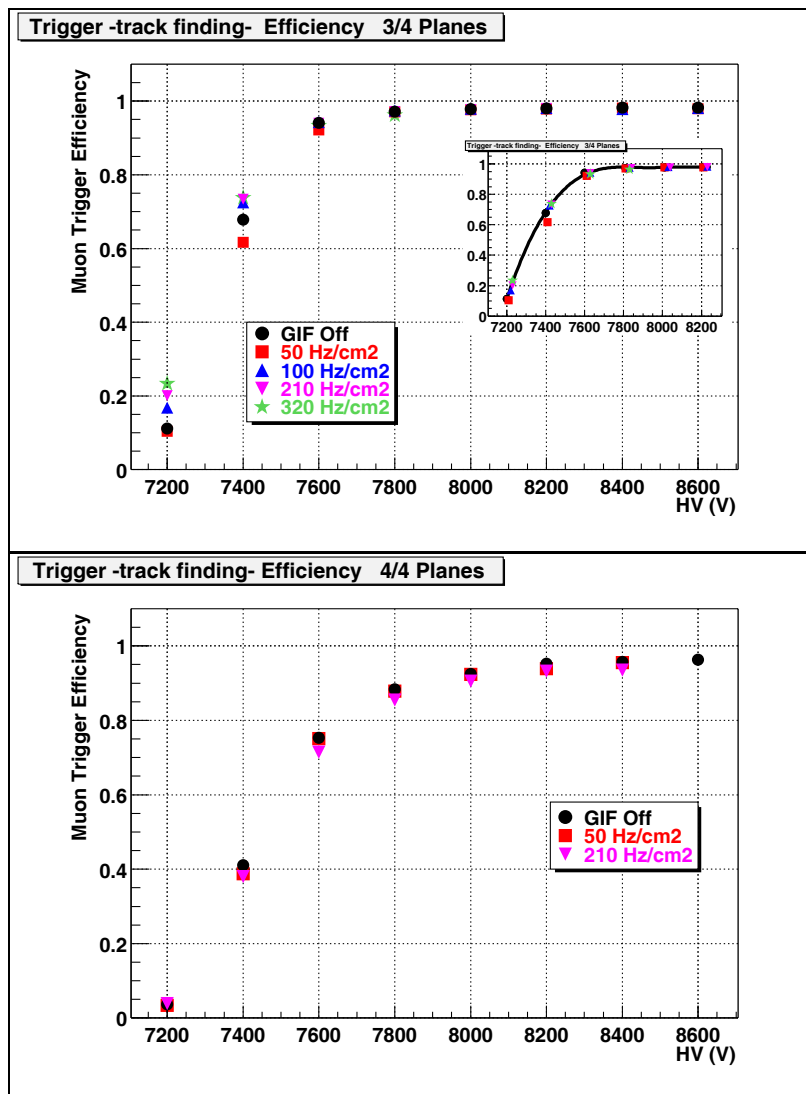

Figure 8-3: track finding efficiency with the 3/4 (top) or 4/4 (bottom) coincidence requirement vs. the RPC running voltage, for different background rates.

- the clock phase must be optimised to latch the signal from the FEE with the goal of maximizing the track-finding efficiency. Note that the beam muons which are synchronous with the clock (within $\pm 2.5\text{ns}$) are previously selected by means of a dedicated electronic device. The track-finding efficiency vs. the clock phase is shown in Fig. 8-4, for GIF off, with the 3/4 coincidence requirement. A $\sim 10\text{ns}$ wide plateau at 98% efficiency is reached for three RPC running voltages (HV=7600V corresponds to the efficiency knee of the detectors). It demonstrates that, despite all sources of timing dispersion, a sufficient safety margin is left for the timing optimisation;
- in the mini-trigger experiment, the optimal clock phase is found easily thanks to the scintillator hodoscopes. It is shown in Fig. 8-5 that the best clock phase can also be determined self-consistently, without external reference, by the ratio of the trigger yields with the 4/4 over the 3/4 coincidence requirement. The values of this ratio are peaked at the optimal value of the clock phase and are moreover correlated with the value of the tracking efficiency itself. This looks very promising and will be available for each Local trigger board in ALICE;
- the trigger rate delivered by the Local board itself with the 3/4 coincidence requirement, beam off, is of the order of 3 per minute at the maximum background. The extrapolation of this result to ALICE conditions is however not straightforward because the background is expected to be more complex.

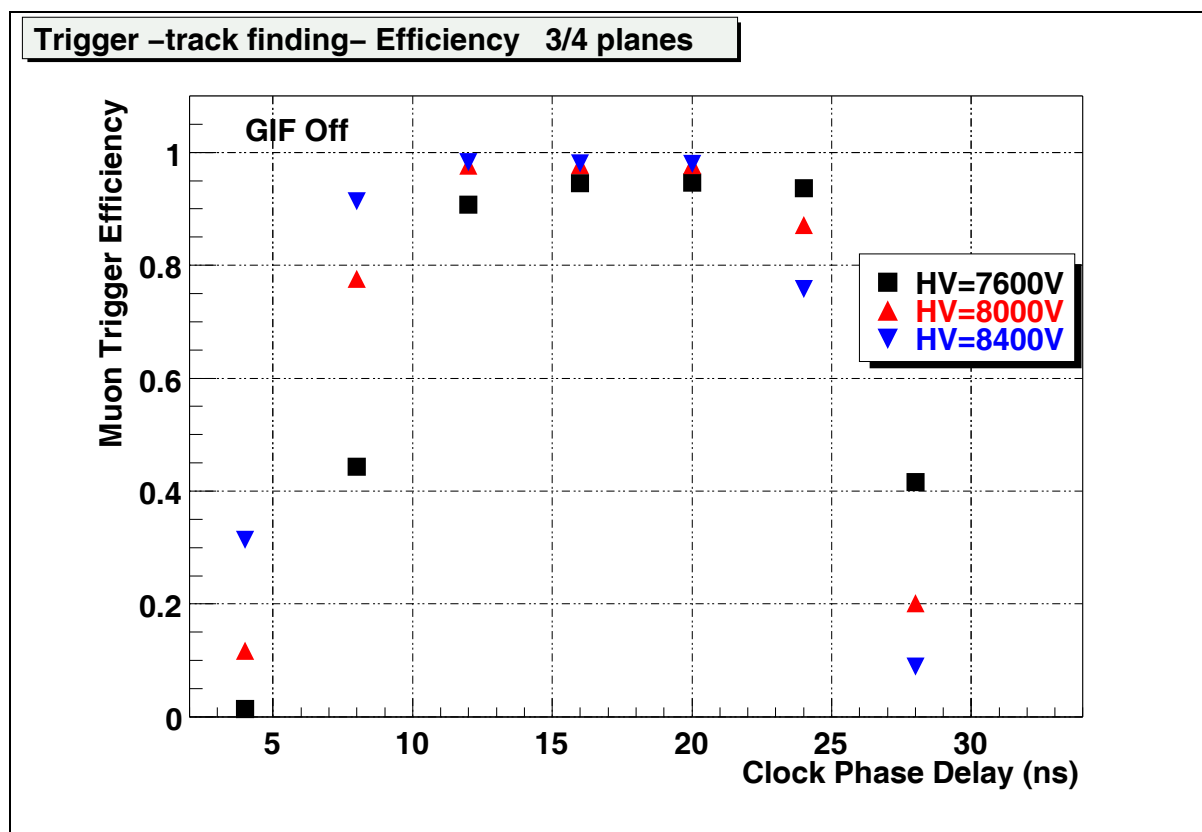

Figure 8-4: track finding efficiency with the 3/4 coincidence requirement vs. the clock phase, for different RPC running voltages with GIF off.

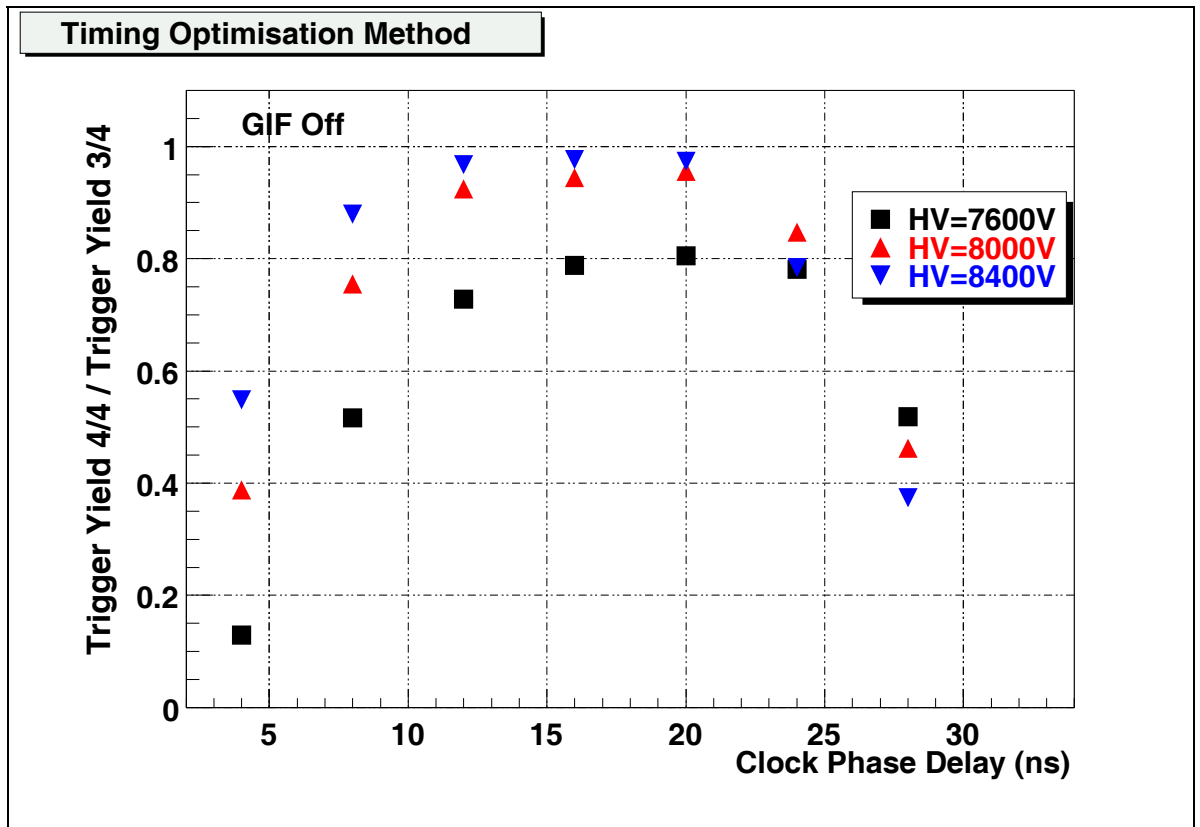

Figure 8-5: ratio of the Local trigger yield with the 4/4 over the 3/4 coincidence requirement vs. the clock phase, for different RPC running voltages with GIF off.

References:

[1] S. Agosteo et al., Nucl. Instrum. Meth. A 452 (2000) 94.

[2] R. Araldi et al, Nucl. Instrum. Meth. A 457 (2001) 117;

P. Dupieux et al., a new front-end for better performances of RPC in streamer mode, Nucl. Instrum. Meth. A, (in press).

9 CONCLUSIONS

9.1 PLANNING AND MILESTONES

The planning and milestones for the Local trigger board are summarized in Tab. 9.1.

A pre-production of 20 Local trigger boards is scheduled in 2003. A complete Local crate will be assembled, with its Regional controller. The crate will be equipped and configured like one of the final ALICE ones, namely the Local boards will be tested with their final switch configuration. The final crate prototype itself is available, including the J2 and J3 bus. It is foreseen to check the response of the algorithm of each board at the 40MHz clock frequency (see section 7) and also to check their VME readout capabilities.

After validation of the pre-production, the final production of the Local boards will be launched. The tests of the production will be performed in the same way as those of the pre-production. The validation of the production is expected to be finished in March 2005. Note that all crates have been ordered and should be delivered in 2003.

A consistency check with the DaQ test bench developed in Subatech Nantes will be performed before the installation in the ALICE cavern, presently scheduled in January 2006.

There are four LHCC milestones linked to these activities:

N°122	Start Production of trigger electronics	Sep. 03
N°436	End production of trigger electronics	Mar. 04
N°442	End tests	Feb. 05
N°443	Ready to install	Jan. 06

Table 9-1: planning and milestones for the Local trigger boards.

9.2 MAINTENANCE AND SPARES

The Local crates are located on the gangways in the ALICE cavern, at the level of the top of the muon trigger. They will be easily accessible when the ALICE cavern will be in free access mode.

A few hardware tools have been implemented in the Local boards and in the FEE for setting up and monitoring remotely the detector. Among these tools, let us mention:

- the Front-End Test (FET) system, already mentioned in section 7. It will allow to check in one shot the correct functioning as well as the correct timing of all the trigger channels from FEE to Local trigger board DaQ;
- the possibility to force the input patterns, through the Mask circuits of a Local board, to known values for checking the trigger algorithm;
- the possibility to mask any chosen input if it is found noisy.

These tools will be controlled from the DaQ system. The detection and the diagnostic of a possible failure of a Local board will be deduced from the information contained in the event readout (DaQ pipeline of the Local boards, Local board scalers).

If the diagnostic is the de-programming of one of the Local board, the best solution is to switch off and on its Local crate by mean of the DCS: the trigger algorithm is automatically loaded in the FPGA of the Local boards when the crates are powered on. If needed, the algorithm can be remotely re-loaded in the FPGA in a few seconds (or the Flash memory can be re-programmed but it takes a longer time).

Obviously, a Local board can be removed and replaced. The time needed for exchanging a faulty Local board is estimated to be a few minutes. An access to the ALICE cavern is of course needed.

Our spare policy will be the following:

- 10% fully cabled and equipped Local boards. The nominal number is 234 Local boards. With the spares, it will amount to a total of 260 Local boards;
- 20% additional programmable circuits, which will be probably not anymore available in a few years. The printed circuit, the connectors and the other components of the board seem less critical in this regard.

9.3 MANPOWER

The present evaluation of the necessary resources in manpower are:

- Up to the end of the tests of the production in March 2005:
 - 1 Engineer in electronics;
 - 1 Physicist;
 - 1 Technician (half time).
- After March 2005 and up to the installation in ALICE:
 - 1 Engineer in electronics;
 - 1 Engineer in DaQ;
 - 2 Physicists;
 - 1 Technician.

9.4 FINANCIAL ASPECTS

An evaluation of the total price of the Local trigger electronics is given in Tab. 9-2. It amounts to 177k€ for 260 boards. Local board spares are included in the estimation as well as 20% additional spares of programmable circuits. An extra cost of about 7k€ is expected for larger DaQ circuits (for scalers). It fits within the CORE cost anticipated budget.

In 2003, we foresee to buy 20 Local boards (pre-production) and all the FPGA. It represents about half of the total budget. The remaining boards and components will be bought in 2004 after the validation of the pre-production.

The Local crates have already been ordered to the WIENER company, following the CERN tender IT-2916/EP and the contract B1186-EP. The total price for 18 crates (incl. 2 spares) was 77k€, proposition of price N°22/0617UV01.

COST EVALUATION (UNIT = euros)						
REFERENCE	MANUFACTURER	DESCRIPTION	PER BOARD	TOTAL	UNIT PRICE	TOTAL PRICE
EP1K50FC484-2	ALTERA	Masks and DaQ	3	780	41,00	31 980
EP1K30FC256-2	ALTERA	TRIGGER Y	1	260	22,00	5 720
EP1K100QC208-1	ALTERA	TRIGGER X	1	260	54,00	14 040
EPC8QC100	ALTERA	EPROM CONFIGURATION	1	260	35,00	9 100
CY7C192-12VC	CYPRESS	LUT	1	260	8,89	2 311
DS90LV018ATM	NATIONAL SC	LVDS RECEIVER 1 ch (CLK + L0)	2	520	0,93	484
DS90LV031ATM	NATIONAL SC	LVDS TRANSMITTER LOCAL TRIGGER	1	260	2,69	699
DS26C31TM	NATIONAL SC	TRANSMITTERS for TESTS	5	1300	0,29	377
SN75LVDS386DGG	TEXAS	LVDS RECEIVERS 16 ch (X and Y)	8	2080	8,69	18 075
74ABT16244A	TEXAS	16 BITS BUFFER/DRIVER	3	780	0,86	671
74LVTH16244A	TEXAS	16 BITS BUFFER/DRIVER	6	1560	1,39	2 168
74LVTH244A	TEXAS	8 BITS BUFFER/DRIVER	2	520	0,62	322
3431L302	3M	FRONT FACE CONNECTORS	4	1040	0,12	127
2534-6002	3M	TEST CONNECTORS	2	520	1,40	728
85824-101	FCI	BACKPLANE CONNECTORS 96 CONTACTS (J3)	2	520	6,40	3 328
BCS-116-L-D-PE	SAMTEC	FEMALE CONNECTOR (TRANSVERSE)	4	1040	1,70	1 768
HW-16-09-G-D-447-SM	SAMTEC	MALE CONNECTOR (TRANSVERSE)	4	1040	1,70	1 768
		FRONT FACE VME	1	260	10,21	2 655
9031966921	HARTING	BACKPLANE CONNECTORS 96 CONTACTS (J2)	2	520	0,98	510
		CAPACITANCE 1,0N 0805	126	32760	0,03	839
		CAPACITANCE 100N 0805	126	32760	0,03	839
		POLARISED CAPACITOR 100µF	4	1040	0,14	141
		POLARISED CAPACITOR 10µF	9	2340	0,06	131
		RESISTOR 100Ohms 1206	2	520	0,03	16
		RESISTOR 120Ohms 1206	64	16640	0,01	95
		RESISTOR 120Ohms 0603	64	16640	0,01	83
		RESISTOR 1KOhms 1206	4	1040	0,03	31
		RESISTOR 51,1Ohms 1206	96	24960	0,01	142
LOCAL TRIGGER	TEHCI	PRINTED CIRCUIT	1	260	76,22	19 817
CABLING	ARDELEC		1	260	50,00	13 000
	ALTERA/CYPRESS	FPGA and SRAM (20% SPARES)				12 000
EP1K100FC484-2	ALTERA	SCALERS DaQ (additional cost only)	1	260		7 000
		INTERFACE CARDS (COLUMNS with 22 BOARDS)		8	500,00	4 000
		SPLIT CARDS (COLUMNS with 22 BOARDS)		12	500,00	6 000
		TEST BENCH EQUIPEMENT		1		8 000
		TOOLING		1		8 000
GRAND TOTAL						176 965

Table 9-2: evaluation of the price of the Local trigger electronics.

ANNEXE 1: LOCAL BOARD TECHNICAL DRAWINGS

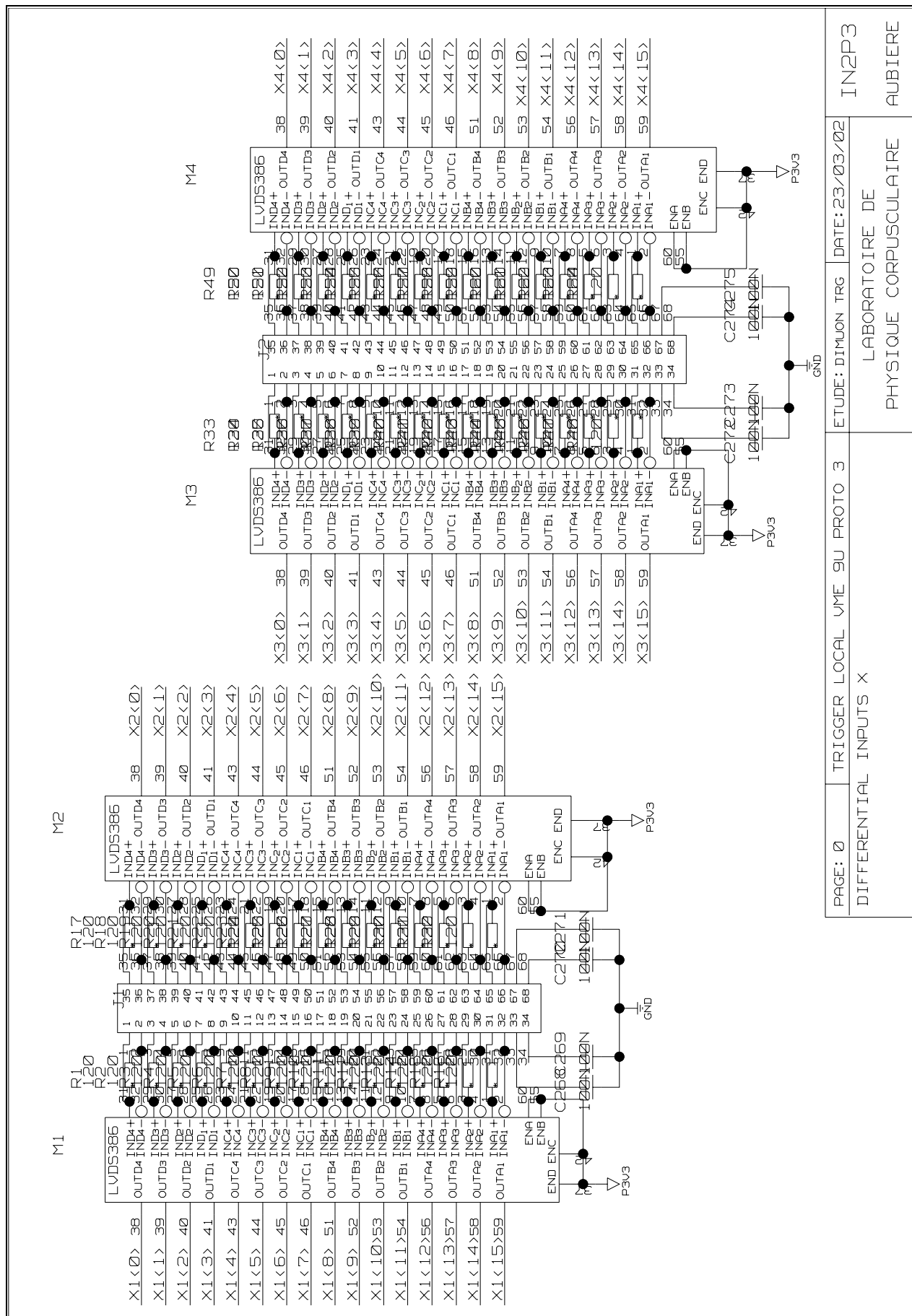

PAGE: 0	TRIGGER LOCAL VME 9U PROTO 3	ETUDE: DIMUON TRG	DATE: 23/03/02	IN2P3
DIFFERENTIAL INPUTS X		PHYSIQUE CORPUSCULAIRE		AUBIERE

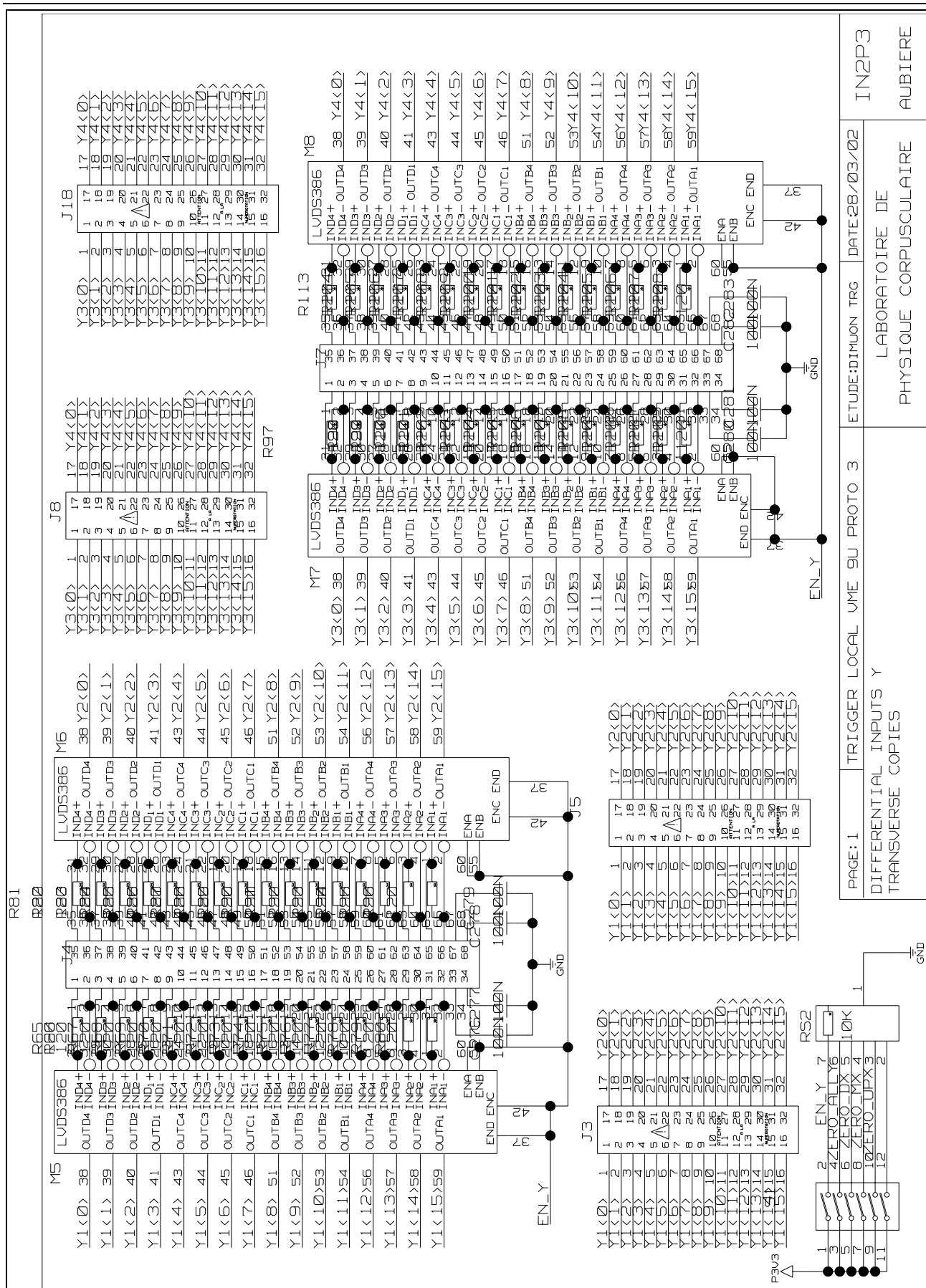

PAGE: 1	TRIGGER LOCAL VME 9U PROTO 3	ETUDE:BTMUON TRG	DATE:28/03/02
DIFFERENTIAL INPUTS Y		LABORATOIRE DE	
TRANSVERSE COPIES		PHYSIQUE CORPUSCULAIRE	
			IN2P3
			AUBIERE

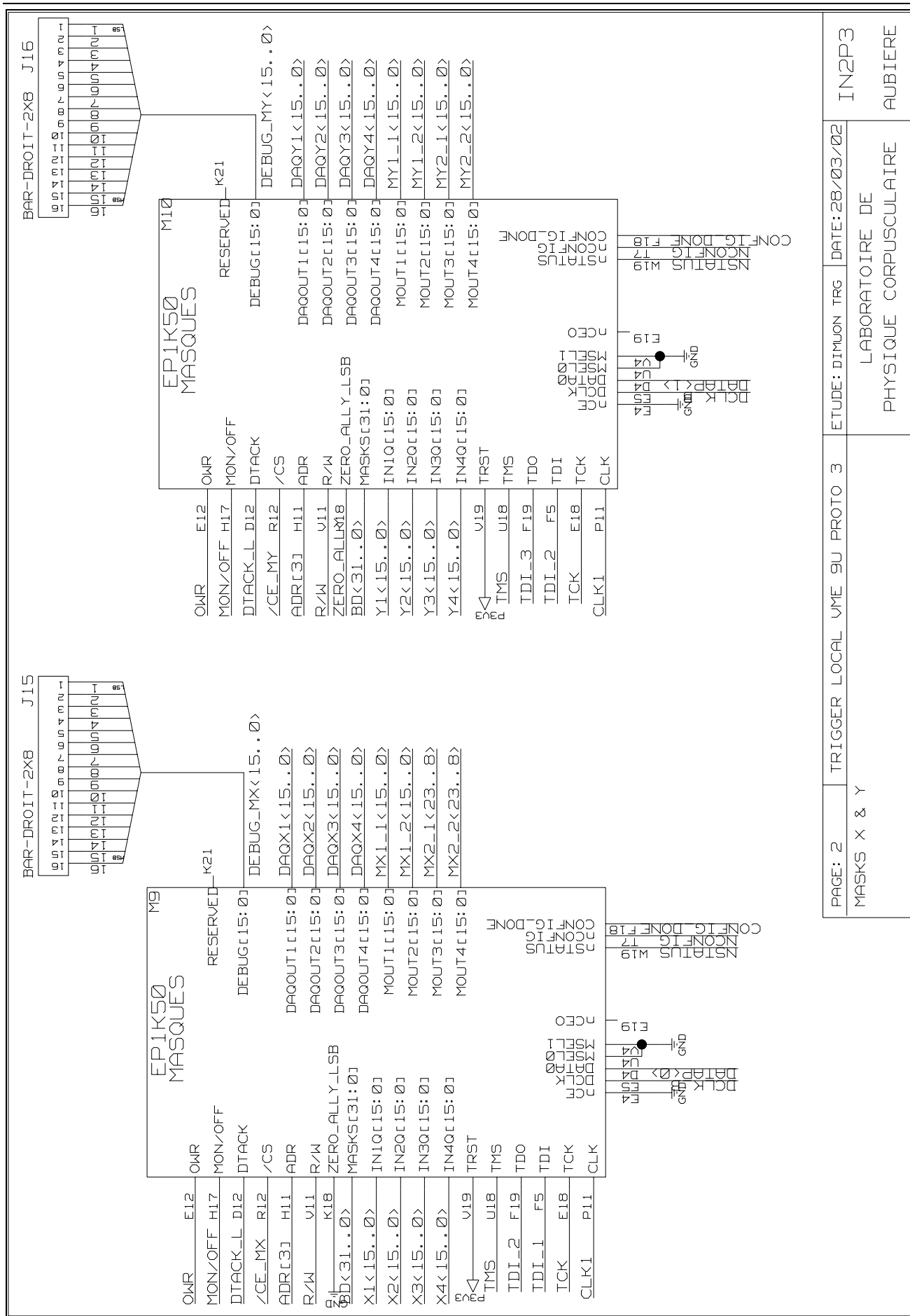

PAGE: 2	TRIGGER LOCAL VME 9U PROTO 3	ETUDE: DIMUON TRG	DATE: 28/03/02	IN2P3
MASKS X & Y		LABORATOIRE DE PHYSIQUE CORPUSCULAIRE		AUBIERE

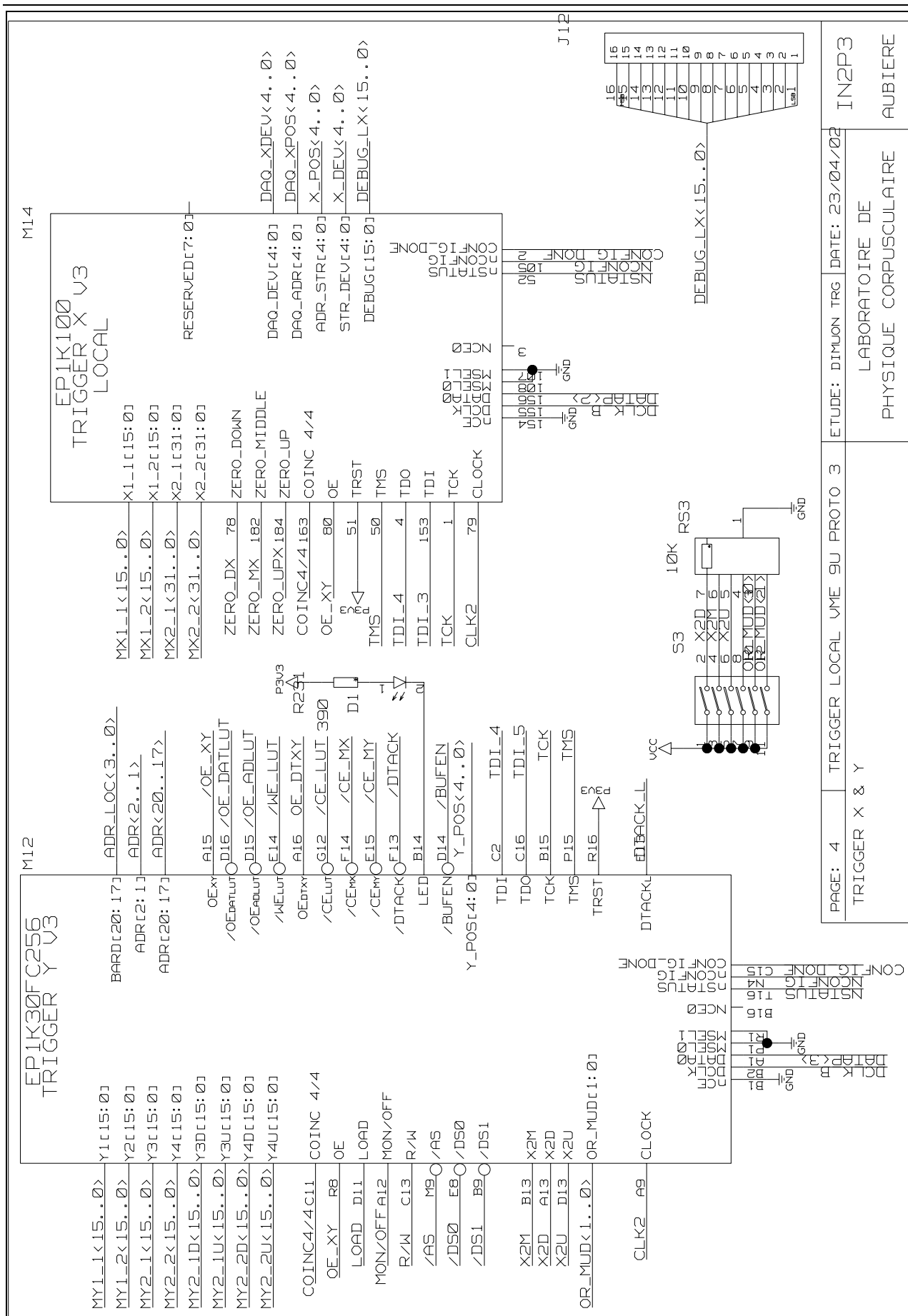

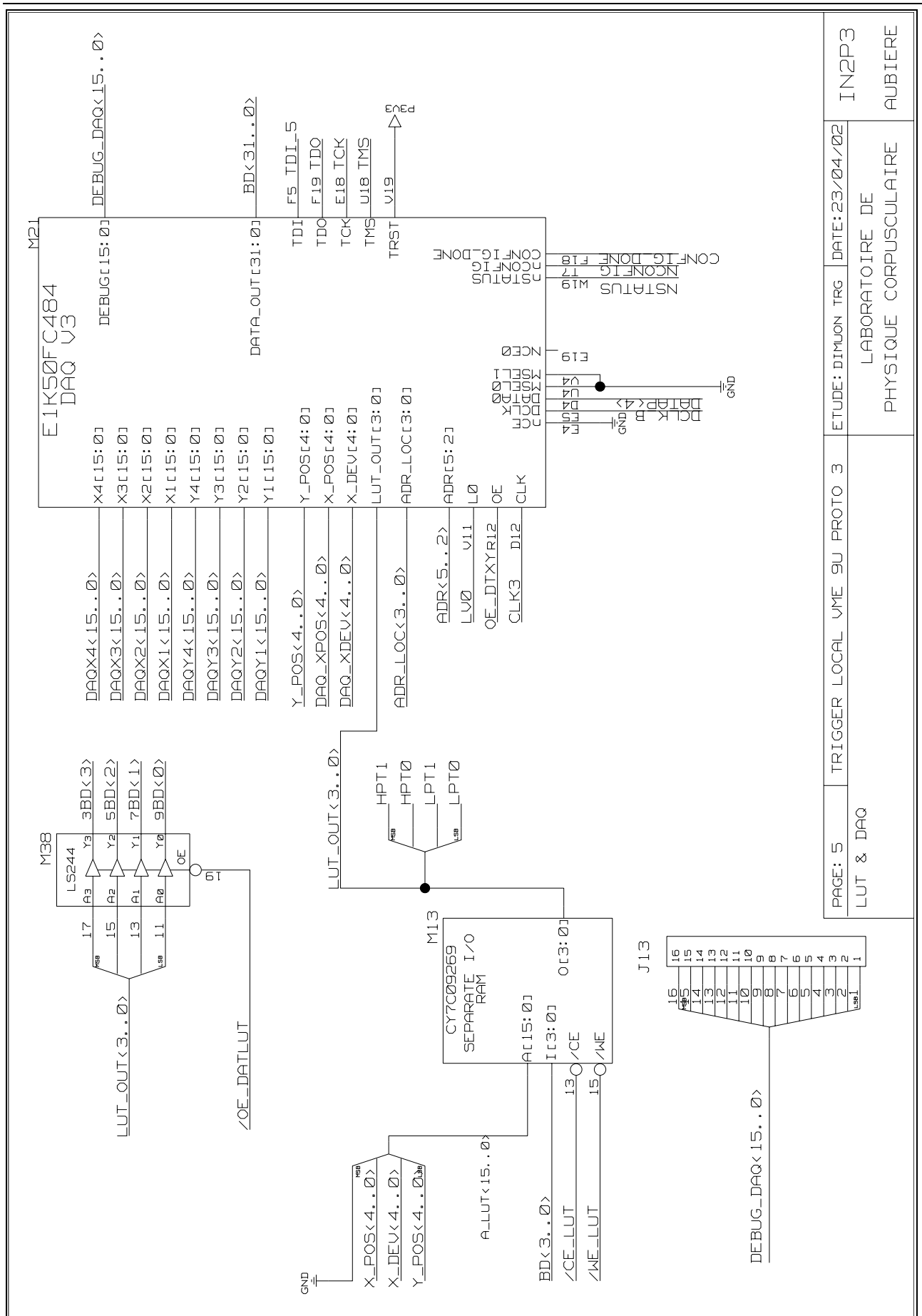

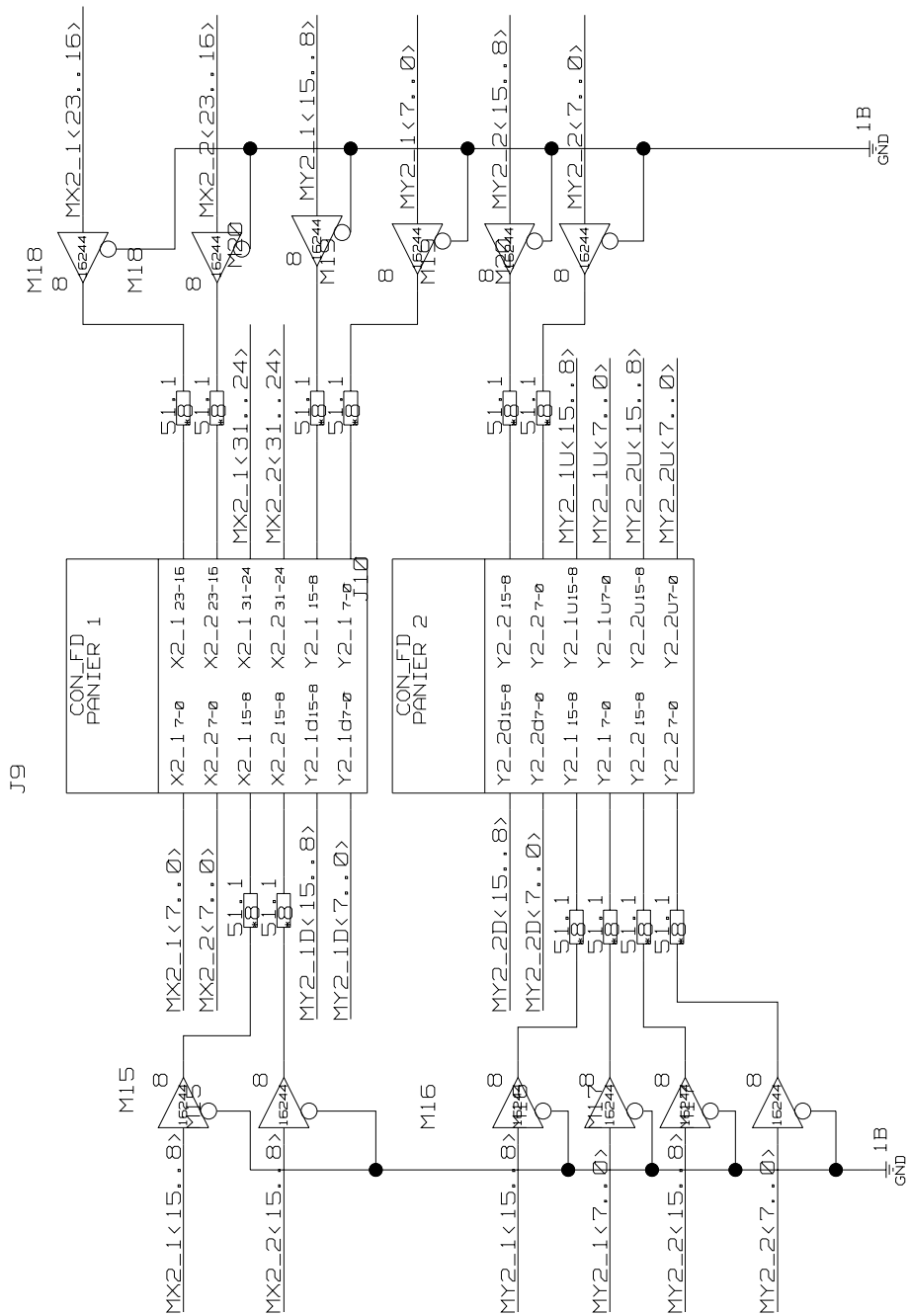

J9

PAGE:6	TRIGGER LOCAL VME 9U PROTO 3	ETUDE: DIMUON TRG	DATE: 23/04/02
SOURCE IMPEDANCE ADAPTATION		LABORATOIRE DE PHYSIQUE CORPUSCULAIRE	
			IN2P3 AUBIERE

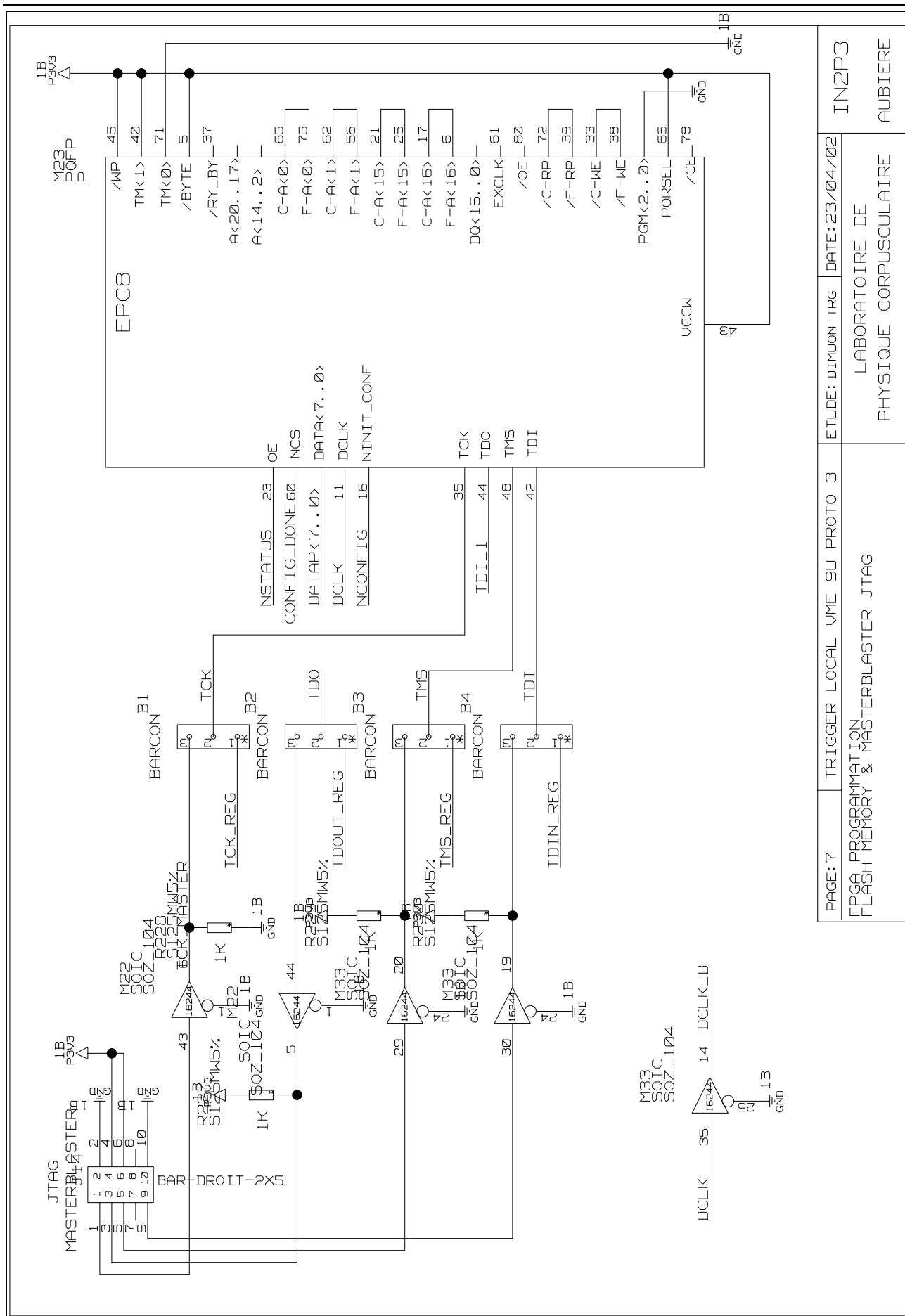

PAGE: 7	TRIGGER LOCAL UME 9U PROTO 3	ETUDE: DIMUON TRG	DATE: 23/04/02	IN2P3
FPGA PROGRAMMATION FLASH MEMORY & MASTERBLASTER JTAG		LABORATOIRE DE PHYSIQUE CORPUSCULAIRE		AUBIERE

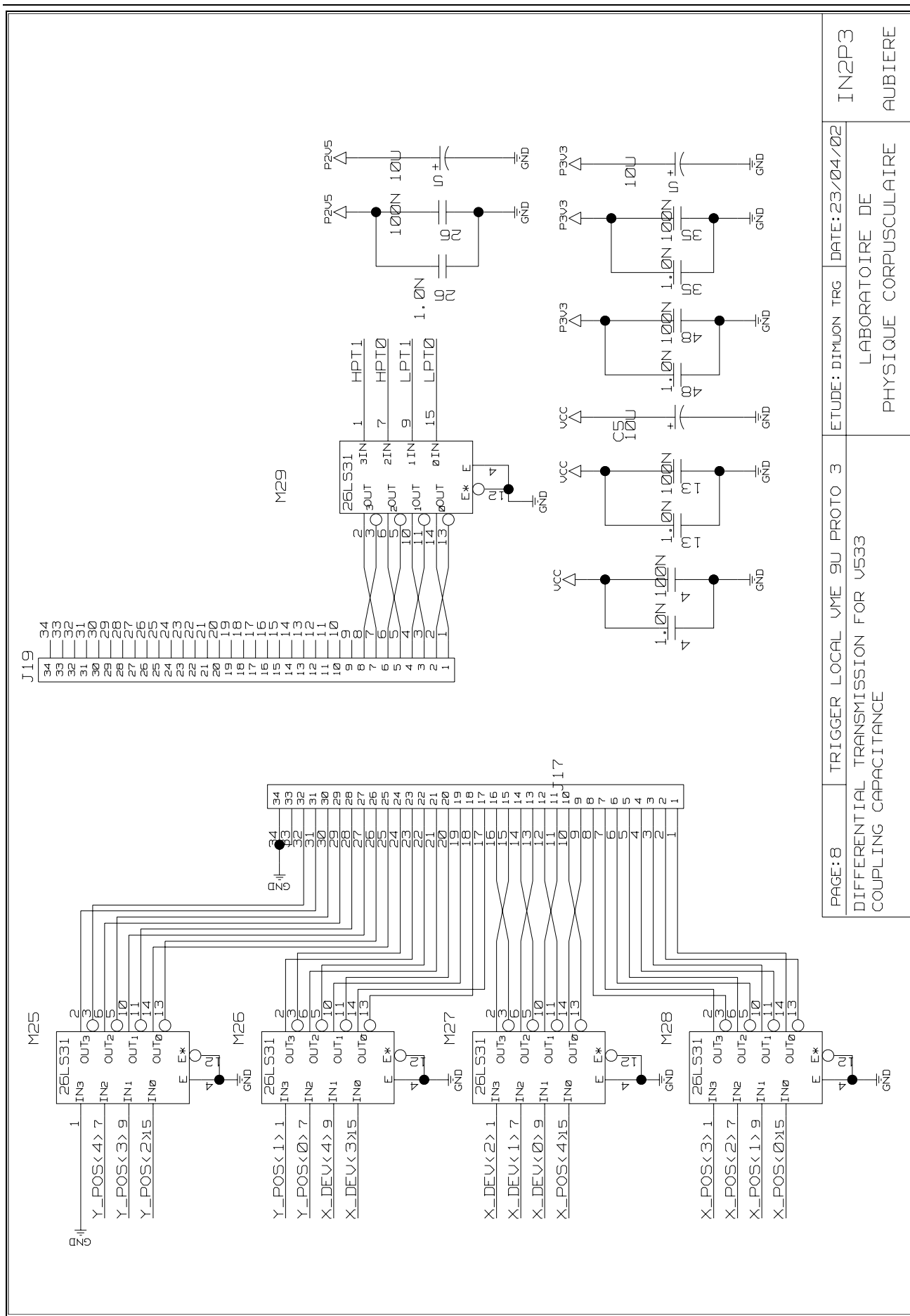

PAGE: 8	TRIGGER LOCAL VME 9U PROTO 3	ETUDE: DIMUON TRG	DATE: 23/04/02	IN2P3
DIFFERENTIAL TRANSMISSION FOR V533		LABORATOIRE DE		AUBIERE
COUPLING CAPACITANCE		PHYSIQUE CORPUSCULAIRE		

ANNEXE 2: SIGNAL TRANSMISSION FROM FEE TO LOCAL TRIGGER

LVDS standard (documentation from National Semiconductor):

The signals from the FEE to the Local trigger are in LVDS standard. The following documentation about LVDS standard has been extracted from the National Semiconductor web site:

<http://www.national.com/appinfo/lvds/>

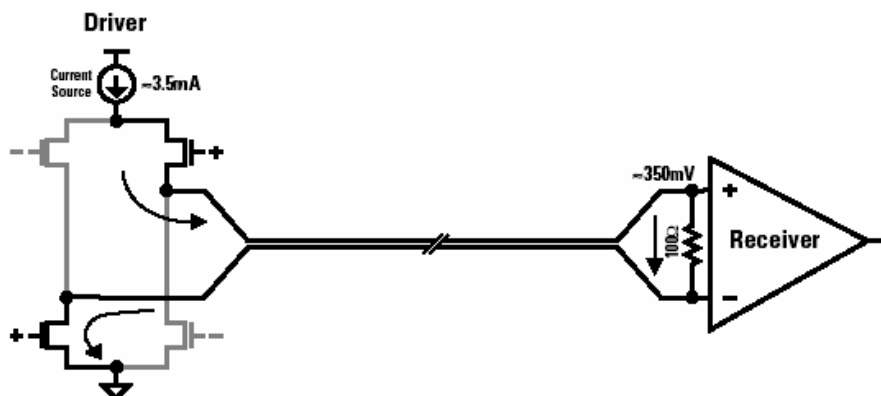

Simplified Diagram of LVDS Driver and Receiver Connected via 100Ω Differential Impedance Media

National's LVDS outputs consist of a current source (nominal 3.5mA) which drives the differential pair line. The basic receiver has high DC input impedance, so the majority of driver current flows across the 100Ω termination resistor generating about 350mV across the receiver inputs. When the driver switches, it changes the direction of current flow across the resistor, thereby creating a valid "one" or "zero" logic state.

Polarity :

With the LVDS receivers used on the Local board, a broken link with the emitter (FEE) corresponds to a HIGH output state. This state must correspond to the status of a non-fired channel.

Therefore, we have adopted the following logic scheme :

LVDS signal in HIGH state (+0.4V) \Rightarrow non-fired channel

LVDS signal in LOW state (-0.4V) \Rightarrow fired channel

This choice is illustrated in the following figure.

Note that, in the Local board, the input signal are inverted just after reception, in the MASKS circuits, in order to work in so-called "positive logic" i.e. a logical 1 corresponds to a fired channel and vice-versa.

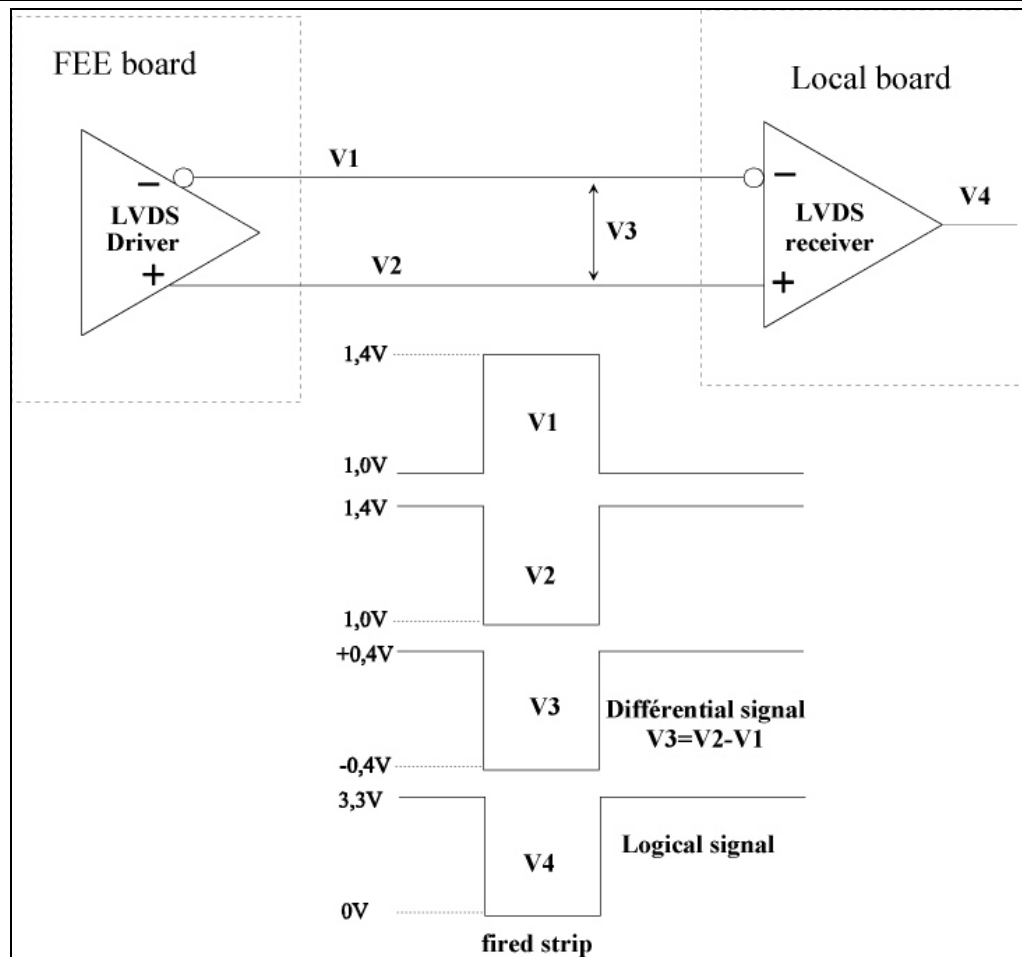

Pin connexions :

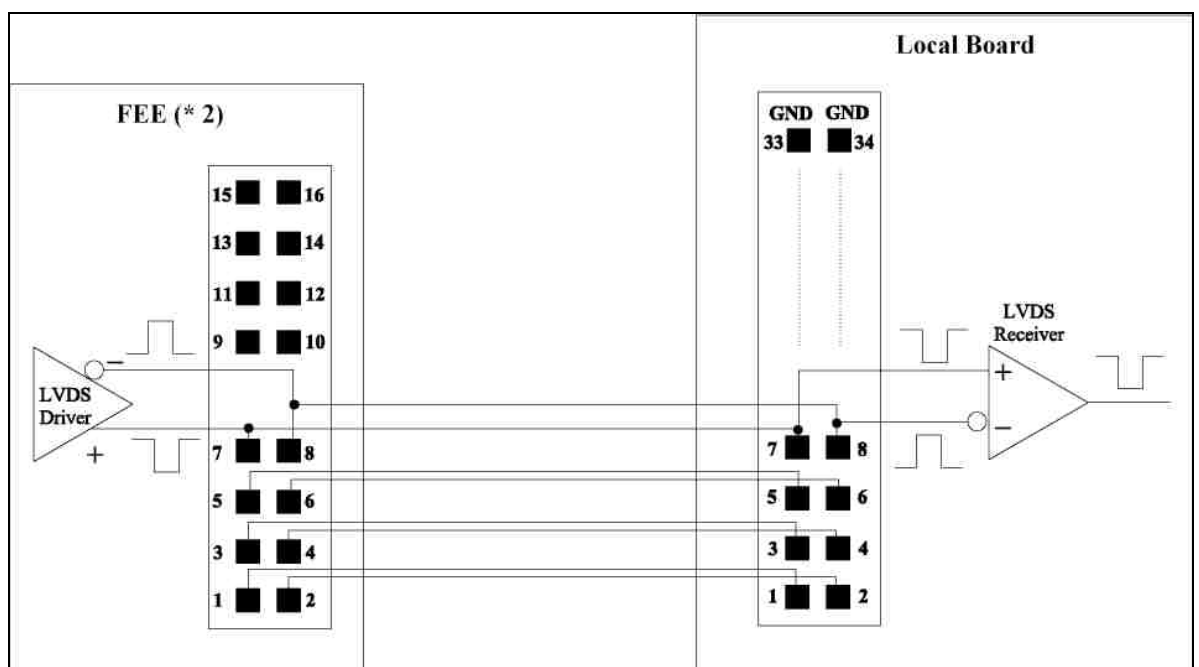

Cables (documentation from National Semiconductor):

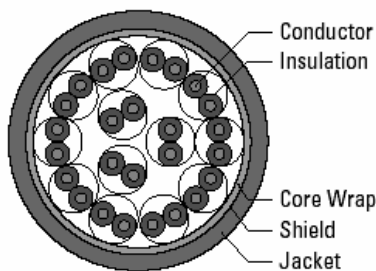

Drawing of Twisted Pair Cable, Cross-Section

Twisted pair cables provide a good, low cost solution with good balance, are flexible, and capable of medium to long runs depending upon the application skew budget. It is offered with an overall shield or with shields around each pair as well as an overall shield. Installing connectors is more difficult due to its construction.

- a) Twisted pair is a good choice for LVDS. Category 3 (CAT3) cable is good for runs up to about 10m, while CAT5 has been used for longer runs.
- b) For the lowest skew, group skew-dependent pairs together (in the same ring to minimize skew between pairs).
- c) Ground and/or terminate unused conductors (do not float).

Grounding scheme :

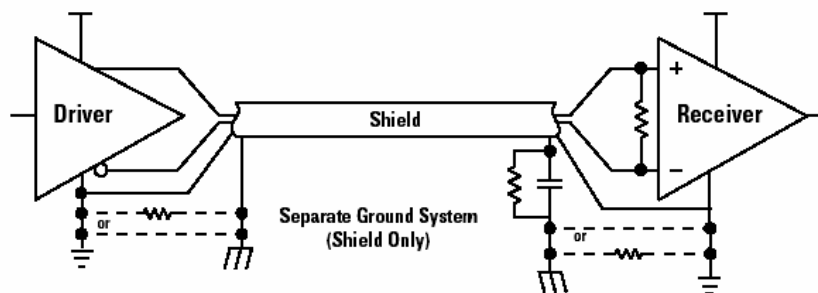

Typical Grounding Scheme

In most applications the grounding system will be common to both the receiver and the driver. The cable shield is connected at one end with a DC connection to the common ground (frame ground). Avoid "pig-tail" (high inductance) ground wiring from the cable. The other end of the shield is typically connected with a capacitor or network of a capacitor and a resistor as shown in the above example. This prevents DC current flow in the shield. In the case where connectors are involved that penetrate the system's enclosure, the cable shield must have a circumferential contact to the connector's conductive back-shell to provide an effective shield and must make good contact.

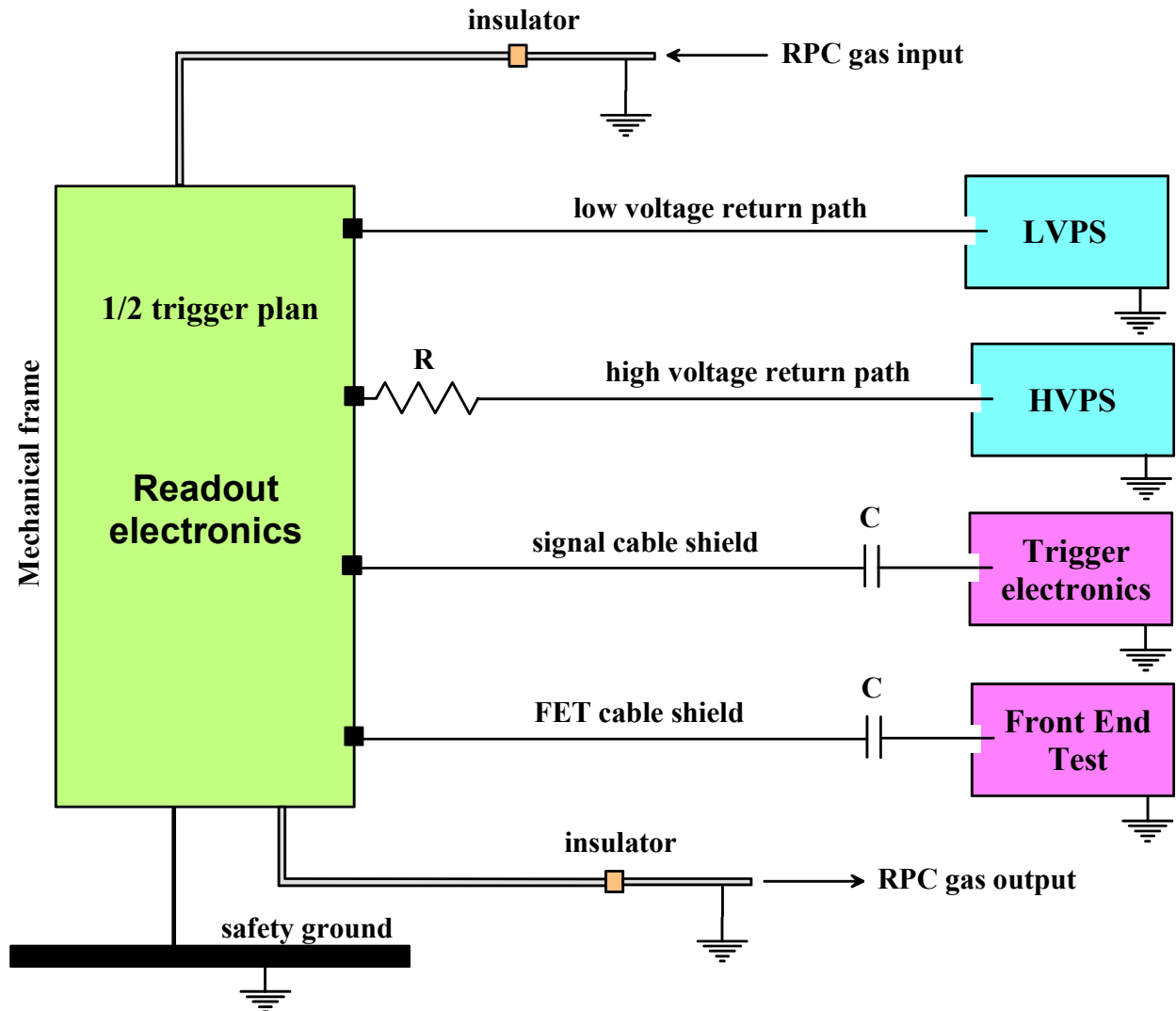

The above scheme shows the general grounding scheme adopted for the dimuon trigger system. The shield of the signal cables will be in practice connected to the pins 33 and 34 of the front panel connectors of the Local board connectors (see Pict. 4-2).

ANNEXE 3: DECLUSTERING, SINGLES AND DOUBLES

DECLUSTERING

1) DOUBLING OF THE BITS

If the input pattern is $CH[n]$ and $CH_{2x}[n]$ is the "doubled" pattern we have then :

$$\begin{cases} CH_{2x}[2n] = CH[n] \\ CH_{2x}[2n+1] = CH[n] \bullet CH[n+1] \end{cases} \quad [1]$$

2) DECLUSTERING $2N-5$

a) Declustered *even* bits:

They are equal to 0 if we have:

0 at indice (-1) and 1 at indice (+1) and (+2) ;

Or 0 at indice (+1) and 1 at indice (-1) and (-2) ;

Therefore if $CH_{dc}[n]$ is the declustered pattern we have :

$$CH_{dc}[2n] = CH_{2x}[2n] \bullet (CH_{2x}[2n+1] + \overline{CH_{2x}[2n-1]} + \overline{CH_{2x}[2n-2]}) \bullet (CH_{2x}[2n-1] + \overline{CH_{2x}[2n+1]} + \overline{CH_{2x}[2n+2]})$$

But with [1] we have :

$$\begin{aligned} & \begin{cases} CH_{2x}[2n] = CH[n] \\ CH_{2x}[2n+1] = CH[n] \bullet CH[n+1] \end{cases} \Leftrightarrow \begin{cases} CH[n] = CH_{2x}[2n] \Leftrightarrow CH[n+1] = CH_{2x}[2(n+1)] \\ CH_{2x}[2n+1] = CH_{2x}[2n] \bullet CH[n+1] \end{cases} \\ & \Leftrightarrow \begin{cases} CH[n+1] = CH_{2x}[2n+2] \\ CH[n] = CH_{2x}[2n] \\ CH_{2x}[2n+1] = CH_{2x}[2n] \bullet CH_{2x}[2n+2] \end{cases} \\ & \Rightarrow \boxed{\begin{cases} CH_{2x}[2n+1] = CH_{2x}[2n] \bullet CH_{2x}[2n+2] \\ CH_{2x}[2n-1] = CH_{2x}[2n-2] \bullet CH_{2x}[2n] \end{cases}} \quad [3] \end{aligned}$$

Therefore in [2] :

$$\begin{aligned} CH_{dc}[2n] = & CH_{2x}[2n] \bullet (CH_{2x}[2n] \bullet CH_{2x}[2n+2] + \overline{CH_{2x}[2n-2]} \bullet \overline{CH_{2x}[2n]} + \overline{CH_{2x}[2n-2]}) \\ & \bullet (CH_{2x}[2n-2] \bullet CH_{2x}[2n] + \overline{CH_{2x}[2n]} \bullet \overline{CH_{2x}[2n+2]} + \overline{CH_{2x}[2n+2]}); \end{aligned}$$

With Morgan's rules :

$$CH_{dc}[2n] = CH_{2x}[2n] \bullet \left(CH_{2x}[2n] \bullet CH_{2x}[2n+2] + \overline{CH_{2x}[2n-2]} + \overline{CH_{2x}[2n]} + \overline{CH_{2x}[2n-2]} \right) \\ \bullet \left(CH_{2x}[2n-2] \bullet CH_{2x}[2n] + \overline{CH_{2x}[2n]} + \overline{CH_{2x}[2n+2]} + \overline{CH_{2x}[2n+2]} \right);$$

$$CH_{dc}[2n] = CH_{2x}[2n] \bullet \left(CH_{2x}[2n] \bullet CH_{2x}[2n+2] + \overline{CH_{2x}[2n-2]} + \overline{CH_{2x}[2n]} \right) \\ \bullet \left(CH_{2x}[2n-2] \bullet CH_{2x}[2n] + \overline{CH_{2x}[2n]} + \overline{CH_{2x}[2n+2]} \right);$$

$$CH_{dc}[2n] = CH_{2x}[2n] \bullet \left(\overline{CH_{2x}[2n]} \bullet CH_{2x}[2n+2] \bullet CH_{2x}[2n-2] + \right. \\ \left. \overline{CH_{2x}[2n-2]} \bullet \overline{CH_{2x}[2n]} + \overline{CH_{2x}[2n-2]} \bullet \overline{CH_{2x}[2n+2]} + \right. \\ \left. \overline{CH_{2x}[2n]} + \overline{CH_{2x}[2n]} \bullet \overline{CH_{2x}[2n+2]} \right)$$

$$CH_{dc}[2n] = CH_{2x}[2n] \bullet \left(CH_{2x}[2n+2] \bullet CH_{2x}[2n-2] + \overline{CH_{2x}[2n-2]} \bullet \overline{CH_{2x}[2n+2]} \right)$$

$$CH_{dc}[2n] = CH_{2x}[2n] \bullet \left(\overline{CH_{2x}[2n+2]} \oplus \overline{CH_{2x}[2n-2]} \right)$$

But with [1] we have :

$$\begin{cases} CH_{2x}[2n-2] = CH[n-1] \\ CH_{2x}[2n] = CH[n] \\ CH_{2x}[2n+2] = CH[n+1] \end{cases}$$

Let's put it in the last result and we obtain :

$$CH_{dc}[2n] = CH[n] \bullet \left(\overline{CH[n+1]} \oplus \overline{CH[n-1]} \right)$$

a) Declustered odd bits :

They are equal to if we have : 0 at indice (-2) and 1 at indice (+1) and (+2)

Or 0 at indice (+2) and 1 at indice (-1) and (-2) ;

Therefore

$$CH_{dc}[2n+1] = CH_{2x}[2n+1] \bullet \left(CH_{2x}[2n-1] + \overline{CH_{2x}[2n+2]} + \overline{CH_{2x}[2n+3]} \right) \bullet \left(CH_{2x}[2n+3] + \overline{CH_{2x}[2n]} + \overline{CH_{2x}[2n-1]} \right)$$

But with [1] we have :

$$\begin{cases} CH_{2x}[2n+3] = CH_{2x}[2n+2] \bullet CH_{2x}[2n+4] \Rightarrow \langle CH_{2x}[2n+3] = 1 \Rightarrow CH_{2x}[2n+2] = 1 \rangle \\ CH_{2x}[2n-1] = CH_{2x}[2n-2] \bullet CH_{2x}[2n] \Rightarrow \langle CH_{2x}[2n-1] = 1 \Rightarrow CH_{2x}[2n] = 1 \rangle \end{cases}$$

$$\Rightarrow \begin{cases} CH_{2x}[2n+3] = 1 \Rightarrow \overline{CH_{2x}[2n+2]} + \overline{CH_{2x}[2n+3]} = 0 \\ CH_{2x}[2n-1] = 1 \Rightarrow \overline{CH_{2x}[2n]} + \overline{CH_{2x}[2n-1]} = 0 \end{cases}$$

and

$$\Rightarrow \begin{cases} CH_{2x}[2n+3] = 0 \Rightarrow \overline{CH_{2x}[2n+2]} + \overline{CH_{2x}[2n+3]} = 1 \quad \forall CH_{2x}[2n+2] \\ CH_{2x}[2n-1] = 0 \Rightarrow \overline{CH_{2x}[2n]} + \overline{CH_{2x}[2n-1]} = 1 \quad \forall CH_{2x}[2n] \end{cases}$$

leading to

$$\begin{cases} \overline{CH_{2x}[2n+2]} + \overline{CH_{2x}[2n+3]} = \overline{CH_{2x}[2n+3]} \\ \overline{CH_{2x}[2n]} + \overline{CH_{2x}[2n-1]} = \overline{CH_{2x}[2n-1]} \end{cases}$$

therefore

$$CH_{dc}[2n+1] = CH_{2x}[2n+1] \bullet \left(CH_{2x}[2n-1] + \overline{CH_{2x}[2n+3]} \right) \bullet \left(CH_{2x}[2n+3] + \overline{CH_{2x}[2n-1]} \right)$$

But with [1] we have :

$$\begin{cases} CH_{2x}[2n+1] = CH[n] \bullet CH[n+1] \\ CH_{2x}[2n-1] = CH[n-1] \bullet CH[n] \\ CH_{2x}[2n+3] = CH[n+1] \bullet CH[n+2] \end{cases}$$

Therefore:

$$CH_{dc}[2n+1] = CH[n] \bullet CH[n+1] \bullet (CH[n-1] \bullet CH[n] + \overline{CH[n+1]} \bullet \overline{CH[n+2]}) \bullet (CH[n+1] \bullet CH[n+2] + \overline{CH[n-1]} \bullet \overline{CH[n]})$$

With Morgan's rules:

$$CH_{dc}[2n+1] = CH[n] \bullet CH[n+1] \bullet (CH[n-1] \bullet CH[n] + \overline{CH[n+1]} + \overline{CH[n+2]}) \bullet (CH[n+1] \bullet CH[n+2] + \overline{CH[n-1]} + \overline{CH[n]})$$

$$CH_{dc}[2n+1] = CH[n] \bullet CH[n+1] \bullet (CH[n-1] \bullet CH[n] \bullet CH[n+1] \bullet CH[n+2] + (\overline{CH[n+1]} + \overline{CH[n+2]}) \bullet (\overline{CH[n-1]} + \overline{CH[n]}))$$

$$CH_{dc}[2n+1] = CH[n-1] \bullet CH[n] \bullet CH[n+1] \bullet CH[n+2] + CH[n] \bullet CH[n+1] \bullet \overline{CH[n-1]} \bullet \overline{CH[n+2]}$$

$$CH_{dc}[2n+1] = CH[n] \bullet CH[n+1] \bullet (CH[n-1] \bullet CH[n+2] + \overline{CH[n-1]} \bullet \overline{CH[n+2]})$$

$$CH_{dc}[2n+1] = CH[n] \bullet CH[n+1] \bullet (\overline{CH[n-1]} \oplus \overline{CH[n+2]})$$

SINGLES AND DOUBLES COMPUTATION

With the declustering step the number of bits to deal with has been doubled (more precisely 2n-1). The mini-road is of ± 2 declustered bits between the two planes of a trigger station.

So we have a « double » hit at position m when the bit m of the first plane is fired and at least one strip of the second plane at position m+2, m+1, m, m-1, m-2.

Therefore, if CH1_{dc} and CH2_{dc} are respectively the declustered patterns of the first and second plane and if DBL is the bit pattern representing the double hits :

$$DBL[m] = CH1_{dc}[m] \bullet (CH2_{dc}[m+2] + CH2_{dc}[m+1] + CH2_{dc}[m] + CH2_{dc}[m-1] + CH2_{dc}[m-2])$$

According to the declustering calculation we have (for the even bits):

$$DBL[2n] = CH1_{dc}[2n] \bullet (CH2_{dc}[2n+2] + CH2_{dc}[2n+1] + CH2_{dc}[2n] + CH2_{dc}[2n-1] + CH2_{dc}[2n-2])$$

⇕

A

⇕

B

$$A = CH1[n] \bullet (\overline{CH1[n+1]} \oplus \overline{CH1[n-1]})$$

$$\begin{aligned} B = & CH2[n+1] \bullet (CH2[n+2] \bullet CH2[n] + \overline{CH2[n+2]} \bullet \overline{CH2[n]}) + \\ & CH2[n] \bullet CH2[n+1] \bullet (CH2[n-1] \bullet CH2[n+2] + \overline{CH2[n-1]} \bullet \overline{CH2[n+2]}) + \\ & CH2[n] \bullet (CH2[n+1] \bullet CH2[n-1] + \overline{CH2[n+1]} \bullet \overline{CH2[n-1]}) + \\ & CH2[n-1] \bullet CH2[n] \bullet (CH2[n-2] \bullet CH2[n+1] + \overline{CH2[n-2]} \bullet \overline{CH2[n+1]}) + \\ & CH2[n-1] \bullet (CH2[n-2] \bullet CH2[n] + \overline{CH2[n-2]} \bullet \overline{CH2[n]}) \end{aligned}$$

$$\begin{aligned} B = & CH2[n+1] \bullet (\overline{CH2[n+2]} \oplus \overline{CH2[n]}) + CH2[n] \bullet CH2[n+1] \bullet (\overline{CH2[n-1]} \oplus \overline{CH2[n+2]}) + \\ & CH2[n] \bullet (\overline{CH2[n+1]} \oplus \overline{CH2[n-1]}) + CH2[n-1] \bullet CH2[n] \bullet (\overline{CH2[n-2]} \oplus \overline{CH2[n+1]}) + \\ & CH2[n-1] \bullet (\overline{CH2[n]} \oplus \overline{CH2[n-2]}) \end{aligned}$$

If we calculate the previous expression we obtain the sum of 10 terms, each term being a logic AND of at least three terms. In the blue table following the 10 terms are depicted, showing only the indices. With the formulas in the green table we'll be able to simplify the expression :

$$\begin{array}{l}
 A \bullet B + A = A(B+1) = A \qquad A + \bar{A} \bullet B = A + B \\
 \bar{A} \bullet \bar{B} + A = A + \bar{B} \qquad \bar{A} + A \bullet B = \bar{A} + B \\
 A + \bar{A} = 1
 \end{array}$$

term n°									
1	2	3	4	5	6	7	8	9	10
						$n-2$	$\overline{n-2}$	$n-2$	$\overline{n-2}$
		$n-1$	$\overline{n-1}$	$n-1$	$\overline{n-1}$	$n-1$	$n-1$	$n-1$	$n-1$
n	\bar{n}	n	n	n	n	n	n	n	\bar{n}
$n+1$	$n+1$	$n+1$	$n+1$	$n+1$	$\overline{n+1}$	$n+1$	$\overline{n+1}$		
$n+2$	$\overline{n+2}$	$n+2$	$\overline{n+2}$						

$$\begin{aligned}
 (7+9) &= CH2[n-2] \bullet CH2[n-1] \bullet CH2[n] \bullet CH2[n+1] + CH2[n-2] \bullet CH2[n-1] \bullet CH2[n] \\
 (7+9) &= CH2[n-2] \bullet CH2[n-1] \bullet CH2[n] \\
 (3+5) &= CH2[n-1] \bullet CH2[n] \bullet CH2[n+1] \bullet CH2[n+2] + CH2[n-1] \bullet CH2[n] \bullet CH2[n+1] \\
 (3+5) &= CH2[n-1] \bullet CH2[n] \bullet CH2[n+1]
 \end{aligned}$$

term n°							
1	2	3+5	4	6	7+9	8	10
					$n-2$	$\overline{n-2}$	$\overline{n-2}$
		$n-1$	$\overline{n-1}$	$\overline{n-1}$	$n-1$	$n-1$	$n-1$
n	\bar{n}	n	n	n	n	n	\bar{n}
$n+1$	$n+1$	$n+1$	$n+1$	$\overline{n+1}$		$\overline{n+1}$	
$n+2$	$\overline{n+2}$		$\overline{n+2}$				

Intermediate result :

$$\begin{aligned}
 ((3+5)+4) &= CH2[n] \bullet CH2[n+1] \bullet (CH2[n-1] \bullet CH2[n+2] + CH2[n-1]) (\bar{A} \bullet \bar{B} + A = A + \bar{B}) \\
 ((3+5)+4) &= CH2[n] \bullet CH2[n+1] \bullet (CH2[n-1] + CH2[n+2]) \\
 (((3+5)+4)+2) &= CH2[n] \bullet CH2[n+1] \bullet (CH2[n-1] + CH2[n+2]) + CH2[n] \bullet CH2[n+1] \bullet CH2[n+2] \\
 (((3+5)+4)+2) &= CH2[n-1] \bullet CH2[n] \bullet CH2[n+1] + CH2[n] \bullet CH2[n+1] \bullet CH2[n+2] + \\
 &\quad CH2[n] \bullet CH2[n+1] \bullet CH2[n+2] \\
 (((3+5)+4)+2) &= CH2[n-1] \bullet CH2[n] \bullet CH2[n+1] + CH2[n+1] \bullet CH2[n+2] \bullet \underbrace{(CH2[n] + CH2[n])}_{=1} \\
 (((3+5)+4)+2) &= CH2[n-1] \bullet CH2[n] \bullet CH2[n+1] + CH2[n+1] \bullet CH2[n+2]
 \end{aligned}$$

$$\begin{aligned}
 ((7+9)+8) &= CH2[n-1] \cdot CH2[n] \cdot (\overline{CH2[n-2]} \cdot \overline{CH2[n+1]} + CH2[n-2]) \\
 ((7+9)+8) &= CH2[n-1] \cdot CH2[n] \cdot (CH2[n-2] + \overline{CH2[n+1]}) \\
 (((7+9)+8)+6) &= CH2[n-1] \cdot CH2[n] \cdot (CH2[n-2] + \overline{CH2[n+1]}) + \overline{CH2[n-1]} \cdot CH2[n] \cdot \overline{CH2[n+1]} \\
 (((7+9)+8)+6) &= CH2[n-1] \cdot CH2[n] \cdot CH2[n-2] + CH2[n-1] \cdot CH2[n] \cdot \overline{CH2[n+1]} + \\
 &\quad \overline{CH2[n-1]} \cdot CH2[n] \cdot \overline{CH2[n+1]} \\
 (((7+9)+8)+6) &= CH2[n-2] \cdot CH2[n-1] \cdot CH2[n] + CH2[n] \cdot \overline{CH2[n+1]} \cdot \underbrace{(CH2[n-1] + \overline{CH2[n-1]})}_{=1} \\
 (((7+9)+8)+6) &= CH2[n-2] \cdot CH2[n-1] \cdot CH2[n] + CH2[n] \cdot \overline{CH2[n+1]}
 \end{aligned}$$

$$\begin{aligned}
 B &= CH2[n] \cdot CH2[n+1] \cdot CH2[n+2] + CH2[n-1] \cdot CH2[n] \cdot CH2[n+1] + CH2[n+1] \cdot \overline{CH2[n+2]} + \\
 &\quad CH2[n-2] \cdot CH2[n-1] \cdot CH2[n] + CH2[n] \cdot \overline{CH2[n+1]} + \overline{CH2[n-2]} \cdot CH2[n-1] \cdot \overline{CH2[n]}
 \end{aligned}$$

$$\begin{aligned}
 B &= CH2[n] \cdot (CH2[n-1] \cdot CH2[n+1] + \overline{CH2[n+1]}) + CH2[n+1] \cdot (CH2[n] \cdot CH2[n+2] + \overline{CH2[n+2]}) + \\
 &\quad CH2[n-2] \cdot CH2[n-1] \cdot CH2[n] + \overline{CH2[n-2]} \cdot CH2[n-1] \cdot \overline{CH2[n]}
 \end{aligned}$$

$$\begin{aligned}
 B &= CH2[n] \cdot (CH2[n-1] + \overline{CH2[n+1]}) + CH2[n+1] \cdot (CH2[n] + \overline{CH2[n+2]}) + \\
 &\quad CH2[n-2] \cdot CH2[n-1] \cdot CH2[n] + \overline{CH2[n-2]} \cdot CH2[n-1] \cdot \overline{CH2[n]} \quad (\overline{A} + A \cdot B = \overline{A} + B)
 \end{aligned}$$

$$\begin{aligned}
 B &= CH2[n] \cdot CH2[n-1] + CH2[n] \cdot \overline{CH2[n+1]} + CH2[n] \cdot CH2[n+1] + CH2[n+1] \cdot \overline{CH2[n+2]} + \\
 &\quad CH2[n-2] \cdot CH2[n-1] \cdot CH2[n] + \overline{CH2[n-2]} \cdot CH2[n-1] \cdot \overline{CH2[n]}
 \end{aligned}$$

$$\begin{aligned}
 B &= CH2[n] \cdot CH2[n-1] + CH2[n] \cdot \underbrace{(\overline{CH2[n+1]} + CH2[n+1])}_{=1} + CH2[n+1] \cdot \overline{CH2[n+2]} + \\
 &\quad \underbrace{CH2[n-2] \cdot CH2[n-1] \cdot CH2[n]}_{=CH2[n]} + \overline{CH2[n-2]} \cdot CH2[n-1] \cdot \overline{CH2[n]}
 \end{aligned}$$

$$\begin{aligned}
 B &= CH2[n] + CH2[n+1] \cdot \overline{CH2[n+2]} + CH2[n-2] \cdot CH2[n-1] \cdot CH2[n] + \overline{CH2[n-2]} \cdot CH2[n-1] \cdot \overline{CH2[n]} \\
 B &= CH2[n] \cdot \underbrace{(1 + CH2[n-2] \cdot CH2[n-1])}_{=1} + CH2[n+1] \cdot \overline{CH2[n+2]} + \overline{CH2[n-2]} \cdot CH2[n-1] \cdot \overline{CH2[n]}
 \end{aligned}$$

$$B = CH2[n] + \overline{CH2[n-2]} \cdot CH2[n-1] \cdot \overline{CH2[n]} + CH2[n+1] \cdot \overline{CH2[n+2]} \quad (A + \overline{A} \cdot B = A + B)$$

$$B = CH2[n] + \overline{CH2[n-2]} \cdot CH2[n-1] + CH2[n+1] \cdot \overline{CH2[n+2]}$$

Therefore :

$$DBL[2n] = CH1[n] \cdot (\overline{CH1[n+1]} \oplus CH1[n-1]) \cdot \left(\begin{array}{l} CH2[n] + \\ \overline{CH2[n-2]} \cdot CH2[n-1] + \\ CH2[n+1] \cdot \overline{CH2[n+2]} \end{array} \right)$$

For the **odd** bits:

$$\begin{array}{ccc}
 DBL[2n+1] = CH1_{dc}[2n+1] \bullet (CH2_{dc}[2n+3] + CH2_{dc}[2n+2] + CH2_{dc}[2n+1] + CH2_{dc}[2n] + CH2_{dc}[2n-1]) & & \\
 \Downarrow & & \Downarrow \\
 A & & B
 \end{array}$$

$$\begin{aligned}
 A &= CH1[n] \bullet CH1[n+1] \bullet (\overline{CH1[n-1]} \oplus CH1[n+2]) \\
 B &= CH2[n+1] \bullet CH2[n+2] \bullet (\overline{CH2[n]} \oplus CH2[n+3]) + CH2[n+1] \bullet (\overline{CH2[n]} \oplus CH2[n+2]) + \\
 &\quad CH2[n] \bullet CH2[n+1] \bullet (\overline{CH2[n-1]} \oplus CH2[n+2]) + CH2[n] \bullet (\overline{CH2[n-1]} \oplus CH2[n+1]) + \\
 &\quad CH2[n-1] \bullet CH2[n] \bullet (\overline{CH2[n-2]} \oplus CH2[n+1])
 \end{aligned}$$

$$\begin{aligned}
 B &= CH2[n+1] \bullet CH2[n+2] \bullet (CH2[n] \bullet CH2[n+3] + \overline{CH2[n]} \bullet \overline{CH2[n+3]}) + \\
 &\quad CH2[n+1] \bullet (CH2[n] \bullet CH2[n+2] + \overline{CH2[n]} \bullet \overline{CH2[n+2]}) + \\
 &\quad CH2[n] \bullet CH2[n+1] \bullet (CH2[n-1] \bullet CH2[n+2] + \overline{CH2[n-1]} \bullet \overline{CH2[n+2]}) + \\
 &\quad CH2[n] \bullet (CH2[n-1] \bullet CH2[n+1] + \overline{CH2[n-1]} \bullet \overline{CH2[n+1]}) + \\
 &\quad CH2[n-1] \bullet CH2[n] \bullet (CH2[n-2] \bullet CH2[n+1] + \overline{CH2[n-2]} \bullet \overline{CH2[n+1]})
 \end{aligned}$$

If we calculate the previous expression we obtain the sum of 10 terms, each term being a logic AND of at least three terms. In the blue table following the 10 terms are depicted, showing only the indices:

term n°									
1	2	3	4	5	6	7	8	9	10
								$n-2$	$\overline{n-2}$
				$n-1$	$\overline{n-1}$	$n-1$	$\overline{n-1}$	$n-1$	$n-1$
n	\overline{n}	n	\overline{n}	n	n	n	n	n	n
$n+1$	$n+1$	$n+1$	$\overline{n+1}$	$n+1$	$n+1$	$n+1$	$\overline{n+1}$	$n+1$	$\overline{n+1}$
$n+2$	$n+2$	$n+2$	$\overline{n+2}$	$n+2$	$\overline{n+2}$				
$n+3$	$\overline{n+3}$								

$$(3+5) = CH2[n] \bullet CH2[n+1] \bullet CH2[n+2] + CH2[n-1] \bullet CH2[n] \bullet CH2[n+1] \bullet CH2[n+2]$$

$$(3+5) = CH2[n] \bullet CH2[n+1] \bullet CH2[n+2] \bullet \underbrace{(1 + CH2[n-1])}_{=1}$$

$$(3+5) = CH2[n] \bullet CH2[n+1] \bullet CH2[n+2]$$

$$((3+5)+6) = CH2[n] \bullet CH2[n+1] \bullet CH2[n+2] + \overline{CH2[n-1]} \bullet CH2[n] \bullet CH2[n+1] \bullet \overline{CH2[n+2]}$$

$$((3+5)+6) = CH2[n] \bullet CH2[n+1] \bullet (CH2[n+2] + \overline{CH2[n-1]} \bullet \overline{CH2[n+2]})$$

$$((3+5)+6) = CH2[n] \bullet CH2[n+1] \bullet (CH2[n+2] + \overline{CH2[n-1]}) \quad (A + \overline{A} \bullet \overline{B} = A + \overline{B})$$

$$((3+5)+6) = CH2[n] \bullet CH2[n+1] \bullet CH2[n+2] + \overline{CH2[n-1]} \bullet CH2[n] \bullet CH2[n+1]$$

$$(((3+5)+6)+7) = CH2[n] \bullet CH2[n+1] \bullet CH2[n+2] + \overline{CH2[n-1]} \bullet CH2[n] \bullet CH2[n+1] + CH2[n-1] \bullet CH2[n] \bullet CH2[n+1]$$

$$(((3+5)+6)+7) = CH2[n] \bullet CH2[n+1] \bullet CH2[n+2] + CH2[n] \bullet CH2[n+1] \bullet \underbrace{(\overline{CH2[n-1]} + CH2[n-1])}_{=1}$$

$$(((3+5)+6)+7) = CH2[n] \bullet CH2[n+1] \bullet CH2[n+2] + CH2[n] \bullet CH2[n+1]$$

$$(((3+5)+6)+7) = CH2[n] \bullet CH2[n+1] \bullet \underbrace{(1 + CH2[n+2])}_{=1}$$

$$(((3+5)+6)+7) = CH2[n] \bullet CH2[n+1]$$

$$((((3+5)+6)+7)+1) = CH2[n] \bullet CH2[n+1] + CH2[n] \bullet CH2[n+1] \bullet CH2[n+2] \bullet CH2[n+3]$$

$$((((3+5)+6)+7)+1) = CH2[n] \bullet CH2[n+1] \bullet \underbrace{(1 + CH2[n+2])}_{=1} \bullet CH2[n+3]$$

$$((((3+5)+6)+7)+1) = CH2[n] \bullet CH2[n+1]$$

$$((((((3+5)+6)+7)+1)+9) = CH2[n] \bullet CH2[n+1] + CH2[n-2] \bullet CH2[n-1] \bullet CH2[n] \bullet CH2[n+1]$$

$$((((((3+5)+6)+7)+1)+9) = CH2[n] \bullet CH2[n+1] \bullet \underbrace{(1 + CH2[n-2])}_{=1} \bullet CH2[n-1]$$

$$((((((3+5)+6)+7)+1)+9) = CH2[n] \bullet CH2[n+1]$$

$$B = CH2[n] \bullet CH2[n+1] + \overline{CH2[n]} \bullet CH2[n+1] \bullet CH2[n+2] \bullet \overline{CH2[n+3]} + \overline{CH2[n]} \bullet CH2[n+1] \bullet \overline{CH2[n+2]} + \overline{CH2[n-1]} \bullet CH2[n] \bullet \overline{CH2[n+1]} + \overline{CH2[n-2]} \bullet CH2[n-1] \bullet CH2[n] \bullet \overline{CH2[n+1]}$$

$$B = CH2[n] \bullet CH2[n+1] + \overline{CH2[n]} \bullet CH2[n+1] \bullet (\overline{CH2[n+2]} + CH2[n+2] \bullet \overline{CH2[n+3]}) + CH2[n] \bullet \overline{CH2[n+1]} \bullet (\overline{CH2[n-1]} + \overline{CH2[n-2]} \bullet CH2[n-1])$$

$$B = CH2[n] \bullet CH2[n+1] + \overline{CH2[n]} \bullet CH2[n+1] \bullet (\overline{CH2[n+2]} + \overline{CH2[n+3]}) + CH2[n] \bullet \overline{CH2[n+1]} \bullet (\overline{CH2[n-1]} + \overline{CH2[n-2]})$$

$$B = CH2[n] \bullet (CH2[n+1] + \overline{CH2[n-1]} \bullet \overline{CH2[n+1]} + \overline{CH2[n+1]} \bullet \overline{CH2[n-2]}) + \overline{CH2[n]} \bullet CH2[n+1] \bullet (\overline{CH2[n+2]} + \overline{CH2[n+3]})$$

$$B = CH2[n] \bullet (CH2[n+1] + \overline{CH2[n-1]} + \overline{CH2[n+1]} \bullet \overline{CH2[n-2]}) + \overline{CH2[n]} \bullet CH2[n+1] \bullet (\overline{CH2[n+2]} + \overline{CH2[n+3]})$$

$$B = CH2[n] \bullet (CH2[n+1] + \overline{CH2[n-1]} + \overline{CH2[n-2]}) + \overline{CH2[n]} \bullet CH2[n+1] \bullet (\overline{CH2[n+2]} + \overline{CH2[n+3]})$$

$$B = CH2[n] \bullet (\overline{CH2[n-1]} + \overline{CH2[n-2]}) + CH2[n+1] \bullet (CH2[n] + \overline{CH2[n]} \bullet \overline{CH2[n+2]} + \overline{CH2[n]} \bullet \overline{CH2[n+3]})$$

$$B = CH2[n] \bullet (\overline{CH2[n-1]} + \overline{CH2[n-2]}) + CH2[n+1] \bullet (CH2[n] + \overline{CH2[n+2]} + \overline{CH2[n]} \bullet \overline{CH2[n+3]})$$

Therefore :

$$DBL[2n+1] = CH1[n] \bullet CH1[n+1] \bullet (\overline{CH1[n-1]} \oplus \overline{CH1[n+2]}) \bullet \left(\begin{array}{l} CH2[n] \bullet (\overline{CH2[n-1]} + \overline{CH2[n-2]}) + \\ CH2[n+1] \bullet (CH2[n] + \overline{CH2[n+2]} + \overline{CH2[n+3]}) \end{array} \right)$$

The single hits calculation is made simpler by the DS reduction (no need to check if a double hit exists at the same position of the single one) and if **SGL** is the bit pattern representing the single hits we have :

$$SPL[m] = CH1_{dc}[m] + CH2_{dc}[m]$$

$$SPL[2n + 1] = CH1[n] \cdot CH1[n + 1] \cdot (\overline{CH1[n - 1] \oplus CH1[n + 2]}) +$$

$$CH2[n] \cdot CH2[n + 1] \cdot (\overline{CH2[n - 1] \oplus CH2[n + 2]})$$

$$SPL[2n] = CH1[n] \cdot (\overline{CH1[n - 1] \oplus CH1[n + 1]}) +$$

$$CH2[n] \cdot (\overline{CH2[n - 1] \oplus CH2[n + 1]})$$

ANNEXE 4: LOCAL BOARD CONFIGURATION (SEE §2.4.6)

Board 1 Board num RC1L1B1 CRATE 1 R Slot = 1

X1input1 = 1RC1L1X1	X1input2 = 1RC1L1X2
X2input1 = 2RC1L1X1	X2input2 = 2RC1L1X2
X3input1 = 3RC1L1X1	X3input2 = 3RC1L1X2
X4input1 = 4RC1L1X1	X4input2 = 4RC1L1X2
Y1input1 = 1RC1L1Y1	Y1input2 = NONE
Y2input1 = 2RC1L1Y1	Y2input2 = NONE
Y3input1 = 3RC1L1Y1	Y3input2 = NONE
Y4input1 = 4RC1L1Y1	Y4input2 = NONE

transv. conn. NONE
 Switch(RC1L1B1) = 011-10-1-0-100

Board 2 Board num RC1L2B1 CRATE 1 R Slot = 2

X1input1 = 1RC1L2X1	X1input2 = 1RC1L2X2
X2input1 = 2RC1L2X1	X2input2 = 2RC1L2X2
X3input1 = 3RC1L2X1	X3input2 = 3RC1L2X2
X4input1 = 4RC1L2X1	X4input2 = 4RC1L2X2
Y1input1 = 1RC1L2Y1	Y1input2 = NONE
Y2input1 = 2RC1L2Y1	Y2input2 = NONE
Y3input1 = 3RC1L2Y1	Y3input2 = NONE
Y4input1 = 4RC1L2Y1	Y4input2 = NONE

transv. conn. : M
 Switch(RC1L2B1) = 111-01-1-0-000

Board 3 Board num RC1L2B2 CRATE 1 R Slot = 3

X1input1 = 1RC1L2X3	X1input2 = 1RC1L2X4
X2input1 = 2RC1L2X3	X2input2 = 2RC1L2X4
X3input1 = 3RC1L2X3	X3input2 = 3RC1L2X4
X4input1 = 4RC1L2X3	X4input2 = 4RC1L2X4
Y1input1 = NONE	Y1input2 = NONE
Y2input1 = NONE	Y2input2 = NONE
Y3input1 = NONE	Y3input2 = NONE
Y4input1 = NONE	Y4input2 = NONE

transv. conn. : F
 Switch(RC1L2B2) = 110-10-0-0-000

Board 4 Board num RC1L3B1 CRATE 1 R Slot = 4

X1input1 = 1RC1L3X1	X1input2 = 1RC1L3X2
X2input1 = 2RC1L3X1	X2input2 = 2RC1L3X2
X3input1 = 3RC1L3X1	X3input2 = 3RC1L3X2
X4input1 = 4RC1L3X1	X4input2 = 4RC1L3X2
Y1input1 = 1RC1L3Y1	Y1input2 = 1RC1L3Y2
Y2input1 = 2RC1L3Y1	Y2input2 = 2RC1L3Y2
Y3input1 = 3RC1L3Y1	Y3input2 = 3RC1L3Y2
Y4input1 = 4RC1L3Y1	Y4input2 = 4RC1L3Y2

transv. conn. : M
 Switch(RC1L3B1) = 100-01-1-0-000

Board 5 Board num RC1L3B2 CRATE 1 R Slot = 5

X1input1 = 1RC1L3X3	X1input2 = 1RC1L3X4
X2input1 = 2RC1L3X3	X2input2 = 2RC1L3X4
X3input1 = 3RC1L3X3	X3input2 = 3RC1L3X4
X4input1 = 4RC1L3X3	X4input2 = 4RC1L3X4
Y1input1 = NONE	Y1input2 = NONE
Y2input1 = NONE	Y2input2 = NONE
Y3input1 = NONE	Y3input2 = NONE
Y4input1 = NONE	Y4input2 = NONE

transv. conn. : F
 Switch(RC1L3B2) = 000-10-0-0-000

Board 6 Board num RC1L4B1 CRATE 1 R Slot = 6

X1input1 = 1RC1L4X1	X1input2 = 1RC1L4X2
X2input1 = 2RC1L4X1	X2input2 = 2RC1L4X2
X3input1 = 3RC1L4X1	X3input2 = 3RC1L4X2
X4input1 = 4RC1L4X1	X4input2 = 4RC1L4X2
Y1input1 = 1RC1L4Y1	Y1input2 = 1RC1L4Y2
Y2input1 = 2RC1L4Y1	Y2input2 = 2RC1L4Y2
Y3input1 = 3RC1L4Y1	Y3input2 = 3RC1L4Y2
Y4input1 = 4RC1L4Y1	Y4input2 = 4RC1L4Y2

transv. conn. : M
 Switch(RC1L4B1) = 000-01-1-0-000

Board 7 Board num RC1L4B2 CRATE 1 R Slot = 7

X1input1 = 1RC1L4X3	X1input2 = 1RC1L4X4
X2input1 = 2RC1L4X3	X2input2 = 2RC1L4X4
X3input1 = 3RC1L4X3	X3input2 = 3RC1L4X4
X4input1 = 4RC1L4X3	X4input2 = 4RC1L4X4
Y1input1 = NONE	Y1input2 = NONE
Y2input1 = NONE	Y2input2 = NONE
Y3input1 = NONE	Y3input2 = NONE
Y4input1 = NONE	Y4input2 = NONE

transv. conn. : F
 Switch(RC1L4B2) = 000-00-0-0-000

Board 8 Board num RC1L4B3 CRATE 1 R Slot = 8

X1input1 = 1RC1L4X5	X1input2 = 1RC1L4X6
X2input1 = 2RC1L4X5	X2input2 = 2RC1L4X6
X3input1 = 3RC1L4X5	X3input2 = 3RC1L4X6
X4input1 = 4RC1L4X5	X4input2 = 4RC1L4X6
Y1input1 = NONE	Y1input2 = NONE
Y2input1 = NONE	Y2input2 = NONE
Y3input1 = NONE	Y3input2 = NONE
Y4input1 = NONE	Y4input2 = NONE

transv. conn. : F
 Switch(RC1L4B3) = 000-00-0-0-001

Board 9 Board num RC1L6B1 CRATE 1 R Slot = 9

X1input1 = 1RC1L6X1 X1input2 = 1RC1L6X2
X2input1 = 2RC1L6X1 X2input2 = 2RC1L6X2
X3input1 = 3RC1L6X1 X3input2 = 3RC1L6X2
X4input1 = 4RC1L6X1 X4input2 = 4RC1L6X2

Y1input1 = 1RC1L6Y1 Y1input2 = 1RC1L6Y2
Y2input1 = 2RC1L6Y1 Y2input2 = 2RC1L6Y2
Y3input1 = 3RC1L6Y1 Y3input2 = 3RC1L6Y2
Y4input1 = 4RC1L6Y1 Y4input2 = 4RC1L6Y2

transv. conn. : M
Switch(RC1L6B1) = 000-00-1-0-100

Board 10 Board num RC1L6B2 CRATE 1 R Slot = 10

X1input1 = 1RC1L6X3 X1input2 = 1RC1L6X4
X2input1 = 2RC1L6X3 X2input2 = 2RC1L6X4
X3input1 = 3RC1L6X3 X3input2 = 3RC1L6X4
X4input1 = 4RC1L6X3 X4input2 = 4RC1L6X4

Y1input1 = NONE Y1input2 = NONE
Y2input1 = NONE Y2input2 = NONE
Y3input1 = NONE Y3input2 = NONE
Y4input1 = NONE Y4input2 = NONE

transv. conn. : FM
Switch(RC1L6B2) = 000-00-0-0-000

Board 11 Board num RC1L6B3 CRATE 1 R Slot = 11

X1input1 = 1RC1L6X5 X1input2 = 1RC1L6X6
X2input1 = 2RC1L6X5 X2input2 = 2RC1L6X6
X3input1 = 3RC1L6X5 X3input2 = 3RC1L6X6
X4input1 = 4RC1L6X5 X4input2 = 4RC1L6X6

Y1input1 = NONE Y1input2 = NONE
Y2input1 = NONE Y2input2 = NONE
Y3input1 = NONE Y3input2 = NONE
Y4input1 = NONE Y4input2 = NONE

transv. conn. : F
Switch(RC1L6B3) = 000-10-0-0-000

Board 12 Board num RC1L7B1 CRATE 1 R Slot = 12

X1input1 = 1RC1L7X1 X1input2 = 1RC1L7X2
X2input1 = 2RC1L7X1 X2input2 = 2RC1L7X2
X3input1 = 3RC1L7X1 X3input2 = 3RC1L7X2
X4input1 = 4RC1L7X1 X4input2 = 4RC1L7X2

Y1input1 = 1RC1L7Y1 Y1input2 = 1RC1L7Y2
Y2input1 = 2RC1L7Y1 Y2input2 = 2RC1L7Y2
Y3input1 = 3RC1L7Y1 Y3input2 = 3RC1L7Y2
Y4input1 = 4RC1L7Y1 Y4input2 = 4RC1L7Y2

transv. conn. : M
Switch(RC1L7B1) = 000-01-1-0-000

Board 13 Board num RC1L7B2 CRATE 1 R Slot = 13

X1input1 = 1RC1L7X3 X1input2 = 1RC1L7X4
X2input1 = 2RC1L7X3 X2input2 = 2RC1L7X4
X3input1 = 3RC1L7X3 X3input2 = 3RC1L7X4
X4input1 = 4RC1L7X3 X4input2 = 4RC1L7X4

Y1input1 = NONE Y1input2 = NONE
Y2input1 = NONE Y2input2 = NONE
Y3input1 = NONE Y3input2 = NONE
Y4input1 = NONE Y4input2 = NONE

transv. conn. : F
Switch(RC1L7B2) = 001-10-0-0-000

Board 14 Board num RC1L8B1 CRATE 1 R Slot = 14

X1input1 = 1RC1L8X1 X1input2 = 1RC1L8X2
X2input1 = 2RC1L8X1 X2input2 = 2RC1L8X2
X3input1 = 3RC1L8X1 X3input2 = 3RC1L8X2
X4input1 = 4RC1L8X1 X4input2 = 4RC1L8X2

Y1input1 = 1RC1L8Y1 Y1input2 = NONE
Y2input1 = 2RC1L8Y1 Y2input2 = NONE
Y3input1 = 3RC1L8Y1 Y3input2 = NONE
Y4input1 = 4RC1L8Y1 Y4input2 = NONE

transv. conn. : M
Switch(RC1L8B1) = 011-01-1-0-000

Board 15 Board num RC1L8B2 CRATE 1 R Slot = 15

X1input1 = 1RC1L8X3 X1input2 = 1RC1L8X4
X2input1 = 2RC1L8X3 X2input2 = 2RC1L8X4
X3input1 = 3RC1L8X3 X3input2 = 3RC1L8X4
X4input1 = 4RC1L8X3 X4input2 = 4RC1L8X4

Y1input1 = NONE Y1input2 = NONE
Y2input1 = NONE Y2input2 = NONE
Y3input1 = NONE Y3input2 = NONE
Y4input1 = NONE Y4input2 = NONE

transv. conn. : F
Switch(RC1L8B2) = 111-10-0-0-000

Board 16 Board num RC1L9B1 CRATE 1 R Slot = 16

X1input1 = 1RC1L9X1 X1input2 = 1RC1L9X2
X2input1 = 2RC1L9X1 X2input2 = 2RC1L9X2
X3input1 = 3RC1L9X1 X3input2 = 3RC1L9X2
X4input1 = 4RC1L9X1 X4input2 = 4RC1L9X2

Y1input1 = 1RC1L9Y1 Y1input2 = NONE
Y2input1 = 2RC1L9Y1 Y2input2 = NONE
Y3input1 = 3RC1L9Y1 Y3input2 = NONE
Y4input1 = 4RC1L9Y1 Y4input2 = NONE

transv. conn. NONE
Switch(RC1L9B1) = 110-01-1-0-001

Board 17 Board num RC2L1B1 CRATE 2 R Slot = 1

X1input1 = 1RC2L1X1 X1input2 = 1RC2L1X2
X2input1 = 2RC2L1X1 X2input2 = 2RC2L1X2
X3input1 = 3RC2L1X1 X3input2 = 3RC2L1X2
X4input1 = 4RC2L1X1 X4input2 = 4RC2L1X2

Y1input1 = 1RC2L1Y1 Y1input2 = NONE
Y2input1 = 2RC2L1Y1 Y2input2 = NONE
Y3input1 = 3RC2L1Y1 Y3input2 = NONE
Y4input1 = 4RC2L1Y1 Y4input2 = NONE

transv. conn. NONE
Switch(RC2L1B1) = 011-10-1-0-100

Board 18 Board num RC2L2B1 CRATE 2 R Slot = 2

X1input1 = 1RC2L2X1 X1input2 = 1RC2L2X2
X2input1 = 2RC2L2X1 X2input2 = 2RC2L2X2
X3input1 = 3RC2L2X1 X3input2 = 3RC2L2X2
X4input1 = 4RC2L2X1 X4input2 = 4RC2L2X2

Y1input1 = 1RC2L2Y1 Y1input2 = NONE
Y2input1 = 2RC2L2Y1 Y2input2 = NONE
Y3input1 = 3RC2L2Y1 Y3input2 = NONE
Y4input1 = 4RC2L2Y1 Y4input2 = NONE

transv. conn. : M
Switch(RC2L2B1) = 111-01-1-0-000

Board 19 Board num RC2L2B2 CRATE 2 R Slot = 3

X1input1 = 1RC2L2X3 X1input2 = 1RC2L2X4
X2input1 = 2RC2L2X3 X2input2 = 2RC2L2X4
X3input1 = 3RC2L2X3 X3input2 = 3RC2L2X4
X4input1 = 4RC2L2X3 X4input2 = 4RC2L2X4

Y1input1 = NONE Y1input2 = NONE
Y2input1 = NONE Y2input2 = NONE
Y3input1 = NONE Y3input2 = NONE
Y4input1 = NONE Y4input2 = NONE

transv. conn. : F
Switch(RC2L2B2) = 110-10-0-0-000

Board 20 Board num RC2L3B1 CRATE 2 R Slot = 4

X1input1 = 1RC2L3X1 X1input2 = 1RC2L3X2
X2input1 = 2RC2L3X1 X2input2 = 2RC2L3X2
X3input1 = 3RC2L3X1 X3input2 = 3RC2L3X2
X4input1 = 4RC2L3X1 X4input2 = 4RC2L3X2

Y1input1 = 1RC2L3Y1 Y1input2 = 1RC2L3Y2
Y2input1 = 2RC2L3Y1 Y2input2 = 2RC2L3Y2
Y3input1 = 3RC2L3Y1 Y3input2 = 3RC2L3Y2
Y4input1 = 4RC2L3Y1 Y4input2 = 4RC2L3Y2

transv. conn. : M
Switch(RC2L3B1) = 100-01-1-0-000

Board 21 Board num RC2L3B2 CRATE 2 R Slot = 5

X1input1 = 1RC2L3X3 X1input2 = 1RC2L3X4
X2input1 = 2RC2L3X3 X2input2 = 2RC2L3X4
X3input1 = 3RC2L3X3 X3input2 = 3RC2L3X4
X4input1 = 4RC2L3X3 X4input2 = 4RC2L3X4

Y1input1 = NONE Y1input2 = NONE
Y2input1 = NONE Y2input2 = NONE
Y3input1 = NONE Y3input2 = NONE
Y4input1 = NONE Y4input2 = NONE

transv. conn. : F
Switch(RC2L3B2) = 000-10-0-0-000

Board 22 Board num RC2L4B1 CRATE 2 R Slot = 6

X1input1 = 1RC2L4X1 X1input2 = 1RC2L4X2
X2input1 = 2RC2L4X1 X2input2 = 2RC2L4X2
X3input1 = 3RC2L4X1 X3input2 = 3RC2L4X2
X4input1 = 4RC2L4X1 X4input2 = 4RC2L4X2

Y1input1 = 1RC2L4Y1 Y1input2 = 1RC2L4Y2
Y2input1 = 2RC2L4Y1 Y2input2 = 2RC2L4Y2
Y3input1 = 3RC2L4Y1 Y3input2 = 3RC2L4Y2
Y4input1 = 4RC2L4Y1 Y4input2 = 4RC2L4Y2

transv. conn. : M
Switch(RC2L4B1) = 000-01-1-0-000

Board 23 Board num RC2L4B2 CRATE 2 R Slot = 7

X1input1 = 1RC2L4X3 X1input2 = 1RC2L4X4
X2input1 = 2RC2L4X3 X2input2 = 2RC2L4X4
X3input1 = 3RC2L4X3 X3input2 = 3RC2L4X4
X4input1 = 4RC2L4X3 X4input2 = 4RC2L4X4

Y1input1 = NONE Y1input2 = NONE
Y2input1 = NONE Y2input2 = NONE
Y3input1 = NONE Y3input2 = NONE
Y4input1 = NONE Y4input2 = NONE

transv. conn. : FM
Switch(RC2L4B2) = 000-00-0-0-000

Board 24 Board num RC2L4B3 CRATE 2 R Slot = 8

X1input1 = 1RC2L4X5 X1input2 = 1RC2L4X6
X2input1 = 2RC2L4X5 X2input2 = 2RC2L4X6
X3input1 = 3RC2L4X5 X3input2 = 3RC2L4X6
X4input1 = 4RC2L4X5 X4input2 = 4RC2L4X6

Y1input1 = NONE Y1input2 = NONE
Y2input1 = NONE Y2input2 = NONE
Y3input1 = NONE Y3input2 = NONE
Y4input1 = NONE Y4input2 = NONE

transv. conn. : FM
Switch(RC2L4B3) = 000-00-0-0-000

Board 25 Board num RC2L4B4 CRATE 2 R Slot = 9

X1input1 = 1RC2L4X7 X1input2 = 1RC2L4X8
X2input1 = 2RC2L4X7 X2input2 = 2RC2L4X8
X3input1 = 3RC2L4X7 X3input2 = 3RC2L4X8
X4input1 = 4RC2L4X7 X4input2 = 4RC2L4X8

Y1input1 = NONE Y1input2 = NONE
Y2input1 = NONE Y2input2 = NONE
Y3input1 = NONE Y3input2 = NONE
Y4input1 = NONE Y4input2 = NONE

transv. conn. : F
Switch(RC2L4B4) = 000-10-0-0-000

Board 26 Board num RC2L5B1 CRATE 2 R Slot = 10

X1input1 = 1RC2L5X1 X1input2 = 1RC2L5X2
X2input1 = 2RC2L5X1 X2input2 = 2RC2L5X2
X3input1 = 3RC2L5X1 X3input2 = 3RC2L5X2
X4input1 = 4RC2L5X1 X4input2 = 4RC2L5X2

Y1input1 = NONE Y1input2 = 1RC2L5Y2
Y2input1 = NONE Y2input2 = 2RC2L5Y2
Y3input1 = NONE Y3input2 = 3RC2L5Y2
Y4input1 = NONE Y4input2 = 4RC2L5Y2

transv. conn. : M
Switch(RC2L5B1) = 000-01-1-1-000

Board 27 Board num RC2L5B2 CRATE 2 R Slot = 11

X1input1 = 1RC2L5X3 X1input2 = 1RC2L5X4
X2input1 = 2RC2L5X3 X2input2 = 2RC2L5X4
X3input1 = 3RC2L5X3 X3input2 = 3RC2L5X4
X4input1 = 4RC2L5X3 X4input2 = 4RC2L5X4

Y1input1 = NONE Y1input2 = NONE
Y2input1 = NONE Y2input2 = NONE
Y3input1 = NONE Y3input2 = NONE
Y4input1 = NONE Y4input2 = NONE

transv. conn. : FM
Switch(RC2L5B2) = 000-00-0-1-000

Board 28 Board num RC2L5B3 CRATE 2 R Slot = 12

X1input1 = 1RC2L5X5 X1input2 = 1RC2L5X6
X2input1 = 2RC2L5X5 X2input2 = 2RC2L5X6
X3input1 = 3RC2L5X5 X3input2 = 3RC2L5X6
X4input1 = 4RC2L5X5 X4input2 = 4RC2L5X6

Y1input1 = NONE Y1input2 = NONE
Y2input1 = NONE Y2input2 = NONE
Y3input1 = NONE Y3input2 = NONE
Y4input1 = NONE Y4input2 = NONE

transv. conn. : FM
Switch(RC2L5B3) = 000-00-0-1-000

Board 29 Board num RC2L5B4 CRATE 2 R Slot = 13

X1input1 = 1RC2L5X7 X1input2 = 1RC2L5X8
X2input1 = 2RC2L5X7 X2input2 = 2RC2L5X8
X3input1 = 3RC2L5X7 X3input2 = 3RC2L5X8
X4input1 = 4RC2L5X7 X4input2 = 4RC2L5X8

Y1input1 = NONE Y1input2 = NONE
Y2input1 = NONE Y2input2 = NONE
Y3input1 = NONE Y3input2 = NONE
Y4input1 = NONE Y4input2 = NONE

transv. conn. : F
Switch(RC2L5B4) = 000-10-0-1-000

Board 30 Board num RC2L6B1 CRATE 2 R Slot = 14

X1input1 = 1RC2L6X1 X1input2 = 1RC2L6X2
X2input1 = 2RC2L6X1 X2input2 = 2RC2L6X2
X3input1 = 3RC2L6X1 X3input2 = 3RC2L6X2
X4input1 = 4RC2L6X1 X4input2 = 4RC2L6X2

Y1input1 = 1RC2L6Y1 (1) Y1input2 = 1RC2L6Y2 (1)
Y2input1 = 2RC2L6Y1 (1) Y2input2 = 2RC2L6Y2 (1)
Y3input1 = 3RC2L6Y1 (1) Y3input2 = 3RC2L6Y2 (1)
Y4input1 = 4RC2L6Y1 (1) Y4input2 = 4RC2L6Y2 (1)

transv. conn. : M
Switch(RC2L6B1) = 000-01-1-0-000

Board 31 Board num RC2L6B2 CRATE 2 R Slot = 15

X1input1 = 1RC2L6X3 X1input2 = 1RC2L6X4
X2input1 = 2RC2L6X3 X2input2 = 2RC2L6X4
X3input1 = 3RC2L6X3 X3input2 = 3RC2L6X4 (1)
X4input1 = 4RC2L6X3 X4input2 = 4RC2L6X4 (1)

Y1input1 = NONE Y1input2 = NONE
Y2input1 = NONE Y2input2 = NONE
Y3input1 = NONE Y3input2 = NONE
Y4input1 = NONE Y4input2 = NONE

transv. conn. : F
Switch(RC2L6B2) = 000-00-0-0-000

Board nn Board num RIntC2-Up CRATE 2 R Slot = 16

X1input1 = NONE X1input2 = NONE
X2input1 = NONE X2input2 = NONE
X3input1 = 3RC2L6X5 (2) X3input2 = NONE
X4input1 = 4RC2L6X5 (2) X4input2 = NONE

Y1input1 = NONE Y1input2 = NONE
Y2input1 = NONE Y2input2 = NONE
Y3input1 = NONE Y3input2 = NONE
Y4input1 = NONE Y4input2 = NONE

transv. conn. NONE
Switch(RIntC2-Up) = NONE

Board nn Board num RIntC2-Dw CRATE 2-3 R Slot = 1

X1input1 = NONE X1input2 = NONE
X2input1 = NONE X2input2 = NONE
X3input1 = NONE X3input2 = 3RC2L6X4 (2)
X4input1 = NONE X4input2 = 4RC2L6X4 (2)

Y1input1 = NONE Y1input2 = NONE
Y2input1 = NONE Y2input2 = NONE
Y3input1 = NONE Y3input2 = NONE
Y4input1 = NONE Y4input2 = NONE

transv. conn. NONE
Switch(RIntC2-Dw) = NONE

Board 32 Board num RC2L6B3 CRATE 2-3 R Slot = 2

X1input1 = 1RC2L6X5 X1input2 = 1RC2L6X6
X2input1 = 2RC2L6X5 X2input2 = 2RC2L6X6
X3input1 = 3RC2L6X5 (1) X3input2 = 3RC2L6X6
X4input1 = 4RC2L6X5 (1) X4input2 = 4RC2L6X6

Y1input1 = 1RC2L6Y1 (2) Y1input2 = 1RC2L6Y2 (2)
Y2input1 = 2RC2L6Y1 (2) Y2input2 = 2RC2L6Y2 (2)
Y3input1 = 3RC2L6Y1 (2) Y3input2 = 3RC2L6Y2 (2)
Y4input1 = 4RC2L6Y1 (2) Y4input2 = 4RC2L6Y2 (2)

transv. conn. : M
Switch(RC2L6B3) = 000-00-1-0-000

Board 33 Board num RC2L6B4 CRATE 2-3 R Slot = 3

X1input1 = 1RC2L6X7 X1input2 = 1RC2L6X8
X2input1 = 2RC2L6X7 X2input2 = 2RC2L6X8
X3input1 = 3RC2L6X7 X3input2 = 3RC2L6X8
X4input1 = 4RC2L6X7 X4input2 = 4RC2L6X8

Y1input1 = NONE Y1input2 = NONE
Y2input1 = NONE Y2input2 = NONE
Y3input1 = NONE Y3input2 = NONE
Y4input1 = NONE Y4input2 = NONE

transv. conn. : F
Switch(RC2L6B4) = 000-10-0-0-000

Board 34 Board num RC2L7B1 CRATE 2-3 R Slot = 4

X1input1 = 1RC2L7X1 X1input2 = 1RC2L7X2
X2input1 = 2RC2L7X1 X2input2 = 2RC2L7X2
X3input1 = 3RC2L7X1 X3input2 = 3RC2L7X2
X4input1 = 4RC2L7X1 X4input2 = 4RC2L7X2

Y1input1 = 1RC2L7Y1 Y1input2 = 1RC2L7Y2
Y2input1 = 2RC2L7Y1 Y2input2 = 2RC2L7Y2
Y3input1 = 3RC2L7Y1 Y3input2 = 3RC2L7Y2
Y4input1 = 4RC2L7Y1 Y4input2 = 4RC2L7Y2

transv. conn. : M
Switch(RC2L7B1) = 000-01-1-0-000

Board 35 Board num RC2L7B2 CRATE 2-3 R Slot = 5

X1input1 = 1RC2L7X3 X1input2 = 1RC2L7X4
X2input1 = 2RC2L7X3 X2input2 = 2RC2L7X4
X3input1 = 3RC2L7X3 X3input2 = 3RC2L7X4
X4input1 = 4RC2L7X3 X4input2 = 4RC2L7X4

Y1input1 = NONE Y1input2 = NONE
Y2input1 = NONE Y2input2 = NONE
Y3input1 = NONE Y3input2 = NONE
Y4input1 = NONE Y4input2 = NONE

transv. conn. : F
Switch(RC2L7B2) = 001-10-0-0-000

Board 36 Board num RC2L8B1 CRATE 2-3 R Slot = 6

X1input1 = 1RC2L8X1 X1input2 = 1RC2L8X2
X2input1 = 2RC2L8X1 X2input2 = 2RC2L8X2
X3input1 = 3RC2L8X1 X3input2 = 3RC2L8X2
X4input1 = 4RC2L8X1 X4input2 = 4RC2L8X2

Y1input1 = 1RC2L8Y1 Y1input2 = NONE
Y2input1 = 2RC2L8Y1 Y2input2 = NONE
Y3input1 = 3RC2L8Y1 Y3input2 = NONE
Y4input1 = 4RC2L8Y1 Y4input2 = NONE

transv. conn. : M
Switch(RC2L8B1) = 011-01-1-0-000

Board 37 Board num RC2L8B2 CRATE 2-3 R Slot = 7

X1input1 = 1RC2L8X3 X1input2 = 1RC2L8X4
X2input1 = 2RC2L8X3 X2input2 = 2RC2L8X4
X3input1 = 3RC2L8X3 X3input2 = 3RC2L8X4
X4input1 = 4RC2L8X3 X4input2 = 4RC2L8X4

Y1input1 = NONE Y1input2 = NONE
Y2input1 = NONE Y2input2 = NONE
Y3input1 = NONE Y3input2 = NONE
Y4input1 = NONE Y4input2 = NONE

transv. conn. : F
Switch(RC2L8B2) = 111-10-0-0-000

Board 38 Board num RC2L9B1 CRATE 2-3 R Slot = 8

X1input1 = 1RC2L9X1 X1input2 = 1RC2L9X2
X2input1 = 2RC2L9X1 X2input2 = 2RC2L9X2
X3input1 = 3RC2L9X1 X3input2 = 3RC2L9X2
X4input1 = 4RC2L9X1 X4input2 = 4RC2L9X2

Y1input1 = 1RC2L9Y1 Y1input2 = NONE
Y2input1 = 2RC2L9Y1 Y2input2 = NONE
Y3input1 = 3RC2L9Y1 Y3input2 = NONE
Y4input1 = 4RC2L9Y1 Y4input2 = NONE

transv. conn. NONE
Switch(RC2L9B1) = 110-01-1-0-001

Board 39 Board num RC3L1B1 CRATE 3 R Slot = 1

X1input1 = 1RC3L1X1 X1input2 = 1RC3L1X2
X2input1 = 2RC3L1X1 X2input2 = 2RC3L1X2
X3input1 = 3RC3L1X1 X3input2 = 3RC3L1X2
X4input1 = 4RC3L1X1 X4input2 = 4RC3L1X2

Y1input1 = 1RC3L1Y1 Y1input2 = NONE
Y2input1 = 2RC3L1Y1 Y2input2 = NONE
Y3input1 = 3RC3L1Y1 Y3input2 = NONE
Y4input1 = 4RC3L1Y1 Y4input2 = NONE

transv. conn. NONE
Switch(RC3L1B1) = 011-10-1-0-100

Board 40 Board num RC3L2B1 CRATE 3 R Slot = 2

X1input1 = 1RC3L2X1 X1input2 = 1RC3L2X2
X2input1 = 2RC3L2X1 X2input2 = 2RC3L2X2
X3input1 = 3RC3L2X1 X3input2 = 3RC3L2X2
X4input1 = 4RC3L2X1 X4input2 = 4RC3L2X2

Y1input1 = 1RC3L2Y1 Y1input2 = NONE
Y2input1 = 2RC3L2Y1 Y2input2 = NONE
Y3input1 = 3RC3L2Y1 Y3input2 = NONE
Y4input1 = 4RC3L2Y1 Y4input2 = NONE

transv. conn. : M
Switch(RC3L2B1) = 111-01-1-0-000

Board 41 Board num RC3L2B2 CRATE 3 R Slot = 3

X1input1 = 1RC3L2X3 X1input2 = 1RC3L2X4
X2input1 = 2RC3L2X3 X2input2 = 2RC3L2X4
X3input1 = 3RC3L2X3 X3input2 = 3RC3L2X4
X4input1 = 4RC3L2X3 X4input2 = 4RC3L2X4

Y1input1 = NONE Y1input2 = NONE
Y2input1 = NONE Y2input2 = NONE
Y3input1 = NONE Y3input2 = NONE
Y4input1 = NONE Y4input2 = NONE

transv. conn. : F
Switch(RC3L2B2) = 110-10-0-0-000

Board 42 Board num RC3L3B1 CRATE 3 R Slot = 4

X1input1 = 1RC3L3X1 X1input2 = 1RC3L3X2
X2input1 = 2RC3L3X1 X2input2 = 2RC3L3X2
X3input1 = 3RC3L3X1 X3input2 = 3RC3L3X2
X4input1 = 4RC3L3X1 X4input2 = 4RC3L3X2

Y1input1 = 1RC3L3Y1 Y1input2 = 1RC3L3Y2
Y2input1 = 2RC3L3Y1 Y2input2 = 2RC3L3Y2
Y3input1 = 3RC3L3Y1 Y3input2 = 3RC3L3Y2
Y4input1 = 4RC3L3Y1 Y4input2 = 4RC3L3Y2

transv. conn. : M
Switch(RC3L3B1) = 100-01-1-0-000

Board 43 Board num RC3L3B2 CRATE 3 R Slot = 5

X1input1 = 1RC3L3X3 X1input2 = 1RC3L3X4
X2input1 = 2RC3L3X3 X2input2 = 2RC3L3X4
X3input1 = 3RC3L3X3 X3input2 = 3RC3L3X4
X4input1 = 4RC3L3X3 X4input2 = 4RC3L3X4

Y1input1 = NONE Y1input2 = NONE
Y2input1 = NONE Y2input2 = NONE
Y3input1 = NONE Y3input2 = NONE
Y4input1 = NONE Y4input2 = NONE

transv. conn. : F
Switch(RC3L3B2) = 000-10-0-0-000

Board 44 Board num RC3L4B1 CRATE 3 R Slot = 6

X1input1 = 1RC3L4X1 X1input2 = 1RC3L4X2
X2input1 = 2RC3L4X1 X2input2 = 2RC3L4X2
X3input1 = 3RC3L4X1 X3input2 = 3RC3L4X2
X4input1 = 4RC3L4X1 X4input2 = 4RC3L4X2

Y1input1 = 1RC3L4Y1 Y1input2 = 1RC3L4Y2
Y2input1 = 2RC3L4Y1 Y2input2 = 2RC3L4Y2
Y3input1 = 3RC3L4Y1 Y3input2 = 3RC3L4Y2
Y4input1 = 4RC3L4Y1 Y4input2 = 4RC3L4Y2

transv. conn. : M
Switch(RC3L4B1) = 000-01-1-0-000

Board 45 Board num RC3L4B2 CRATE 3 R Slot = 7

X1input1 = 1RC3L4X3 X1input2 = 1RC3L4X4
X2input1 = 2RC3L4X3 X2input2 = 2RC3L4X4
X3input1 = 3RC3L4X3 X3input2 = 3RC3L4X4
X4input1 = 4RC3L4X3 X4input2 = 4RC3L4X4

Y1input1 = NONE Y1input2 = NONE
Y2input1 = NONE Y2input2 = NONE
Y3input1 = NONE Y3input2 = NONE
Y4input1 = NONE Y4input2 = NONE

transv. conn. : FM
Switch(RC3L4B2) = 000-00-0-0-000

Board 46 Board num RC3L4B3 CRATE 3 R Slot = 8

X1input1 = 1RC3L4X5 X1input2 = 1RC3L4X6
X2input1 = 2RC3L4X5 X2input2 = 2RC3L4X6
X3input1 = 3RC3L4X5 X3input2 = 3RC3L4X6
X4input1 = 4RC3L4X5 X4input2 = 4RC3L4X6

Y1input1 = NONE Y1input2 = NONE
Y2input1 = NONE Y2input2 = NONE
Y3input1 = NONE Y3input2 = NONE
Y4input1 = NONE Y4input2 = NONE

transv. conn. : FM
Switch(RC3L4B3) = 000-00-0-0-000

Board 47 Board num RC3L4B4 CRATE 3 R Slot = 9

X1input1 = 1RC3L4X7 X1input2 = 1RC3L4X8
X2input1 = 2RC3L4X7 X2input2 = 2RC3L4X8
X3input1 = 3RC3L4X7 X3input2 = 3RC3L4X8
X4input1 = 4RC3L4X7 X4input2 = 4RC3L4X8

Y1input1 = NONE Y1input2 = NONE
Y2input1 = NONE Y2input2 = NONE
Y3input1 = NONE Y3input2 = NONE
Y4input1 = NONE Y4input2 = NONE

transv. conn. : F
Switch(RC3L4B4) = 000-10-0-0-000

Board 48 Board num RC3L5B1 CRATE 3 R Slot = 10

X1input1 = 1RC3L5X1 X1input2 = 1RC3L5X2
X2input1 = 2RC3L5X1 X2input2 = 2RC3L5X2
X3input1 = 3RC3L5X1 X3input2 = 3RC3L5X2
X4input1 = 4RC3L5X1 X4input2 = 4RC3L5X2

Y1input1 = 1RC3L5Y1 Y1input2 = 1RC3L5Y2
Y2input1 = 2RC3L5Y1 Y2input2 = 2RC3L5Y2
Y3input1 = 3RC3L5Y1 Y3input2 = 3RC3L5Y2
Y4input1 = 4RC3L5Y1 Y4input2 = 4RC3L5Y2

transv. conn. : M
Switch(RC3L5B1) = 000-01-1-0-000

Board 49 Board num RC3L5B2 CRATE 3 R Slot = 11

X1input1 = 1RC3L5X3 X1input2 = 1RC3L5X4
X2input1 = 2RC3L5X3 X2input2 = 2RC3L5X4
X3input1 = 3RC3L5X3 X3input2 = 3RC3L5X4
X4input1 = 4RC3L5X3 X4input2 = 4RC3L5X4

Y1input1 = NONE Y1input2 = NONE
Y2input1 = NONE Y2input2 = NONE
Y3input1 = NONE Y3input2 = NONE
Y4input1 = NONE Y4input2 = NONE

transv. conn. : FM
Switch(RC3L5B2) = 000-00-0-0-000

Board 50 Board num RC3L5B3 CRATE 3 R Slot = 12

X1input1 = 1RC3L5X5 X1input2 = 1RC3L5X6
X2input1 = 2RC3L5X5 X2input2 = 2RC3L5X6
X3input1 = 3RC3L5X5 X3input2 = 3RC3L5X6
X4input1 = 4RC3L5X5 X4input2 = 4RC3L5X6

Y1input1 = NONE Y1input2 = NONE
Y2input1 = NONE Y2input2 = NONE
Y3input1 = NONE Y3input2 = NONE
Y4input1 = NONE Y4input2 = NONE

transv. conn. : FM
Switch(RC3L5B3) = 000-00-0-0-000

Board 51 Board num RC3L5B4 CRATE 3 R Slot = 13

X1input1 = 1RC3L5X7 X1input2 = 1RC3L5X8
X2input1 = 2RC3L5X7 X2input2 = 2RC3L5X8
X3input1 = 3RC3L5X7 X3input2 = 3RC3L5X8
X4input1 = 4RC3L5X7 X4input2 = 4RC3L5X8

Y1input1 = NONE Y1input2 = NONE
Y2input1 = NONE Y2input2 = NONE
Y3input1 = NONE Y3input2 = NONE
Y4input1 = NONE Y4input2 = NONE

transv. conn. : F
Switch(RC3L5B4) = 000-10-0-0-000

Board 52 Board num RC3L6B1 CRATE 3 R Slot = 14

X1input1 = 1RC3L6X1 X1input2 = 1RC3L6X2
X2input1 = 2RC3L6X1 X2input2 = 2RC3L6X2
X3input1 = 3RC3L6X1 X3input2 = 3RC3L6X2
X4input1 = 4RC3L6X1 X4input2 = 4RC3L6X2

Y1input1 = 1RC3L6Y1 (1) Y1input2 = 1RC3L6Y2 (1)
Y2input1 = 2RC3L6Y1 (1) Y2input2 = 2RC3L6Y2 (1)
Y3input1 = 3RC3L6Y1 (1) Y3input2 = 3RC3L6Y2 (1)
Y4input1 = 4RC3L6Y1 (1) Y4input2 = 4RC3L6Y2 (1)

transv. conn. : M
Switch(RC3L6B1) = 000-01-1-0-000

Board 53 Board num RC3L6B2 CRATE 3 R Slot = 15

X1input1 = 1RC3L6X3 X1input2 = 1RC3L6X4
X2input1 = 2RC3L6X3 X2input2 = 2RC3L6X4
X3input1 = 3RC3L6X3 X3input2 = 3RC3L6X4
X4input1 = 4RC3L6X3 X4input2 = 4RC3L6X4

Y1input1 = NONE Y1input2 = NONE
Y2input1 = NONE Y2input2 = NONE
Y3input1 = NONE Y3input2 = NONE
Y4input1 = NONE Y4input2 = NONE

transv. conn. : F
Switch(RC3L6B2) = 000-00-0-0-000

Board nn Board num RIntC3-Up CRATE 3 R Slot = 16

X1input1 = NONE X1input2 = NONE
X2input1 = NONE X2input2 = NONE
X3input1 = 3RC3L6X5 (2) X3input2 = NONE
X4input1 = 4RC3L6X5 (2) X4input2 = NONE

Y1input1 = NONE Y1input2 = NONE
Y2input1 = NONE Y2input2 = NONE
Y3input1 = NONE Y3input2 = NONE
Y4input1 = NONE Y4input2 = NONE

transv. conn. NONE
Switch(RIntC3-Up) = NONE

Board nn Board num RIntC3-Dw CRATE 2-3 R Slot = 9

X1input1 = NONE X1input2 = NONE
X2input1 = NONE X2input2 = NONE
X3input1 = NONE X3input2 = 3RC3L6X4 (2)
X4input1 = NONE X4input2 = 4RC3L6X4 (2)

Y1input1 = NONE Y1input2 = NONE
Y2input1 = NONE Y2input2 = NONE
Y3input1 = NONE Y3input2 = NONE
Y4input1 = NONE Y4input2 = NONE

transv. conn. NONE
Switch(RIntC3-Dw) = NONE

Board 54 Board num RC3L6B3 CRATE 2-3 R Slot = 10

X1input1 = 1RC3L6X5 X1input2 = 1RC3L6X6
X2input1 = 2RC3L6X5 X2input2 = 2RC3L6X6
X3input1 = 3RC3L6X5 (1) X3input2 = 3RC3L6X6
X4input1 = 4RC3L6X5 (1) X4input2 = 4RC3L6X6

Y1input1 = 1RC3L6Y1 (2) Y1input2 = 1RC3L6Y2 (2)
Y2input1 = 2RC3L6Y1 (2) Y2input2 = 2RC3L6Y2 (2)
Y3input1 = 3RC3L6Y1 (2) Y3input2 = 3RC3L6Y2 (2)
Y4input1 = 4RC3L6Y1 (2) Y4input2 = 4RC3L6Y2 (2)

transv. conn. : M
Switch(RC3L6B3) = 000-00-1-0-000

Board 55 Board num RC3L6B4 CRATE 2-3 R Slot = 11

X1input1 = 1RC3L6X7 X1input2 = 1RC3L6X8
X2input1 = 2RC3L6X7 X2input2 = 2RC3L6X8
X3input1 = 3RC3L6X7 X3input2 = 3RC3L6X8
X4input1 = 4RC3L6X7 X4input2 = 4RC3L6X8

Y1input1 = NONE Y1input2 = NONE
Y2input1 = NONE Y2input2 = NONE
Y3input1 = NONE Y3input2 = NONE
Y4input1 = NONE Y4input2 = NONE

transv. conn. : F
Switch(RC3L6B4) = 000-10-0-0-000

Board 56 Board num RC3L7B1 CRATE 2-3 R Slot = 12

X1input1 = 1RC3L7X1 X1input2 = 1RC3L7X2
X2input1 = 2RC3L7X1 X2input2 = 2RC3L7X2
X3input1 = 3RC3L7X1 X3input2 = 3RC3L7X2
X4input1 = 4RC3L7X1 X4input2 = 4RC3L7X2

Y1input1 = 1RC3L7Y1 Y1input2 = 1RC3L7Y2
Y2input1 = 2RC3L7Y1 Y2input2 = 2RC3L7Y2
Y3input1 = 3RC3L7Y1 Y3input2 = 3RC3L7Y2
Y4input1 = 4RC3L7Y1 Y4input2 = 4RC3L7Y2

transv. conn. : M
Switch(RC3L7B1) = 000-01-1-0-000

Board 57 Board num RC3L7B2 CRATE 2-3 R Slot = 13

X1input1 = 1RC3L7X3 X1input2 = 1RC3L7X4
X2input1 = 2RC3L7X3 X2input2 = 2RC3L7X4
X3input1 = 3RC3L7X3 X3input2 = 3RC3L7X4
X4input1 = 4RC3L7X3 X4input2 = 4RC3L7X4

Y1input1 = NONE Y1input2 = NONE
Y2input1 = NONE Y2input2 = NONE
Y3input1 = NONE Y3input2 = NONE
Y4input1 = NONE Y4input2 = NONE

transv. conn. : F
Switch(RC3L7B2) = 001-10-0-0-000

Board 58 Board num RC3L8B1 CRATE 2-3 R Slot = 14

X1input1 = 1RC3L8X1 X1input2 = 1RC3L8X2
X2input1 = 2RC3L8X1 X2input2 = 2RC3L8X2
X3input1 = 3RC3L8X1 X3input2 = 3RC3L8X2
X4input1 = 4RC3L8X1 X4input2 = 4RC3L8X2

Y1input1 = 1RC3L8Y1 Y1input2 = NONE
Y2input1 = 2RC3L8Y1 Y2input2 = NONE
Y3input1 = 3RC3L8Y1 Y3input2 = NONE
Y4input1 = 4RC3L8Y1 Y4input2 = NONE

transv. conn. : M
Switch(RC3L8B1) = 011-01-1-0-000

Board 59 Board num RC3L8B2 CRATE 2-3 R Slot = 15

X1input1 = 1RC3L8X3 X1input2 = 1RC3L8X4
X2input1 = 2RC3L8X3 X2input2 = 2RC3L8X4
X3input1 = 3RC3L8X3 X3input2 = 3RC3L8X4
X4input1 = 4RC3L8X3 X4input2 = 4RC3L8X4

Y1input1 = NONE Y1input2 = NONE
Y2input1 = NONE Y2input2 = NONE
Y3input1 = NONE Y3input2 = NONE
Y4input1 = NONE Y4input2 = NONE

transv. conn. : F
Switch(RC3L8B2) = 111-10-0-0-000

Board 60 Board num RC3L9B1 CRATE 2-3 R Slot = 16

X1input1 = 1RC3L9X1 X1input2 = 1RC3L9X2
X2input1 = 2RC3L9X1 X2input2 = 2RC3L9X2
X3input1 = 3RC3L9X1 X3input2 = 3RC3L9X2
X4input1 = 4RC3L9X1 X4input2 = 4RC3L9X2

Y1input1 = 1RC3L9Y1 Y1input2 = NONE
Y2input1 = 2RC3L9Y1 Y2input2 = NONE
Y3input1 = 3RC3L9Y1 Y3input2 = NONE
Y4input1 = 4RC3L9Y1 Y4input2 = NONE

transv. conn. NONE
Switch(RC3L9B1) = 110-01-1-0-001

Board 61 Board num RC4L1B1 CRATE 4 R Slot = 1

X1input1 = 1RC4L1X1 X1input2 = 1RC4L1X2
X2input1 = 2RC4L1X1 X2input2 = 2RC4L1X2
X3input1 = 3RC4L1X1 X3input2 = 3RC4L1X2
X4input1 = 4RC4L1X1 X4input2 = 4RC4L1X2

Y1input1 = 1RC4L1Y1 Y1input2 = NONE
Y2input1 = 2RC4L1Y1 Y2input2 = NONE
Y3input1 = 3RC4L1Y1 Y3input2 = NONE
Y4input1 = 4RC4L1Y1 Y4input2 = NONE

transv. conn. NONE
Switch(RC4L1B1) = 011-10-1-0-100

Board 62 Board num RC4L2B1 CRATE 4 R Slot = 2

X1input1 = 1RC4L2X1 X1input2 = 1RC4L2X2
X2input1 = 2RC4L2X1 X2input2 = 2RC4L2X2
X3input1 = 3RC4L2X1 X3input2 = 3RC4L2X2
X4input1 = 4RC4L2X1 X4input2 = 4RC4L2X2

Y1input1 = 1RC4L2Y1 Y1input2 = NONE
Y2input1 = 2RC4L2Y1 Y2input2 = NONE
Y3input1 = 3RC4L2Y1 Y3input2 = NONE
Y4input1 = 4RC4L2Y1 Y4input2 = NONE

transv. conn. : M
Switch(RC4L2B1) = 111-01-1-0-000

Board 63 Board num RC4L2B2 CRATE 4 R Slot = 3

X1input1 = 1RC4L2X3 X1input2 = 1RC4L2X4
X2input1 = 2RC4L2X3 X2input2 = 2RC4L2X4
X3input1 = 3RC4L2X3 X3input2 = 3RC4L2X4
X4input1 = 4RC4L2X3 X4input2 = 4RC4L2X4

Y1input1 = NONE Y1input2 = NONE
Y2input1 = NONE Y2input2 = NONE
Y3input1 = NONE Y3input2 = NONE
Y4input1 = NONE Y4input2 = NONE

transv. conn. : F
Switch(RC4L2B2) = 110-10-0-0-000

Board 64 Board num RC4L3B1 CRATE 4 R Slot = 4

X1input1 = 1RC4L3X1 X1input2 = 1RC4L3X2
X2input1 = 2RC4L3X1 X2input2 = 2RC4L3X2
X3input1 = 3RC4L3X1 X3input2 = 3RC4L3X2
X4input1 = 4RC4L3X1 X4input2 = 4RC4L3X2

Y1input1 = 1RC4L3Y1 Y1input2 = 1RC4L3Y2
Y2input1 = 2RC4L3Y1 Y2input2 = 2RC4L3Y2
Y3input1 = 3RC4L3Y1 Y3input2 = 3RC4L3Y2
Y4input1 = 4RC4L3Y1 Y4input2 = 4RC4L3Y2

transv. conn. : M
Switch(RC4L3B1) = 100-01-1-0-000

Board 65 Board num RC4L3B2 CRATE 4 R Slot = 5

X1input1 = 1RC4L3X3 X1input2 = 1RC4L3X4
X2input1 = 2RC4L3X3 X2input2 = 2RC4L3X4
X3input1 = 3RC4L3X3 X3input2 = 3RC4L3X4
X4input1 = 4RC4L3X3 X4input2 = 4RC4L3X4

Y1input1 = NONE Y1input2 = NONE
Y2input1 = NONE Y2input2 = NONE
Y3input1 = NONE Y3input2 = NONE
Y4input1 = NONE Y4input2 = NONE

transv. conn. : F
Switch(RC4L3B2) = 000-10-0-0-000

Board 66 Board num RC4L4B1 CRATE 4 R Slot = 6

X1input1 = 1RC4L4X1 X1input2 = 1RC4L4X2
X2input1 = 2RC4L4X1 X2input2 = 2RC4L4X2
X3input1 = 3RC4L4X1 X3input2 = 3RC4L4X2
X4input1 = 4RC4L4X1 X4input2 = 4RC4L4X2

Y1input1 = 1RC4L4Y1 Y1input2 = 1RC4L4Y2
Y2input1 = 2RC4L4Y1 Y2input2 = 2RC4L4Y2
Y3input1 = 3RC4L4Y1 Y3input2 = 3RC4L4Y2
Y4input1 = 4RC4L4Y1 Y4input2 = 4RC4L4Y2

transv. conn. : M
Switch(RC4L4B1) = 000-01-1-0-000

Board 67 Board num RC4L4B2 CRATE 4 R Slot = 7

X1input1 = 1RC4L4X3 X1input2 = 1RC4L4X4
X2input1 = 2RC4L4X3 X2input2 = 2RC4L4X4
X3input1 = 3RC4L4X3 X3input2 = 3RC4L4X4
X4input1 = 4RC4L4X3 X4input2 = 4RC4L4X4

Y1input1 = NONE Y1input2 = NONE
Y2input1 = NONE Y2input2 = NONE
Y3input1 = NONE Y3input2 = NONE
Y4input1 = NONE Y4input2 = NONE

transv. conn. : F
Switch(RC4L4B2) = 000-10-0-0-000

Board 68 Board num RC4L5B1 CRATE 4 R Slot = 8

X1input1 = 1RC4L5X1 X1input2 = 1RC4L5X2
X2input1 = 2RC4L5X1 X2input2 = 2RC4L5X2
X3input1 = 3RC4L5X1 X3input2 = 3RC4L5X2
X4input1 = 4RC4L5X1 X4input2 = 4RC4L5X2

Y1input1 = 1RC4L5Y1 Y1input2 = 1RC4L5Y2
Y2input1 = 2RC4L5Y1 Y2input2 = 2RC4L5Y2
Y3input1 = 3RC4L5Y1 Y3input2 = 3RC4L5Y2
Y4input1 = 4RC4L5Y1 Y4input2 = 4RC4L5Y2

transv. conn. : M
Switch(RC4L5B1) = 000-01-1-0-000

Board 69 Board num RC4L5B2 CRATE 4 R Slot = 9

X1input1 = 1RC4L5X3 X1input2 = 1RC4L5X4
X2input1 = 2RC4L5X3 X2input2 = 2RC4L5X4
X3input1 = 3RC4L5X3 X3input2 = 3RC4L5X4
X4input1 = 4RC4L5X3 X4input2 = 4RC4L5X4

Y1input1 = NONE Y1input2 = NONE
Y2input1 = NONE Y2input2 = NONE
Y3input1 = NONE Y3input2 = NONE
Y4input1 = NONE Y4input2 = NONE

transv. conn. : F
Switch(RC4L5B2) = 000-10-0-0-000

Board 70 Board num RC4L6B1 CRATE 4 R Slot = 10

X1input1 = 1RC4L6X1 X1input2 = 1RC4L6X2
X2input1 = 2RC4L6X1 X2input2 = 2RC4L6X2
X3input1 = 3RC4L6X1 X3input2 = 3RC4L6X2
X4input1 = 4RC4L6X1 X4input2 = 4RC4L6X2

Y1input1 = 1RC4L6Y1 Y1input2 = 1RC4L6Y2
Y2input1 = 2RC4L6Y1 Y2input2 = 2RC4L6Y2
Y3input1 = 3RC4L6Y1 Y3input2 = 3RC4L6Y2
Y4input1 = 4RC4L6Y1 Y4input2 = 4RC4L6Y2

transv. conn. : M
Switch(RC4L6B1) = 000-01-1-0-000

Board 71 Board num RC4L6B2 CRATE 4 R Slot = 11

X1input1 = 1RC4L6X3 X1input2 = 1RC4L6X4
X2input1 = 2RC4L6X3 X2input2 = 2RC4L6X4
X3input1 = 3RC4L6X3 X3input2 = 3RC4L6X4
X4input1 = 4RC4L6X3 X4input2 = 4RC4L6X4

Y1input1 = NONE Y1input2 = NONE
Y2input1 = NONE Y2input2 = NONE
Y3input1 = NONE Y3input2 = NONE
Y4input1 = NONE Y4input2 = NONE

transv. conn. : F
Switch(RC4L6B2) = 000-10-0-0-000

Board 72 Board num RC4L7B1 CRATE 4 R Slot = 12

X1input1 = 1RC4L7X1 X1input2 = 1RC4L7X2
X2input1 = 2RC4L7X1 X2input2 = 2RC4L7X2
X3input1 = 3RC4L7X1 X3input2 = 3RC4L7X2
X4input1 = 4RC4L7X1 X4input2 = 4RC4L7X2

Y1input1 = 1RC4L7Y1 Y1input2 = 1RC4L7Y2
Y2input1 = 2RC4L7Y1 Y2input2 = 2RC4L7Y2
Y3input1 = 3RC4L7Y1 Y3input2 = 3RC4L7Y2
Y4input1 = 4RC4L7Y1 Y4input2 = 4RC4L7Y2

transv. conn. : M
Switch(RC4L7B1) = 000-01-1-0-000

Board 73 Board num RC4L7B2 CRATE 4 R Slot = 13

X1input1 = 1RC4L7X3 X1input2 = 1RC4L7X4
X2input1 = 2RC4L7X3 X2input2 = 2RC4L7X4
X3input1 = 3RC4L7X3 X3input2 = 3RC4L7X4
X4input1 = 4RC4L7X3 X4input2 = 4RC4L7X4

Y1input1 = NONE Y1input2 = NONE
Y2input1 = NONE Y2input2 = NONE
Y3input1 = NONE Y3input2 = NONE
Y4input1 = NONE Y4input2 = NONE

transv. conn. : F
Switch(RC4L7B2) = 001-10-0-0-000

Board 74 Board num RC4L8B1 CRATE 4 R Slot = 14

X1input1 = 1RC4L8X1 X1input2 = 1RC4L8X2
X2input1 = 2RC4L8X1 X2input2 = 2RC4L8X2
X3input1 = 3RC4L8X1 X3input2 = 3RC4L8X2
X4input1 = 4RC4L8X1 X4input2 = 4RC4L8X2

Y1input1 = 1RC4L8Y1 Y1input2 = NONE
Y2input1 = 2RC4L8Y1 Y2input2 = NONE
Y3input1 = 3RC4L8Y1 Y3input2 = NONE
Y4input1 = 4RC4L8Y1 Y4input2 = NONE

transv. conn. : M
Switch(RC4L8B1) = 011-01-1-0-000

Board 75 Board num RC4L8B2 CRATE 4 R Slot = 15

X1input1 = 1RC4L8X3 X1input2 = 1RC4L8X4
X2input1 = 2RC4L8X3 X2input2 = 2RC4L8X4
X3input1 = 3RC4L8X3 X3input2 = 3RC4L8X4
X4input1 = 4RC4L8X3 X4input2 = 4RC4L8X4

Y1input1 = NONE Y1input2 = NONE
Y2input1 = NONE Y2input2 = NONE
Y3input1 = NONE Y3input2 = NONE
Y4input1 = NONE Y4input2 = NONE

transv. conn. : F
Switch(RC4L8B2) = 111-10-0-0-000

Board 76 Board num RC4L9B1 CRATE 4 R Slot = 16

X1input1 = 1RC4L9X1 X1input2 = 1RC4L9X2
X2input1 = 2RC4L9X1 X2input2 = 2RC4L9X2
X3input1 = 3RC4L9X1 X3input2 = 3RC4L9X2
X4input1 = 4RC4L9X1 X4input2 = 4RC4L9X2

Y1input1 = 1RC4L9Y1 Y1input2 = NONE
Y2input1 = 2RC4L9Y1 Y2input2 = NONE
Y3input1 = 3RC4L9Y1 Y3input2 = NONE
Y4input1 = 4RC4L9Y1 Y4input2 = NONE

transv. conn. NONE
Switch(RC4L9B1) = 110-01-1-0-001

Board 77 Board num RC5L1B1 CRATE 5 R Slot = 1

X1input1 = 1RC5L1X1 X1input2 = 1RC5L1X2
X2input1 = 2RC5L1X1 X2input2 = 2RC5L1X2
X3input1 = 3RC5L1X1 X3input2 = 3RC5L1X2
X4input1 = 4RC5L1X1 X4input2 = 4RC5L1X2

Y1input1 = 1RC5L1Y1 Y1input2 = NONE
Y2input1 = 2RC5L1Y1 Y2input2 = NONE
Y3input1 = 3RC5L1Y1 Y3input2 = NONE
Y4input1 = 4RC5L1Y1 Y4input2 = NONE

transv. conn. NONE
Switch(RC5L1B1) = 011-10-1-0-100

Board 78 Board num RC5L2B1 CRATE 5 R Slot = 2

X1input1 = 1RC5L2X1 X1input2 = 1RC5L2X2
X2input1 = 2RC5L2X1 X2input2 = 2RC5L2X2
X3input1 = 3RC5L2X1 X3input2 = 3RC5L2X2
X4input1 = 4RC5L2X1 X4input2 = 4RC5L2X2

Y1input1 = 1RC5L2Y1 Y1input2 = NONE
Y2input1 = 2RC5L2Y1 Y2input2 = NONE
Y3input1 = 3RC5L2Y1 Y3input2 = NONE
Y4input1 = 4RC5L2Y1 Y4input2 = NONE

transv. conn. : M
Switch(RC5L2B1) = 111-01-1-0-000

Board 79 Board num RC5L2B2 CRATE 5 R Slot = 3

X1input1 = 1RC5L2X3 X1input2 = 1RC5L2X4
X2input1 = 2RC5L2X3 X2input2 = 2RC5L2X4
X3input1 = 3RC5L2X3 X3input2 = 3RC5L2X4
X4input1 = 4RC5L2X3 X4input2 = 4RC5L2X4

Y1input1 = NONE Y1input2 = NONE
Y2input1 = NONE Y2input2 = NONE
Y3input1 = NONE Y3input2 = NONE
Y4input1 = NONE Y4input2 = NONE

transv. conn. : F
Switch(RC5L2B2) = 110-10-0-0-000

Board 80 Board num RC5L3B1 CRATE 5 R Slot = 4

X1input1 = 1RC5L3X1 X1input2 = 1RC5L3X2
X2input1 = 2RC5L3X1 X2input2 = 2RC5L3X2
X3input1 = 3RC5L3X1 X3input2 = 3RC5L3X2
X4input1 = 4RC5L3X1 X4input2 = 4RC5L3X2

Y1input1 = 1RC5L3Y1 Y1input2 = 1RC5L3Y2
Y2input1 = 2RC5L3Y1 Y2input2 = 2RC5L3Y2
Y3input1 = 3RC5L3Y1 Y3input2 = 3RC5L3Y2
Y4input1 = 4RC5L3Y1 Y4input2 = 4RC5L3Y2

transv. conn. : M
Switch(RC5L3B1) = 100-01-1-0-000

Board 81 Board num RC5L3B2 CRATE 5 R Slot = 5

X1input1 = 1RC5L3X3 X1input2 = 1RC5L3X4
X2input1 = 2RC5L3X3 X2input2 = 2RC5L3X4
X3input1 = 3RC5L3X3 X3input2 = 3RC5L3X4
X4input1 = 4RC5L3X3 X4input2 = 4RC5L3X4

Y1input1 = NONE Y1input2 = NONE
Y2input1 = NONE Y2input2 = NONE
Y3input1 = NONE Y3input2 = NONE
Y4input1 = NONE Y4input2 = NONE

transv. conn. : F
Switch(RC5L3B2) = 000-10-0-0-000

Board 82 Board num RC5L4B1 CRATE 5 R Slot = 6

X1input1 = 1RC5L4X1 X1input2 = 1RC5L4X2
X2input1 = 2RC5L4X1 X2input2 = 2RC5L4X2
X3input1 = 3RC5L4X1 X3input2 = 3RC5L4X2
X4input1 = 4RC5L4X1 X4input2 = 4RC5L4X2

Y1input1 = 1RC5L4Y1 Y1input2 = 1RC5L4Y2
Y2input1 = 2RC5L4Y1 Y2input2 = 2RC5L4Y2
Y3input1 = 3RC5L4Y1 Y3input2 = 3RC5L4Y2
Y4input1 = 4RC5L4Y1 Y4input2 = 4RC5L4Y2

transv. conn. : M
Switch(RC5L4B1) = 000-01-1-0-000

Board 83 Board num RC5L4B2 CRATE 5 R Slot = 7

X1input1 = 1RC5L4X3 X1input2 = 1RC5L4X4
X2input1 = 2RC5L4X3 X2input2 = 2RC5L4X4
X3input1 = 3RC5L4X3 X3input2 = 3RC5L4X4
X4input1 = 4RC5L4X3 X4input2 = 4RC5L4X4

Y1input1 = NONE Y1input2 = NONE
Y2input1 = NONE Y2input2 = NONE
Y3input1 = NONE Y3input2 = NONE
Y4input1 = NONE Y4input2 = NONE

transv. conn. : F
Switch(RC5L4B2) = 000-10-0-0-000

Board 84 Board num RC5L5B1 CRATE 5 R Slot = 8

X1input1 = 1RC5L5X1 X1input2 = 1RC5L5X2
X2input1 = 2RC5L5X1 X2input2 = 2RC5L5X2
X3input1 = 3RC5L5X1 X3input2 = 3RC5L5X2
X4input1 = 4RC5L5X1 X4input2 = 4RC5L5X2

Y1input1 = 1RC5L5Y1 Y1input2 = 1RC5L5Y2
Y2input1 = 2RC5L5Y1 Y2input2 = 2RC5L5Y2
Y3input1 = 3RC5L5Y1 Y3input2 = 3RC5L5Y2
Y4input1 = 4RC5L5Y1 Y4input2 = 4RC5L5Y2

transv. conn. : M
Switch(RC5L5B1) = 000-01-1-0-000

Board 85 Board num RC5L5B2 CRATE 5 R Slot = 9

X1input1 = 1RC5L5X3 X1input2 = 1RC5L5X4
X2input1 = 2RC5L5X3 X2input2 = 2RC5L5X4
X3input1 = 3RC5L5X3 X3input2 = 3RC5L5X4
X4input1 = 4RC5L5X3 X4input2 = 4RC5L5X4

Y1input1 = NONE Y1input2 = NONE
Y2input1 = NONE Y2input2 = NONE
Y3input1 = NONE Y3input2 = NONE
Y4input1 = NONE Y4input2 = NONE

transv. conn. : F
Switch(RC5L5B2) = 000-10-0-0-000

Board 86 Board num RC5L6B1 CRATE 5 R Slot = 10

X1input1 = 1RC5L6X1 X1input2 = 1RC5L6X2
X2input1 = 2RC5L6X1 X2input2 = 2RC5L6X2
X3input1 = 3RC5L6X1 X3input2 = 3RC5L6X2
X4input1 = 4RC5L6X1 X4input2 = 4RC5L6X2

Y1input1 = 1RC5L6Y1 Y1input2 = 1RC5L6Y2
Y2input1 = 2RC5L6Y1 Y2input2 = 2RC5L6Y2
Y3input1 = 3RC5L6Y1 Y3input2 = 3RC5L6Y2
Y4input1 = 4RC5L6Y1 Y4input2 = 4RC5L6Y2

transv. conn. : M
Switch(RC5L6B1) = 000-01-1-0-000

Board 87 Board num RC5L6B2 CRATE 5 R Slot = 11

X1input1 = 1RC5L6X3 X1input2 = 1RC5L6X4
X2input1 = 2RC5L6X3 X2input2 = 2RC5L6X4
X3input1 = 3RC5L6X3 X3input2 = 3RC5L6X4
X4input1 = 4RC5L6X3 X4input2 = 4RC5L6X4

Y1input1 = NONE Y1input2 = NONE
Y2input1 = NONE Y2input2 = NONE
Y3input1 = NONE Y3input2 = NONE
Y4input1 = NONE Y4input2 = NONE

transv. conn. : F
Switch(RC5L6B2) = 000-10-0-0-000

Board 88 Board num RC5L7B1 CRATE 5 R Slot = 12

X1input1 = 1RC5L7X1 X1input2 = 1RC5L7X2
X2input1 = 2RC5L7X1 X2input2 = 2RC5L7X2
X3input1 = 3RC5L7X1 X3input2 = 3RC5L7X2
X4input1 = 4RC5L7X1 X4input2 = 4RC5L7X2

Y1input1 = 1RC5L7Y1 Y1input2 = 1RC5L7Y2
Y2input1 = 2RC5L7Y1 Y2input2 = 2RC5L7Y2
Y3input1 = 3RC5L7Y1 Y3input2 = 3RC5L7Y2
Y4input1 = 4RC5L7Y1 Y4input2 = 4RC5L7Y2

transv. conn. : M
Switch(RC5L7B1) = 000-01-1-0-000

Board 89 Board num RC5L7B2 CRATE 5 R Slot = 13

X1input1 = 1RC5L7X3 X1input2 = 1RC5L7X4
X2input1 = 2RC5L7X3 X2input2 = 2RC5L7X4
X3input1 = 3RC5L7X3 X3input2 = 3RC5L7X4
X4input1 = 4RC5L7X3 X4input2 = 4RC5L7X4

Y1input1 = NONE Y1input2 = NONE
Y2input1 = NONE Y2input2 = NONE
Y3input1 = NONE Y3input2 = NONE
Y4input1 = NONE Y4input2 = NONE

transv. conn. : F
Switch(RC5L7B2) = 001-10-0-0-000

Board 90 Board num RC5L8B1 CRATE 5 R Slot = 14

X1input1 = 1RC5L8X1 X1input2 = 1RC5L8X2
X2input1 = 2RC5L8X1 X2input2 = 2RC5L8X2
X3input1 = 3RC5L8X1 X3input2 = 3RC5L8X2
X4input1 = 4RC5L8X1 X4input2 = 4RC5L8X2

Y1input1 = 1RC5L8Y1 Y1input2 = NONE
Y2input1 = 2RC5L8Y1 Y2input2 = NONE
Y3input1 = 3RC5L8Y1 Y3input2 = NONE
Y4input1 = 4RC5L8Y1 Y4input2 = NONE

transv. conn. : M
Switch(RC5L8B1) = 011-01-1-0-000

Board 91 Board num RC5L8B2 CRATE 5 R Slot = 15

X1input1 = 1RC5L8X3 X1input2 = 1RC5L8X4
X2input1 = 2RC5L8X3 X2input2 = 2RC5L8X4
X3input1 = 3RC5L8X3 X3input2 = 3RC5L8X4
X4input1 = 4RC5L8X3 X4input2 = 4RC5L8X4

Y1input1 = NONE Y1input2 = NONE
Y2input1 = NONE Y2input2 = NONE
Y3input1 = NONE Y3input2 = NONE
Y4input1 = NONE Y4input2 = NONE

transv. conn. : F
Switch(RC5L8B2) = 111-10-0-0-000

Board 92 Board num RC5L9B1 CRATE 5 R Slot = 16

X1input1 = 1RC5L9X1 X1input2 = 1RC5L9X2
X2input1 = 2RC5L9X1 X2input2 = 2RC5L9X2
X3input1 = 3RC5L9X1 X3input2 = 3RC5L9X2
X4input1 = 4RC5L9X1 X4input2 = 4RC5L9X2

Y1input1 = 1RC5L9Y1 Y1input2 = NONE
Y2input1 = 2RC5L9Y1 Y2input2 = NONE
Y3input1 = 3RC5L9Y1 Y3input2 = NONE
Y4input1 = 4RC5L9Y1 Y4input2 = NONE

transv. conn. NONE
Switch(RC5L9B1) = 110-01-1-0-001

Board 93 Board num RC6L1B1 CRATE 6 R Slot = 1

X1input1 = 1RC6L1X1 X1input2 = 1RC6L1X2
X2input1 = 2RC6L1X1 X2input2 = 2RC6L1X2
X3input1 = 3RC6L1X1 X3input2 = 3RC6L1X2
X4input1 = 4RC6L1X1 X4input2 = 4RC6L1X2

Y1input1 = 1RC6L1Y1 Y1input2 = NONE
Y2input1 = 2RC6L1Y1 Y2input2 = NONE
Y3input1 = 3RC6L1Y1 Y3input2 = NONE
Y4input1 = 4RC6L1Y1 Y4input2 = NONE

transv. conn. NONE
Switch(RC6L1B1) = 011-10-1-0-100

Board 94 Board num RC6L2B1 CRATE 6 R Slot = 2

X1input1 = 1RC6L2X1 X1input2 = 1RC6L2X2
X2input1 = 2RC6L2X1 X2input2 = 2RC6L2X2
X3input1 = 3RC6L2X1 X3input2 = 3RC6L2X2
X4input1 = 4RC6L2X1 X4input2 = 4RC6L2X2

Y1input1 = 1RC6L2Y1 Y1input2 = NONE
Y2input1 = 2RC6L2Y1 Y2input2 = NONE
Y3input1 = 3RC6L2Y1 Y3input2 = NONE
Y4input1 = 4RC6L2Y1 Y4input2 = NONE

transv. conn. : M
Switch(RC6L2B1) = 111-01-1-0-000

Board 95 Board num RC6L2B2 CRATE 6 R Slot = 3

X1input1 = 1RC6L2X3 X1input2 = 1RC6L2X4
X2input1 = 2RC6L2X3 X2input2 = 2RC6L2X4
X3input1 = 3RC6L2X3 X3input2 = 3RC6L2X4
X4input1 = 4RC6L2X3 X4input2 = 4RC6L2X4

Y1input1 = NONE Y1input2 = NONE
Y2input1 = NONE Y2input2 = NONE
Y3input1 = NONE Y3input2 = NONE
Y4input1 = NONE Y4input2 = NONE

transv. conn. : F
Switch(RC6L2B2) = 111-10-0-0-000

Board 96 Board num RC6L3B1 CRATE 6 R Slot = 4

X1input1 = 1RC6L3X1 X1input2 = 1RC6L3X2
X2input1 = 2RC6L3X1 X2input2 = 2RC6L3X2
X3input1 = 3RC6L3X1 X3input2 = 3RC6L3X2
X4input1 = 4RC6L3X1 X4input2 = 4RC6L3X2

Y1input1 = 1RC6L3Y1 Y1input2 = NONE
Y2input1 = 2RC6L3Y1 Y2input2 = NONE
Y3input1 = 3RC6L3Y1 Y3input2 = NONE
Y4input1 = 4RC6L3Y1 Y4input2 = NONE

transv. conn. : M
Switch(RC6L3B1) = 111-01-1-0-000

Board 97 Board num RC6L3B2 CRATE 6 R Slot = 5

X1input1 = 1RC6L3X3 X1input2 = 1RC6L3X4
X2input1 = 2RC6L3X3 X2input2 = 2RC6L3X4
X3input1 = 3RC6L3X3 X3input2 = 3RC6L3X4
X4input1 = 4RC6L3X3 X4input2 = 4RC6L3X4

Y1input1 = NONE Y1input2 = NONE
Y2input1 = NONE Y2input2 = NONE
Y3input1 = NONE Y3input2 = NONE
Y4input1 = NONE Y4input2 = NONE

transv. conn. : F
Switch(RC6L3B2) = 111-10-0-0-000

Board 98 Board num RC6L4B1 CRATE 6 R Slot = 6

X1input1 = 1RC6L4X1 X1input2 = 1RC6L4X2
X2input1 = 2RC6L4X1 X2input2 = 2RC6L4X2
X3input1 = 3RC6L4X1 X3input2 = 3RC6L4X2
X4input1 = 4RC6L4X1 X4input2 = 4RC6L4X2

Y1input1 = 1RC6L4Y1 Y1input2 = NONE
Y2input1 = 2RC6L4Y1 Y2input2 = NONE
Y3input1 = 3RC6L4Y1 Y3input2 = NONE
Y4input1 = 4RC6L4Y1 Y4input2 = NONE

transv. conn. : M
Switch(RC6L4B1) = 111-01-1-0-000

Board 99 Board num RC6L4B2 CRATE 6 R Slot = 7

X1input1 = 1RC6L4X3 X1input2 = 1RC6L4X4
X2input1 = 2RC6L4X3 X2input2 = 2RC6L4X4
X3input1 = 3RC6L4X3 X3input2 = 3RC6L4X4
X4input1 = 4RC6L4X3 X4input2 = 4RC6L4X4

Y1input1 = NONE Y1input2 = NONE
Y2input1 = NONE Y2input2 = NONE
Y3input1 = NONE Y3input2 = NONE
Y4input1 = NONE Y4input2 = NONE

transv. conn. : F
Switch(RC6L4B2) = 111-10-0-0-000

Board 100 Board num RC6L5B1 CRATE 6 R Slot = 8

X1input1 = 1RC6L5X1 X1input2 = 1RC6L5X2
X2input1 = 2RC6L5X1 X2input2 = 2RC6L5X2
X3input1 = 3RC6L5X1 X3input2 = 3RC6L5X2
X4input1 = 4RC6L5X1 X4input2 = 4RC6L5X2

Y1input1 = 1RC6L5Y1 Y1input2 = NONE
Y2input1 = 2RC6L5Y1 Y2input2 = NONE
Y3input1 = 3RC6L5Y1 Y3input2 = NONE
Y4input1 = 4RC6L5Y1 Y4input2 = NONE

transv. conn. : M
Switch(RC6L5B1) = 111-01-1-0-000

Board 101 Board num RC6L5B2 CRATE 6 R Slot = 9

X1input1 = 1RC6L5X3 X1input2 = 1RC6L5X4
X2input1 = 2RC6L5X3 X2input2 = 2RC6L5X4
X3input1 = 3RC6L5X3 X3input2 = 3RC6L5X4
X4input1 = 4RC6L5X3 X4input2 = 4RC6L5X4

Y1input1 = NONE Y1input2 = NONE
Y2input1 = NONE Y2input2 = NONE
Y3input1 = NONE Y3input2 = NONE
Y4input1 = NONE Y4input2 = NONE

transv. conn. : F
Switch(RC6L5B2) = 111-10-0-0-000

Board 102 Board num RC6L6B1 CRATE 6 R Slot = 10

X1input1 = 1RC6L6X1 X1input2 = 1RC6L6X2
X2input1 = 2RC6L6X1 X2input2 = 2RC6L6X2
X3input1 = 3RC6L6X1 X3input2 = 3RC6L6X2
X4input1 = 4RC6L6X1 X4input2 = 4RC6L6X2

Y1input1 = 1RC6L6Y1 Y1input2 = NONE
Y2input1 = 2RC6L6Y1 Y2input2 = NONE
Y3input1 = 3RC6L6Y1 Y3input2 = NONE
Y4input1 = 4RC6L6Y1 Y4input2 = NONE

transv. conn. : M
Switch(RC6L6B1) = 111-01-1-0-000

Board 103 Board num RC6L6B2 CRATE 6 R Slot = 11

X1input1 = 1RC6L6X3 X1input2 = 1RC6L6X4
X2input1 = 2RC6L6X3 X2input2 = 2RC6L6X4
X3input1 = 3RC6L6X3 X3input2 = 3RC6L6X4
X4input1 = 4RC6L6X3 X4input2 = 4RC6L6X4

Y1input1 = NONE Y1input2 = NONE
Y2input1 = NONE Y2input2 = NONE
Y3input1 = NONE Y3input2 = NONE
Y4input1 = NONE Y4input2 = NONE

transv. conn. : F
Switch(RC6L6B2) = 111-10-0-0-000

Board 104 Board num RC6L7B1 CRATE 6 R Slot = 12

X1input1 = 1RC6L7X1 X1input2 = 1RC6L7X2
X2input1 = 2RC6L7X1 X2input2 = 2RC6L7X2
X3input1 = 3RC6L7X1 X3input2 = 3RC6L7X2
X4input1 = 4RC6L7X1 X4input2 = 4RC6L7X2

Y1input1 = 1RC6L7Y1 Y1input2 = NONE
Y2input1 = 2RC6L7Y1 Y2input2 = NONE
Y3input1 = 3RC6L7Y1 Y3input2 = NONE
Y4input1 = 4RC6L7Y1 Y4input2 = NONE

transv. conn. : M
Switch(RC6L7B1) = 111-01-1-0-000

Board 105 Board num RC6L7B2 CRATE 6 R Slot = 13

X1input1 = 1RC6L7X3 X1input2 = 1RC6L7X4
X2input1 = 2RC6L7X3 X2input2 = 2RC6L7X4
X3input1 = 3RC6L7X3 X3input2 = 3RC6L7X4
X4input1 = 4RC6L7X3 X4input2 = 4RC6L7X4

Y1input1 = NONE Y1input2 = NONE
Y2input1 = NONE Y2input2 = NONE
Y3input1 = NONE Y3input2 = NONE
Y4input1 = NONE Y4input2 = NONE

transv. conn. : F
Switch(RC6L7B2) = 111-10-0-0-000

Board 106 Board num RC6L8B1 CRATE 6 R Slot = 14

X1input1 = 1RC6L8X1 X1input2 = 1RC6L8X2
X2input1 = 2RC6L8X1 X2input2 = 2RC6L8X2
X3input1 = 3RC6L8X1 X3input2 = 3RC6L8X2
X4input1 = 4RC6L8X1 X4input2 = 4RC6L8X2

Y1input1 = 1RC6L8Y1 Y1input2 = NONE
Y2input1 = 2RC6L8Y1 Y2input2 = NONE
Y3input1 = 3RC6L8Y1 Y3input2 = NONE
Y4input1 = 4RC6L8Y1 Y4input2 = NONE

transv. conn. : M
Switch(RC6L8B1) = 111-01-1-0-000

Board 107 Board num RC6L8B2 CRATE 6 R Slot = 15

X1input1 = 1RC6L8X3 X1input2 = 1RC6L8X4
X2input1 = 2RC6L8X3 X2input2 = 2RC6L8X4
X3input1 = 3RC6L8X3 X3input2 = 3RC6L8X4
X4input1 = 4RC6L8X3 X4input2 = 4RC6L8X4

Y1input1 = NONE Y1input2 = NONE
Y2input1 = NONE Y2input2 = NONE
Y3input1 = NONE Y3input2 = NONE
Y4input1 = NONE Y4input2 = NONE

transv. conn. : F
Switch(RC6L8B2) = 111-10-0-0-000

Board 108 Board num RC6L9B1 CRATE 6 R Slot = 16

X1input1 = 1RC6L9X1 X1input2 = 1RC6L9X2
X2input1 = 2RC6L9X1 X2input2 = 2RC6L9X2
X3input1 = 3RC6L9X1 X3input2 = 3RC6L9X2
X4input1 = 4RC6L9X1 X4input2 = 4RC6L9X2

Y1input1 = 1RC6L9Y1 Y1input2 = NONE
Y2input1 = 2RC6L9Y1 Y2input2 = NONE
Y3input1 = 3RC6L9Y1 Y3input2 = NONE
Y4input1 = 4RC6L9Y1 Y4input2 = NONE

transv. conn. NONE
Switch(RC6L9B1) = 110-01-1-0-001

Board 109 Board num RC7L1B1 CRATE 7 R Slot = 1

X1input1 = 1RC7L1X1 X1input2 = 1RC7L1X2
X2input1 = 2RC7L1X1 X2input2 = 2RC7L1X2
X3input1 = 3RC7L1X1 X3input2 = 3RC7L1X2
X4input1 = 4RC7L1X1 X4input2 = 4RC7L1X2

Y1input1 = 1RC7L1Y1 Y1input2 = 1RC7L1Y2
Y2input1 = 2RC7L1Y1 Y2input2 = 2RC7L1Y2
Y3input1 = 3RC7L1Y1 Y3input2 = 3RC7L1Y2
Y4input1 = 4RC7L1Y1 Y4input2 = 4RC7L1Y2

transv. conn. NONE
Switch(RC7L1B1) = 000-10-1-0-100

Board 110 Board num RC7L2B1 CRATE 7 R Slot = 2

X1input1 = 1RC7L2X1 X1input2 = 1RC7L2X2
X2input1 = 2RC7L2X1 X2input2 = 2RC7L2X2
X3input1 = 3RC7L2X1 X3input2 = 3RC7L2X2
X4input1 = 4RC7L2X1 X4input2 = 4RC7L2X2

Y1input1 = 1RC7L2Y1 Y1input2 = 1RC7L2Y2
Y2input1 = 2RC7L2Y1 Y2input2 = 2RC7L2Y2
Y3input1 = 3RC7L2Y1 Y3input2 = 3RC7L2Y2
Y4input1 = 4RC7L2Y1 Y4input2 = 4RC7L2Y2

transv. conn. NONE
Switch(RC7L2B1) = 000-11-1-0-000

Board 111 Board num RC7L3B1 CRATE 7 R Slot = 3

X1input1 = 1RC7L3X1 X1input2 = 1RC7L3X2
X2input1 = 2RC7L3X1 X2input2 = 2RC7L3X2
X3input1 = 3RC7L3X1 X3input2 = 3RC7L3X2
X4input1 = 4RC7L3X1 X4input2 = 4RC7L3X2

Y1input1 = 1RC7L3Y1 Y1input2 = 1RC7L3Y2
Y2input1 = 2RC7L3Y1 Y2input2 = 2RC7L3Y2
Y3input1 = 3RC7L3Y1 Y3input2 = 3RC7L3Y2
Y4input1 = 4RC7L3Y1 Y4input2 = 4RC7L3Y2

transv. conn. NONE
Switch(RC7L3B1) = 000-11-1-0-000

Board 112 Board num RC7L4B1 CRATE 7 R Slot = 4

X1input1 = 1RC7L4X1 X1input2 = 1RC7L4X2
X2input1 = 2RC7L4X1 X2input2 = 2RC7L4X2
X3input1 = 3RC7L4X1 X3input2 = 3RC7L4X2
X4input1 = 4RC7L4X1 X4input2 = 4RC7L4X2

Y1input1 = 1RC7L4Y1 Y1input2 = 1RC7L4Y2
Y2input1 = 2RC7L4Y1 Y2input2 = 2RC7L4Y2
Y3input1 = 3RC7L4Y1 Y3input2 = 3RC7L4Y2
Y4input1 = 4RC7L4Y1 Y4input2 = 4RC7L4Y2

transv. conn. NONE
Switch(RC7L4B1) = 000-11-1-0-000

Board 113 Board num RC7L5B1 CRATE 7 R Slot = 5

X1input1 = 1RC7L5X1 X1input2 = 1RC7L5X2
X2input1 = 2RC7L5X1 X2input2 = 2RC7L5X2
X3input1 = 3RC7L5X1 X3input2 = 3RC7L5X2
X4input1 = 4RC7L5X1 X4input2 = 4RC7L5X2

Y1input1 = 1RC7L5Y1 Y1input2 = 1RC7L5Y2
Y2input1 = 2RC7L5Y1 Y2input2 = 2RC7L5Y2
Y3input1 = 3RC7L5Y1 Y3input2 = 3RC7L5Y2
Y4input1 = 4RC7L5Y1 Y4input2 = 4RC7L5Y2

transv. conn. NONE
Switch(RC7L5B1) = 000-11-1-0-000

Board 114 Board num RC7L6B1 CRATE 7 R Slot = 6

X1input1 = 1RC7L6X1 X1input2 = 1RC7L6X2
X2input1 = 2RC7L6X1 X2input2 = 2RC7L6X2
X3input1 = 3RC7L6X1 X3input2 = 3RC7L6X2
X4input1 = 4RC7L6X1 X4input2 = 4RC7L6X2

Y1input1 = 1RC7L6Y1 Y1input2 = 1RC7L6Y2
Y2input1 = 2RC7L6Y1 Y2input2 = 2RC7L6Y2
Y3input1 = 3RC7L6Y1 Y3input2 = 3RC7L6Y2
Y4input1 = 4RC7L6Y1 Y4input2 = 4RC7L6Y2

transv. conn. NONE
Switch(RC7L6B1) = 000-11-1-0-000

Board 115 Board num RC7L7B1 CRATE 7 R Slot = 7

X1input1 = 1RC7L7X1 X1input2 = 1RC7L7X2
X2input1 = 2RC7L7X1 X2input2 = 2RC7L7X2
X3input1 = 3RC7L7X1 X3input2 = 3RC7L7X2
X4input1 = 4RC7L7X1 X4input2 = 4RC7L7X2

Y1input1 = 1RC7L7Y1 Y1input2 = 1RC7L7Y2
Y2input1 = 2RC7L7Y1 Y2input2 = 2RC7L7Y2
Y3input1 = 3RC7L7Y1 Y3input2 = 3RC7L7Y2
Y4input1 = 4RC7L7Y1 Y4input2 = 4RC7L7Y2

transv. conn. NONE
Switch(RC7L7B1) = 000-11-1-0-000

Board 116 Board num RC7L8B1 CRATE 7 R Slot = 8

X1input1 = 1RC7L8X1 X1input2 = 1RC7L8X2
X2input1 = 2RC7L8X1 X2input2 = 2RC7L8X2
X3input1 = 3RC7L8X1 X3input2 = 3RC7L8X2
X4input1 = 4RC7L8X1 X4input2 = 4RC7L8X2

Y1input1 = 1RC7L8Y1 Y1input2 = 1RC7L8Y2
Y2input1 = 2RC7L8Y1 Y2input2 = 2RC7L8Y2
Y3input1 = 3RC7L8Y1 Y3input2 = 3RC7L8Y2
Y4input1 = 4RC7L8Y1 Y4input2 = 4RC7L8Y2

transv. conn. NONE
Switch(RC7L8B1) = 000-11-1-0-000

Board 117 Board num RC7L9B1 CRATE 7 R Slot = 9

X1input1 = 1RC7L9X1 X1input2 = 1RC7L9X2
X2input1 = 2RC7L9X1 X2input2 = 2RC7L9X2
X3input1 = 3RC7L9X1 X3input2 = 3RC7L9X2
X4input1 = 4RC7L9X1 X4input2 = 4RC7L9X2

Y1input1 = 1RC7L9Y1 Y1input2 = 1RC7L9Y2
Y2input1 = 2RC7L9Y1 Y2input2 = 2RC7L9Y2
Y3input1 = 3RC7L9Y1 Y3input2 = 3RC7L9Y2
Y4input1 = 4RC7L9Y1 Y4input2 = 4RC7L9Y2

transv. conn. NONE
Switch(RC7L9B1) = 000-01-1-0-001

Board 118 Board num LC1L1B1 CRATE 1 L Slot = 1

X1input1 = 1LC1L1X1 X1input2 = 1LC1L1X2
X2input1 = 2LC1L1X1 X2input2 = 2LC1L1X2
X3input1 = 3LC1L1X1 X3input2 = 3LC1L1X2
X4input1 = 4LC1L1X1 X4input2 = 4LC1L1X2

Y1input1 = 1LC1L1Y1 Y1input2 = NONE
Y2input1 = 2LC1L1Y1 Y2input2 = NONE
Y3input1 = 3LC1L1Y1 Y3input2 = NONE
Y4input1 = 4LC1L1Y1 Y4input2 = NONE

transv. conn. NONE
Switch(LC1L1B1) = 011-10-1-0-100

Board 119 Board num LC1L2B1 CRATE 1 L Slot = 2

X1input1 = 1LC1L2X1 X1input2 = 1LC1L2X2
X2input1 = 2LC1L2X1 X2input2 = 2LC1L2X2
X3input1 = 3LC1L2X1 X3input2 = 3LC1L2X2
X4input1 = 4LC1L2X1 X4input2 = 4LC1L2X2

Y1input1 = 1LC1L2Y1 Y1input2 = NONE
Y2input1 = 2LC1L2Y1 Y2input2 = NONE
Y3input1 = 3LC1L2Y1 Y3input2 = NONE
Y4input1 = 4LC1L2Y1 Y4input2 = NONE

transv. conn. : M
Switch(LC1L2B1) = 111-01-1-0-000

Board 120 Board num LC1L2B2 CRATE 1 L Slot = 3

X1input1 = 1LC1L2X3 X1input2 = 1LC1L2X4
X2input1 = 2LC1L2X3 X2input2 = 2LC1L2X4
X3input1 = 3LC1L2X3 X3input2 = 3LC1L2X4
X4input1 = 4LC1L2X3 X4input2 = 4LC1L2X4

Y1input1 = NONE Y1input2 = NONE
Y2input1 = NONE Y2input2 = NONE
Y3input1 = NONE Y3input2 = NONE
Y4input1 = NONE Y4input2 = NONE

transv. conn. : F
Switch(LC1L2B2) = 110-10-0-0-000

Board 121 Board num LC1L3B1 CRATE 1 L Slot = 4

X1input1 = 1LC1L3X1 X1input2 = 1LC1L3X2
X2input1 = 2LC1L3X1 X2input2 = 2LC1L3X2
X3input1 = 3LC1L3X1 X3input2 = 3LC1L3X2
X4input1 = 4LC1L3X1 X4input2 = 4LC1L3X2

Y1input1 = 1LC1L3Y1 Y1input2 = 1LC1L3Y2
Y2input1 = 2LC1L3Y1 Y2input2 = 2LC1L3Y2
Y3input1 = 3LC1L3Y1 Y3input2 = 3LC1L3Y2
Y4input1 = 4LC1L3Y1 Y4input2 = 4LC1L3Y2

transv. conn. : M
Switch(LC1L3B1) = 100-01-1-0-000

Board 122 Board num LC1L3B2 CRATE 1 L Slot = 5

X1input1 = 1LC1L3X3 X1input2 = 1LC1L3X4
X2input1 = 2LC1L3X3 X2input2 = 2LC1L3X4
X3input1 = 3LC1L3X3 X3input2 = 3LC1L3X4
X4input1 = 4LC1L3X3 X4input2 = 4LC1L3X4

Y1input1 = NONE Y1input2 = NONE
Y2input1 = NONE Y2input2 = NONE
Y3input1 = NONE Y3input2 = NONE
Y4input1 = NONE Y4input2 = NONE

transv. conn. : F
Switch(LC1L3B2) = 000-10-0-0-000

Board 123 Board num LC1L4B1 CRATE 1 L Slot = 6

X1input1 = 1LC1L4X1 X1input2 = 1LC1L4X2
X2input1 = 2LC1L4X1 X2input2 = 2LC1L4X2
X3input1 = 3LC1L4X1 X3input2 = 3LC1L4X2
X4input1 = 4LC1L4X1 X4input2 = 4LC1L4X2

Y1input1 = 1LC1L4Y1 Y1input2 = 1LC1L4Y2
Y2input1 = 2LC1L4Y1 Y2input2 = 2LC1L4Y2
Y3input1 = 3LC1L4Y1 Y3input2 = 3LC1L4Y2
Y4input1 = 4LC1L4Y1 Y4input2 = 4LC1L4Y2

transv. conn. : M
Switch(LC1L4B1) = 000-01-1-0-000

Board 124 Board num LC1L4B2 CRATE 1 L Slot = 7

X1input1 = 1LC1L4X3 X1input2 = 1LC1L4X4
X2input1 = 2LC1L4X3 X2input2 = 2LC1L4X4
X3input1 = 3LC1L4X3 X3input2 = 3LC1L4X4
X4input1 = 4LC1L4X3 X4input2 = 4LC1L4X4

Y1input1 = NONE Y1input2 = NONE
Y2input1 = NONE Y2input2 = NONE
Y3input1 = NONE Y3input2 = NONE
Y4input1 = NONE Y4input2 = NONE

transv. conn. : FM
Switch(LC1L4B2) = 000-00-0-0-000

Board 125 Board num LC1L4B3 CRATE 1 L Slot = 8

X1input1 = 1LC1L4X5 X1input2 = 1LC1L4X6
X2input1 = 2LC1L4X5 X2input2 = 2LC1L4X6
X3input1 = 3LC1L4X5 X3input2 = 3LC1L4X6
X4input1 = 4LC1L4X5 X4input2 = 4LC1L4X6

Y1input1 = NONE Y1input2 = NONE
Y2input1 = NONE Y2input2 = NONE
Y3input1 = NONE Y3input2 = NONE
Y4input1 = NONE Y4input2 = NONE

transv. conn. : F
Switch(LC1L4B3) = 000-00-0-0-001

Board 126 Board num LC1L6B1 CRATE 1 L Slot = 9

X1input1 = 1LC1L6X1 X1input2 = 1LC1L6X2
X2input1 = 2LC1L6X1 X2input2 = 2LC1L6X2
X3input1 = 3LC1L6X1 X3input2 = 3LC1L6X2
X4input1 = 4LC1L6X1 X4input2 = 4LC1L6X2

Y1input1 = 1LC1L6Y1 Y1input2 = 1LC1L6Y2
Y2input1 = 2LC1L6Y1 Y2input2 = 2LC1L6Y2
Y3input1 = 3LC1L6Y1 Y3input2 = 3LC1L6Y2
Y4input1 = 4LC1L6Y1 Y4input2 = 4LC1L6Y2

transv. conn. : M
Switch(LC1L6B1) = 000-00-1-0-100

Board 127 Board num LC1L6B2 CRATE 1 L Slot = 10

X1input1 = 1LC1L6X3 X1input2 = 1LC1L6X4
X2input1 = 2LC1L6X3 X2input2 = 2LC1L6X4
X3input1 = 3LC1L6X3 X3input2 = 3LC1L6X4
X4input1 = 4LC1L6X3 X4input2 = 4LC1L6X4

Y1input1 = NONE Y1input2 = NONE
Y2input1 = NONE Y2input2 = NONE
Y3input1 = NONE Y3input2 = NONE
Y4input1 = NONE Y4input2 = NONE

transv. conn. : FM
Switch(LC1L6B2) = 000-00-0-0-000

Board 128 Board num LC1L6B3 CRATE 1 L Slot = 11

X1input1 = 1LC1L6X5 X1input2 = 1LC1L6X6
X2input1 = 2LC1L6X5 X2input2 = 2LC1L6X6
X3input1 = 3LC1L6X5 X3input2 = 3LC1L6X6
X4input1 = 4LC1L6X5 X4input2 = 4LC1L6X6

Y1input1 = NONE Y1input2 = NONE
Y2input1 = NONE Y2input2 = NONE
Y3input1 = NONE Y3input2 = NONE
Y4input1 = NONE Y4input2 = NONE

transv. conn. : F
Switch(LC1L6B3) = 000-10-0-0-000

Board 129 Board num LC1L7B1 CRATE 1 L Slot = 12

X1input1 = 1LC1L7X1 X1input2 = 1LC1L7X2
X2input1 = 2LC1L7X1 X2input2 = 2LC1L7X2
X3input1 = 3LC1L7X1 X3input2 = 3LC1L7X2
X4input1 = 4LC1L7X1 X4input2 = 4LC1L7X2

Y1input1 = 1LC1L7Y1 Y1input2 = 1LC1L7Y2
Y2input1 = 2LC1L7Y1 Y2input2 = 2LC1L7Y2
Y3input1 = 3LC1L7Y1 Y3input2 = 3LC1L7Y2
Y4input1 = 4LC1L7Y1 Y4input2 = 4LC1L7Y2

transv. conn. : M
Switch(LC1L7B1) = 000-01-1-0-000

Board 130 Board num LC1L7B2 CRATE 1 L Slot = 13

X1input1 = 1LC1L7X3 X1input2 = 1LC1L7X4
X2input1 = 2LC1L7X3 X2input2 = 2LC1L7X4
X3input1 = 3LC1L7X3 X3input2 = 3LC1L7X4
X4input1 = 4LC1L7X3 X4input2 = 4LC1L7X4

Y1input1 = NONE Y1input2 = NONE
Y2input1 = NONE Y2input2 = NONE
Y3input1 = NONE Y3input2 = NONE
Y4input1 = NONE Y4input2 = NONE

transv. conn. : F
Switch(LC1L7B2) = 001-10-0-0-000

Board 131 Board num LC1L8B1 CRATE 1 L Slot = 14

X1input1 = 1LC1L8X1 X1input2 = 1LC1L8X2
X2input1 = 2LC1L8X1 X2input2 = 2LC1L8X2
X3input1 = 3LC1L8X1 X3input2 = 3LC1L8X2
X4input1 = 4LC1L8X1 X4input2 = 4LC1L8X2

Y1input1 = 1LC1L8Y1 Y1input2 = NONE
Y2input1 = 2LC1L8Y1 Y2input2 = NONE
Y3input1 = 3LC1L8Y1 Y3input2 = NONE
Y4input1 = 4LC1L8Y1 Y4input2 = NONE

transv. conn. : M
Switch(LC1L8B1) = 011-01-1-0-000

Board 132 Board num LC1L8B2 CRATE 1 L Slot = 15

X1input1 = 1LC1L8X3 X1input2 = 1LC1L8X4
X2input1 = 2LC1L8X3 X2input2 = 2LC1L8X4
X3input1 = 3LC1L8X3 X3input2 = 3LC1L8X4
X4input1 = 4LC1L8X3 X4input2 = 4LC1L8X4

Y1input1 = NONE Y1input2 = NONE
Y2input1 = NONE Y2input2 = NONE
Y3input1 = NONE Y3input2 = NONE
Y4input1 = NONE Y4input2 = NONE

transv. conn. : F
Switch(LC1L8B2) = 111-10-0-0-000

Board 133 Board num LC1L9B1 CRATE 1 L Slot = 16

X1input1 = 1LC1L9X1 X1input2 = 1LC1L9X2
X2input1 = 2LC1L9X1 X2input2 = 2LC1L9X2
X3input1 = 3LC1L9X1 X3input2 = 3LC1L9X2
X4input1 = 4LC1L9X1 X4input2 = 4LC1L9X2

Y1input1 = 1LC1L9Y1 Y1input2 = NONE
Y2input1 = 2LC1L9Y1 Y2input2 = NONE
Y3input1 = 3LC1L9Y1 Y3input2 = NONE
Y4input1 = 4LC1L9Y1 Y4input2 = NONE

transv. conn. NONE
Switch(LC1L9B1) = 110-01-1-0-001

Board 134 Board num LC2L1B1 CRATE 2 L Slot = 1

X1input1 = 1LC2L1X1 X1input2 = 1LC2L1X2
X2input1 = 2LC2L1X1 X2input2 = 2LC2L1X2
X3input1 = 3LC2L1X1 X3input2 = 3LC2L1X2
X4input1 = 4LC2L1X1 X4input2 = 4LC2L1X2

Y1input1 = 1LC2L1Y1 Y1input2 = NONE
Y2input1 = 2LC2L1Y1 Y2input2 = NONE
Y3input1 = 3LC2L1Y1 Y3input2 = NONE
Y4input1 = 4LC2L1Y1 Y4input2 = NONE

transv. conn. NONE
Switch(LC2L1B1) = 011-10-1-0-100

Board 135 Board num LC2L2B1 CRATE 2 L Slot = 2

X1input1 = 1LC2L2X1 X1input2 = 1LC2L2X2
X2input1 = 2LC2L2X1 X2input2 = 2LC2L2X2
X3input1 = 3LC2L2X1 X3input2 = 3LC2L2X2
X4input1 = 4LC2L2X1 X4input2 = 4LC2L2X2

Y1input1 = 1LC2L2Y1 Y1input2 = NONE
Y2input1 = 2LC2L2Y1 Y2input2 = NONE
Y3input1 = 3LC2L2Y1 Y3input2 = NONE
Y4input1 = 4LC2L2Y1 Y4input2 = NONE

transv. conn. : M
Switch(LC2L2B1) = 111-01-1-0-000

Board 136 Board num LC2L2B2 CRATE 2 L Slot = 3

X1input1 = 1LC2L2X3 X1input2 = 1LC2L2X4
X2input1 = 2LC2L2X3 X2input2 = 2LC2L2X4
X3input1 = 3LC2L2X3 X3input2 = 3LC2L2X4
X4input1 = 4LC2L2X3 X4input2 = 4LC2L2X4

Y1input1 = NONE Y1input2 = NONE
Y2input1 = NONE Y2input2 = NONE
Y3input1 = NONE Y3input2 = NONE
Y4input1 = NONE Y4input2 = NONE

transv. conn. : F
Switch(LC2L2B2) = 110-10-0-0-000

Board 137 Board num LC2L3B1 CRATE 2 L Slot = 4

X1input1 = 1LC2L3X1 X1input2 = 1LC2L3X2
X2input1 = 2LC2L3X1 X2input2 = 2LC2L3X2
X3input1 = 3LC2L3X1 X3input2 = 3LC2L3X2
X4input1 = 4LC2L3X1 X4input2 = 4LC2L3X2

Y1input1 = 1LC2L3Y1 Y1input2 = 1LC2L3Y2
Y2input1 = 2LC2L3Y1 Y2input2 = 2LC2L3Y2
Y3input1 = 3LC2L3Y1 Y3input2 = 3LC2L3Y2
Y4input1 = 4LC2L3Y1 Y4input2 = 4LC2L3Y2

transv. conn. : M
Switch(LC2L3B1) = 100-01-1-0-000

Board 138 Board num LC2L3B2 CRATE 2 L Slot = 5

X1input1 = 1LC2L3X3 X1input2 = 1LC2L3X4
X2input1 = 2LC2L3X3 X2input2 = 2LC2L3X4
X3input1 = 3LC2L3X3 X3input2 = 3LC2L3X4
X4input1 = 4LC2L3X3 X4input2 = 4LC2L3X4

Y1input1 = NONE Y1input2 = NONE
Y2input1 = NONE Y2input2 = NONE
Y3input1 = NONE Y3input2 = NONE
Y4input1 = NONE Y4input2 = NONE

transv. conn. : F
Switch(LC2L3B2) = 000-10-0-0-000

Board 139 Board num LC2L4B1 CRATE 2 L Slot = 6

X1input1 = 1LC2L4X1 X1input2 = 1LC2L4X2
X2input1 = 2LC2L4X1 X2input2 = 2LC2L4X2
X3input1 = 3LC2L4X1 X3input2 = 3LC2L4X2
X4input1 = 4LC2L4X1 X4input2 = 4LC2L4X2

Y1input1 = 1LC2L4Y1 Y1input2 = 1LC2L4Y2
Y2input1 = 2LC2L4Y1 Y2input2 = 2LC2L4Y2
Y3input1 = 3LC2L4Y1 Y3input2 = 3LC2L4Y2
Y4input1 = 4LC2L4Y1 Y4input2 = 4LC2L4Y2

transv. conn. : M
Switch(LC2L4B1) = 000-01-1-0-000

Board 140 Board num LC2L4B2 CRATE 2 L Slot = 7

X1input1 = 1LC2L4X3 X1input2 = 1LC2L4X4
X2input1 = 2LC2L4X3 X2input2 = 2LC2L4X4
X3input1 = 3LC2L4X3 X3input2 = 3LC2L4X4
X4input1 = 4LC2L4X3 X4input2 = 4LC2L4X4

Y1input1 = NONE Y1input2 = NONE
Y2input1 = NONE Y2input2 = NONE
Y3input1 = NONE Y3input2 = NONE
Y4input1 = NONE Y4input2 = NONE

transv. conn. : FM
Switch(LC2L4B2) = 000-00-0-0-000

Board 141 Board num LC2L4B3 CRATE 2 L Slot = 8

X1input1 = 1LC2L4X5 X1input2 = 1LC2L4X6
X2input1 = 2LC2L4X5 X2input2 = 2LC2L4X6
X3input1 = 3LC2L4X5 X3input2 = 3LC2L4X6
X4input1 = 4LC2L4X5 X4input2 = 4LC2L4X6

Y1input1 = NONE Y1input2 = NONE
Y2input1 = NONE Y2input2 = NONE
Y3input1 = NONE Y3input2 = NONE
Y4input1 = NONE Y4input2 = NONE

transv. conn. : FM
Switch(LC2L4B3) = 000-00-0-0-000

Board 142 Board num LC2L4B4 CRATE 2 L Slot = 9

X1input1 = 1LC2L4X7 X1input2 = 1LC2L4X8
X2input1 = 2LC2L4X7 X2input2 = 2LC2L4X8
X3input1 = 3LC2L4X7 X3input2 = 3LC2L4X8
X4input1 = 4LC2L4X7 X4input2 = 4LC2L4X8

Y1input1 = NONE Y1input2 = NONE
Y2input1 = NONE Y2input2 = NONE
Y3input1 = NONE Y3input2 = NONE
Y4input1 = NONE Y4input2 = NONE

transv. conn. : F
Switch(LC2L4B4) = 000-10-0-0-000

Board 143 Board num LC2L5B1 CRATE 2 L Slot = 10

X1input1 = 1LC2L5X1 X1input2 = 1LC2L5X2
X2input1 = 2LC2L5X1 X2input2 = 2LC2L5X2
X3input1 = 3LC2L5X1 X3input2 = 3LC2L5X2
X4input1 = 4LC2L5X1 X4input2 = 4LC2L5X2

Y1input1 = NONE Y1input2 = 1LC2L5Y2
Y2input1 = NONE Y2input2 = 2LC2L5Y2
Y3input1 = NONE Y3input2 = 3LC2L5Y2
Y4input1 = NONE Y4input2 = 4LC2L5Y2

transv. conn. : M
Switch(LC2L5B1) = 000-01-1-1-000

Board 144 Board num LC2L5B2 CRATE 2 L Slot = 11

X1input1 = 1LC2L5X3 X1input2 = 1LC2L5X4
X2input1 = 2LC2L5X3 X2input2 = 2LC2L5X4
X3input1 = 3LC2L5X3 X3input2 = 3LC2L5X4
X4input1 = 4LC2L5X3 X4input2 = 4LC2L5X4

Y1input1 = NONE Y1input2 = NONE
Y2input1 = NONE Y2input2 = NONE
Y3input1 = NONE Y3input2 = NONE
Y4input1 = NONE Y4input2 = NONE

transv. conn. : FM
Switch(LC2L5B2) = 000-00-0-1-000

Board 145 Board num LC2L5B3 CRATE 2 L Slot = 12

X1input1 = 1LC2L5X5 X1input2 = 1LC2L5X6
X2input1 = 2LC2L5X5 X2input2 = 2LC2L5X6
X3input1 = 3LC2L5X5 X3input2 = 3LC2L5X6
X4input1 = 4LC2L5X5 X4input2 = 4LC2L5X6

Y1input1 = NONE Y1input2 = NONE
Y2input1 = NONE Y2input2 = NONE
Y3input1 = NONE Y3input2 = NONE
Y4input1 = NONE Y4input2 = NONE

transv. conn. : FM
Switch(LC2L5B3) = 000-00-0-1-000

Board 146 Board num LC2L5B4 CRATE 2 L Slot = 13

X1input1 = 1LC2L5X7 X1input2 = 1LC2L5X8
X2input1 = 2LC2L5X7 X2input2 = 2LC2L5X8
X3input1 = 3LC2L5X7 X3input2 = 3LC2L5X8
X4input1 = 4LC2L5X7 X4input2 = 4LC2L5X8

Y1input1 = NONE Y1input2 = NONE
Y2input1 = NONE Y2input2 = NONE
Y3input1 = NONE Y3input2 = NONE
Y4input1 = NONE Y4input2 = NONE

transv. conn. : F
Switch(LC2L5B4) = 000-10-0-1-000

Board 147 Board num LC2L6B1 CRATE 2 L Slot = 14

X1input1 = 1LC2L6X1 X1input2 = 1LC2L6X2
X2input1 = 2LC2L6X1 X2input2 = 2LC2L6X2
X3input1 = 3LC2L6X1 X3input2 = 3LC2L6X2
X4input1 = 4LC2L6X1 X4input2 = 4LC2L6X2

Y1input1 = 1LC2L6Y1 (1) Y1input2 = 1LC2L6Y2 (1)
Y2input1 = 2LC2L6Y1 (1) Y2input2 = 2LC2L6Y2 (1)
Y3input1 = 3LC2L6Y1 (1) Y3input2 = 3LC2L6Y2 (1)
Y4input1 = 4LC2L6Y1 (1) Y4input2 = 4LC2L6Y2 (1)

transv. conn. : M
Switch(LC2L6B1) = 000-01-1-0-000

Board 148 Board num LC2L6B2 CRATE 2 L Slot = 15

X1input1 = 1LC2L6X3 X1input2 = 1LC2L6X4
X2input1 = 2LC2L6X3 X2input2 = 2LC2L6X4
X3input1 = 3LC2L6X3 X3input2 = 3LC2L6X4 (1)
X4input1 = 4LC2L6X3 X4input2 = 4LC2L6X4 (1)

Y1input1 = NONE Y1input2 = NONE
Y2input1 = NONE Y2input2 = NONE
Y3input1 = NONE Y3input2 = NONE
Y4input1 = NONE Y4input2 = NONE

transv. conn. : F
Switch(LC2L6B2) = 000-00-0-0-000

Board nn Board num LIntC2-Up CRATE 2 L Slot = 16

X1input1 = NONE X1input2 = NONE
X2input1 = NONE X2input2 = NONE
X3input1 = 3LC2L6X5 (2) X3input2 = NONE
X4input1 = 4LC2L6X5 (2) X4input2 = NONE

Y1input1 = NONE Y1input2 = NONE
Y2input1 = NONE Y2input2 = NONE
Y3input1 = NONE Y3input2 = NONE
Y4input1 = NONE Y4input2 = NONE

transv. conn. NONE
Switch(LIntC2-Up) = NONE

Board nn Board num LIntC2-Dw CRATE 2-3 L Slot = 1

X1input1 = NONE X1input2 = NONE
X2input1 = NONE X2input2 = NONE
X3input1 = NONE X3input2 = 3LC2L6X4 (2)
X4input1 = NONE X4input2 = 4LC2L6X4 (2)

Y1input1 = NONE Y1input2 = NONE
Y2input1 = NONE Y2input2 = NONE
Y3input1 = NONE Y3input2 = NONE
Y4input1 = NONE Y4input2 = NONE

transv. conn. NONE
Switch(LIntC2-Dw) = NONE

Board 149 Board num LC2L6B3 CRATE 2-3 L Slot = 2

X1input1 = 1LC2L6X5 X1input2 = 1LC2L6X6
X2input1 = 2LC2L6X5 X2input2 = 2LC2L6X6
X3input1 = 3LC2L6X5 (1) X3input2 = 3LC2L6X6
X4input1 = 4LC2L6X5 (1) X4input2 = 4LC2L6X6

Y1input1 = 1LC2L6Y1 (2) Y1input2 = 1LC2L6Y2 (2)
Y2input1 = 2LC2L6Y1 (2) Y2input2 = 2LC2L6Y2 (2)
Y3input1 = 3LC2L6Y1 (2) Y3input2 = 3LC2L6Y2 (2)
Y4input1 = 4LC2L6Y1 (2) Y4input2 = 4LC2L6Y2 (2)

transv. conn. : M
Switch(LC2L6B3) = 000-00-1-0-000

Board 150 Board num LC2L6B4 CRATE 2-3 L Slot = 3

X1input1 = 1LC2L6X7 X1input2 = 1LC2L6X8
X2input1 = 2LC2L6X7 X2input2 = 2LC2L6X8
X3input1 = 3LC2L6X7 X3input2 = 3LC2L6X8
X4input1 = 4LC2L6X7 X4input2 = 4LC2L6X8

Y1input1 = NONE Y1input2 = NONE
Y2input1 = NONE Y2input2 = NONE
Y3input1 = NONE Y3input2 = NONE
Y4input1 = NONE Y4input2 = NONE

transv. conn. : F
Switch(LC2L6B4) = 000-10-0-0-000

Board 151 Board num LC2L7B1 CRATE 2-3 L Slot = 4

X1input1 = 1LC2L7X1 X1input2 = 1LC2L7X2
X2input1 = 2LC2L7X1 X2input2 = 2LC2L7X2
X3input1 = 3LC2L7X1 X3input2 = 3LC2L7X2
X4input1 = 4LC2L7X1 X4input2 = 4LC2L7X2

Y1input1 = 1LC2L7Y1 Y1input2 = 1LC2L7Y2
Y2input1 = 2LC2L7Y1 Y2input2 = 2LC2L7Y2
Y3input1 = 3LC2L7Y1 Y3input2 = 3LC2L7Y2
Y4input1 = 4LC2L7Y1 Y4input2 = 4LC2L7Y2

transv. conn. : M
Switch(LC2L7B1) = 000-01-1-0-000

Board 152 Board num LC2L7B2 CRATE 2-3 L Slot = 5

X1input1 = 1LC2L7X3 X1input2 = 1LC2L7X4
X2input1 = 2LC2L7X3 X2input2 = 2LC2L7X4
X3input1 = 3LC2L7X3 X3input2 = 3LC2L7X4
X4input1 = 4LC2L7X3 X4input2 = 4LC2L7X4

Y1input1 = NONE Y1input2 = NONE
Y2input1 = NONE Y2input2 = NONE
Y3input1 = NONE Y3input2 = NONE
Y4input1 = NONE Y4input2 = NONE

transv. conn. : F
Switch(LC2L7B2) = 001-10-0-0-000

Board 153 Board num LC2L8B1 CRATE 2-3 L Slot = 6

X1input1 = 1LC2L8X1 X1input2 = 1LC2L8X2
X2input1 = 2LC2L8X1 X2input2 = 2LC2L8X2
X3input1 = 3LC2L8X1 X3input2 = 3LC2L8X2
X4input1 = 4LC2L8X1 X4input2 = 4LC2L8X2

Y1input1 = 1LC2L8Y1 Y1input2 = NONE
Y2input1 = 2LC2L8Y1 Y2input2 = NONE
Y3input1 = 3LC2L8Y1 Y3input2 = NONE
Y4input1 = 4LC2L8Y1 Y4input2 = NONE

transv. conn. : M
Switch(LC2L8B1) = 011-01-1-0-000

Board 154 Board num LC2L8B2 CRATE 2-3 L Slot = 7

X1input1 = 1LC2L8X3 X1input2 = 1LC2L8X4
X2input1 = 2LC2L8X3 X2input2 = 2LC2L8X4
X3input1 = 3LC2L8X3 X3input2 = 3LC2L8X4
X4input1 = 4LC2L8X3 X4input2 = 4LC2L8X4

Y1input1 = NONE Y1input2 = NONE
Y2input1 = NONE Y2input2 = NONE
Y3input1 = NONE Y3input2 = NONE
Y4input1 = NONE Y4input2 = NONE

transv. conn. : F
Switch(LC2L8B2) = 111-10-0-0-000

Board 155 Board num LC2L9B1 CRATE 2-3 L Slot = 8

X1input1 = 1LC2L9X1 X1input2 = 1LC2L9X2
X2input1 = 2LC2L9X1 X2input2 = 2LC2L9X2
X3input1 = 3LC2L9X1 X3input2 = 3LC2L9X2
X4input1 = 4LC2L9X1 X4input2 = 4LC2L9X2

Y1input1 = 1LC2L9Y1 Y1input2 = NONE
Y2input1 = 2LC2L9Y1 Y2input2 = NONE
Y3input1 = 3LC2L9Y1 Y3input2 = NONE
Y4input1 = 4LC2L9Y1 Y4input2 = NONE

transv. conn. NONE
Switch(LC2L9B1) = 110-01-1-0-001

Board 156 Board num LC3L1B1 CRATE 3 L Slot = 1

X1input1 = 1LC3L1X1 X1input2 = 1LC3L1X2
X2input1 = 2LC3L1X1 X2input2 = 2LC3L1X2
X3input1 = 3LC3L1X1 X3input2 = 3LC3L1X2
X4input1 = 4LC3L1X1 X4input2 = 4LC3L1X2

Y1input1 = 1LC3L1Y1 Y1input2 = NONE
Y2input1 = 2LC3L1Y1 Y2input2 = NONE
Y3input1 = 3LC3L1Y1 Y3input2 = NONE
Y4input1 = 4LC3L1Y1 Y4input2 = NONE

transv. conn. NONE
Switch(LC3L1B1) = 011-10-1-0-100

Board 157 Board num LC3L2B1 CRATE 3 L Slot = 2

X1input1 = 1LC3L2X1 X1input2 = 1LC3L2X2
X2input1 = 2LC3L2X1 X2input2 = 2LC3L2X2
X3input1 = 3LC3L2X1 X3input2 = 3LC3L2X2
X4input1 = 4LC3L2X1 X4input2 = 4LC3L2X2

Y1input1 = 1LC3L2Y1 Y1input2 = NONE
Y2input1 = 2LC3L2Y1 Y2input2 = NONE
Y3input1 = 3LC3L2Y1 Y3input2 = NONE
Y4input1 = 4LC3L2Y1 Y4input2 = NONE

transv. conn. : M
Switch(LC3L2B1) = 111-01-1-0-000

Board 158 Board num LC3L2B2 CRATE 3 L Slot = 3

X1input1 = 1LC3L2X3 X1input2 = 1LC3L2X4
X2input1 = 2LC3L2X3 X2input2 = 2LC3L2X4
X3input1 = 3LC3L2X3 X3input2 = 3LC3L2X4
X4input1 = 4LC3L2X3 X4input2 = 4LC3L2X4

Y1input1 = NONE Y1input2 = NONE
Y2input1 = NONE Y2input2 = NONE
Y3input1 = NONE Y3input2 = NONE
Y4input1 = NONE Y4input2 = NONE

transv. conn. : F
Switch(LC3L2B2) = 110-10-0-0-000

Board 159 Board num LC3L3B1 CRATE 3 L Slot = 4

X1input1 = 1LC3L3X1 X1input2 = 1LC3L3X2
X2input1 = 2LC3L3X1 X2input2 = 2LC3L3X2
X3input1 = 3LC3L3X1 X3input2 = 3LC3L3X2
X4input1 = 4LC3L3X1 X4input2 = 4LC3L3X2

Y1input1 = 1LC3L3Y1 Y1input2 = 1LC3L3Y2
Y2input1 = 2LC3L3Y1 Y2input2 = 2LC3L3Y2
Y3input1 = 3LC3L3Y1 Y3input2 = 3LC3L3Y2
Y4input1 = 4LC3L3Y1 Y4input2 = 4LC3L3Y2

transv. conn. : M
Switch(LC3L3B1) = 100-01-1-0-000

Board 160 Board num LC3L3B2 CRATE 3 L Slot = 5

X1input1 = 1LC3L3X3 X1input2 = 1LC3L3X4
X2input1 = 2LC3L3X3 X2input2 = 2LC3L3X4
X3input1 = 3LC3L3X3 X3input2 = 3LC3L3X4
X4input1 = 4LC3L3X3 X4input2 = 4LC3L3X4

Y1input1 = NONE Y1input2 = NONE
Y2input1 = NONE Y2input2 = NONE
Y3input1 = NONE Y3input2 = NONE
Y4input1 = NONE Y4input2 = NONE

transv. conn. : F
Switch(LC3L3B2) = 000-10-0-0-000

Board 161 Board num LC3L4B1 CRATE 3 L Slot = 6

X1input1 = 1LC3L4X1 X1input2 = 1LC3L4X2
X2input1 = 2LC3L4X1 X2input2 = 2LC3L4X2
X3input1 = 3LC3L4X1 X3input2 = 3LC3L4X2
X4input1 = 4LC3L4X1 X4input2 = 4LC3L4X2

Y1input1 = 1LC3L4Y1 Y1input2 = 1LC3L4Y2
Y2input1 = 2LC3L4Y1 Y2input2 = 2LC3L4Y2
Y3input1 = 3LC3L4Y1 Y3input2 = 3LC3L4Y2
Y4input1 = 4LC3L4Y1 Y4input2 = 4LC3L4Y2

transv. conn. : M
Switch(LC3L4B1) = 000-01-1-0-000

Board 162 Board num LC3L4B2 CRATE 3 L Slot = 7

X1input1 = 1LC3L4X3 X1input2 = 1LC3L4X4
X2input1 = 2LC3L4X3 X2input2 = 2LC3L4X4
X3input1 = 3LC3L4X3 X3input2 = 3LC3L4X4
X4input1 = 4LC3L4X3 X4input2 = 4LC3L4X4

Y1input1 = NONE Y1input2 = NONE
Y2input1 = NONE Y2input2 = NONE
Y3input1 = NONE Y3input2 = NONE
Y4input1 = NONE Y4input2 = NONE

transv. conn. : FM
Switch(LC3L4B2) = 000-00-0-0-000

Board 163 Board num LC3L4B3 CRATE 3 L Slot = 8

X1input1 = 1LC3L4X5 X1input2 = 1LC3L4X6
X2input1 = 2LC3L4X5 X2input2 = 2LC3L4X6
X3input1 = 3LC3L4X5 X3input2 = 3LC3L4X6
X4input1 = 4LC3L4X5 X4input2 = 4LC3L4X6

Y1input1 = NONE Y1input2 = NONE
Y2input1 = NONE Y2input2 = NONE
Y3input1 = NONE Y3input2 = NONE
Y4input1 = NONE Y4input2 = NONE

transv. conn. : FM
Switch(LC3L4B3) = 000-00-0-0-000

Board 164 Board num LC3L4B4 CRATE 3 L Slot = 9

X1input1 = 1LC3L4X7 X1input2 = 1LC3L4X8
X2input1 = 2LC3L4X7 X2input2 = 2LC3L4X8
X3input1 = 3LC3L4X7 X3input2 = 3LC3L4X8
X4input1 = 4LC3L4X7 X4input2 = 4LC3L4X8

Y1input1 = NONE Y1input2 = NONE
Y2input1 = NONE Y2input2 = NONE
Y3input1 = NONE Y3input2 = NONE
Y4input1 = NONE Y4input2 = NONE

transv. conn. : F
Switch(LC3L4B4) = 000-10-0-0-000

Board 165 Board num LC3L5B1 CRATE 3 L Slot = 10

X1input1 = 1LC3L5X1 X1input2 = 1LC3L5X2
X2input1 = 2LC3L5X1 X2input2 = 2LC3L5X2
X3input1 = 3LC3L5X1 X3input2 = 3LC3L5X2
X4input1 = 4LC3L5X1 X4input2 = 4LC3L5X2

Y1input1 = 1LC3L5Y1 Y1input2 = 1LC3L5Y2
Y2input1 = 2LC3L5Y1 Y2input2 = 2LC3L5Y2
Y3input1 = 3LC3L5Y1 Y3input2 = 3LC3L5Y2
Y4input1 = 4LC3L5Y1 Y4input2 = 4LC3L5Y2

transv. conn. : M
Switch(LC3L5B1) = 000-01-1-0-000

Board 166 Board num LC3L5B2 CRATE 3 L Slot = 11

X1input1 = 1LC3L5X3 X1input2 = 1LC3L5X4
X2input1 = 2LC3L5X3 X2input2 = 2LC3L5X4
X3input1 = 3LC3L5X3 X3input2 = 3LC3L5X4
X4input1 = 4LC3L5X3 X4input2 = 4LC3L5X4

Y1input1 = NONE Y1input2 = NONE
Y2input1 = NONE Y2input2 = NONE
Y3input1 = NONE Y3input2 = NONE
Y4input1 = NONE Y4input2 = NONE

transv. conn. : FM
Switch(LC3L5B2) = 000-00-0-0-000

Board 167 Board num LC3L5B3 CRATE 3 L Slot = 12

X1input1 = 1LC3L5X5 X1input2 = 1LC3L5X6
X2input1 = 2LC3L5X5 X2input2 = 2LC3L5X6
X3input1 = 3LC3L5X5 X3input2 = 3LC3L5X6
X4input1 = 4LC3L5X5 X4input2 = 4LC3L5X6

Y1input1 = NONE Y1input2 = NONE
Y2input1 = NONE Y2input2 = NONE
Y3input1 = NONE Y3input2 = NONE
Y4input1 = NONE Y4input2 = NONE

transv. conn. : FM
Switch(LC3L5B3) = 000-00-0-0-000

Board 168 Board num LC3L5B4 CRATE 3 L Slot = 13

X1input1 = 1LC3L5X7 X1input2 = 1LC3L5X8
X2input1 = 2LC3L5X7 X2input2 = 2LC3L5X8
X3input1 = 3LC3L5X7 X3input2 = 3LC3L5X8
X4input1 = 4LC3L5X7 X4input2 = 4LC3L5X8

Y1input1 = NONE Y1input2 = NONE
Y2input1 = NONE Y2input2 = NONE
Y3input1 = NONE Y3input2 = NONE
Y4input1 = NONE Y4input2 = NONE

transv. conn. : F
Switch(LC3L5B4) = 000-10-0-0-000

Board 169 Board num LC3L6B1 CRATE 3 L Slot = 14

X1input1 = 1LC3L6X1 X1input2 = 1LC3L6X2
X2input1 = 2LC3L6X1 X2input2 = 2LC3L6X2
X3input1 = 3LC3L6X1 X3input2 = 3LC3L6X2
X4input1 = 4LC3L6X1 X4input2 = 4LC3L6X2

Y1input1 = 1LC3L6Y1 (1) Y1input2 = 1LC3L6Y2 (1)
Y2input1 = 2LC3L6Y1 (1) Y2input2 = 2LC3L6Y2 (1)
Y3input1 = 3LC3L6Y1 (1) Y3input2 = 3LC3L6Y2 (1)
Y4input1 = 4LC3L6Y1 (1) Y4input2 = 4LC3L6Y2 (1)

transv. conn. : M
Switch(LC3L6B1) = 000-01-1-0-000

Board 170 Board num LC3L6B2 CRATE 3 L Slot = 15

X1input1 = 1LC3L6X3 X1input2 = 1LC3L6X4
X2input1 = 2LC3L6X3 X2input2 = 2LC3L6X4
X3input1 = 3LC3L6X3 X3input2 = 3LC3L6X4
X4input1 = 4LC3L6X3 X4input2 = 4LC3L6X4

Y1input1 = NONE Y1input2 = NONE
Y2input1 = NONE Y2input2 = NONE
Y3input1 = NONE Y3input2 = NONE
Y4input1 = NONE Y4input2 = NONE

transv. conn. : F
Switch(LC3L6B2) = 000-00-0-0-000

Board nn Board num LIntC3-Up CRATE 3 L Slot = 16

X1input1 = NONE X1input2 = NONE
X2input1 = NONE X2input2 = NONE
X3input1 = 3LC3L6X5 (2) X3input2 = NONE
X4input1 = 4LC3L6X5 (2) X4input2 = NONE

Y1input1 = NONE Y1input2 = NONE
Y2input1 = NONE Y2input2 = NONE
Y3input1 = NONE Y3input2 = NONE
Y4input1 = NONE Y4input2 = NONE

transv. conn. NONE
Switch(LIntC3-Up) = NONE

Board nn Board num LIntC3-Dw CRATE 2-3 L Slot = 9

X1input1 = NONE X1input2 = NONE
X2input1 = NONE X2input2 = NONE
X3input1 = NONE X3input2 = 3LC3L6X4 (2)
X4input1 = NONE X4input2 = 4LC3L6X4 (2)

Y1input1 = NONE Y1input2 = NONE
Y2input1 = NONE Y2input2 = NONE
Y3input1 = NONE Y3input2 = NONE
Y4input1 = NONE Y4input2 = NONE

transv. conn. NONE
Switch(LIntC3-Dw) = NONE

Board 171 Board num LC3L6B3 CRATE 2-3 L Slot = 10

X1input1 = 1LC3L6X5 X1input2 = 1LC3L6X6
X2input1 = 2LC3L6X5 X2input2 = 2LC3L6X6
X3input1 = 3LC3L6X5 (1) X3input2 = 3LC3L6X6
X4input1 = 4LC3L6X5 (1) X4input2 = 4LC3L6X6

Y1input1 = 1LC3L6Y1 (2) Y1input2 = 1LC3L6Y2 (2)
Y2input1 = 2LC3L6Y1 (2) Y2input2 = 2LC3L6Y2 (2)
Y3input1 = 3LC3L6Y1 (2) Y3input2 = 3LC3L6Y2 (2)
Y4input1 = 4LC3L6Y1 (2) Y4input2 = 4LC3L6Y2 (2)

transv. conn. : M
Switch(LC3L6B3) = 000-00-1-0-000

Board 172 Board num LC3L6B4 CRATE 2-3 L Slot = 11

X1input1 = 1LC3L6X7 X1input2 = 1LC3L6X8
X2input1 = 2LC3L6X7 X2input2 = 2LC3L6X8
X3input1 = 3LC3L6X7 X3input2 = 3LC3L6X8
X4input1 = 4LC3L6X7 X4input2 = 4LC3L6X8

Y1input1 = NONE Y1input2 = NONE
Y2input1 = NONE Y2input2 = NONE
Y3input1 = NONE Y3input2 = NONE
Y4input1 = NONE Y4input2 = NONE

transv. conn. : F
Switch(LC3L6B4) = 000-10-0-0-000

Board 173 Board num LC3L7B1 CRATE 2-3 L Slot = 12

X1input1 = 1LC3L7X1 X1input2 = 1LC3L7X2
X2input1 = 2LC3L7X1 X2input2 = 2LC3L7X2
X3input1 = 3LC3L7X1 X3input2 = 3LC3L7X2
X4input1 = 4LC3L7X1 X4input2 = 4LC3L7X2

Y1input1 = 1LC3L7Y1 Y1input2 = 1LC3L7Y2
Y2input1 = 2LC3L7Y1 Y2input2 = 2LC3L7Y2
Y3input1 = 3LC3L7Y1 Y3input2 = 3LC3L7Y2
Y4input1 = 4LC3L7Y1 Y4input2 = 4LC3L7Y2

transv. conn. : M
Switch(LC3L7B1) = 000-01-1-0-000

Board 174 Board num LC3L7B2 CRATE 2-3 L Slot = 13

X1input1 = 1LC3L7X3 X1input2 = 1LC3L7X4
X2input1 = 2LC3L7X3 X2input2 = 2LC3L7X4
X3input1 = 3LC3L7X3 X3input2 = 3LC3L7X4
X4input1 = 4LC3L7X3 X4input2 = 4LC3L7X4

Y1input1 = NONE Y1input2 = NONE
Y2input1 = NONE Y2input2 = NONE
Y3input1 = NONE Y3input2 = NONE
Y4input1 = NONE Y4input2 = NONE

transv. conn. : F
Switch(LC3L7B2) = 001-10-0-0-000

Board 175 Board num LC3L8B1 CRATE 2-3 L Slot = 14

X1input1 = 1LC3L8X1 X1input2 = 1LC3L8X2
X2input1 = 2LC3L8X1 X2input2 = 2LC3L8X2
X3input1 = 3LC3L8X1 X3input2 = 3LC3L8X2
X4input1 = 4LC3L8X1 X4input2 = 4LC3L8X2

Y1input1 = 1LC3L8Y1 Y1input2 = NONE
Y2input1 = 2LC3L8Y1 Y2input2 = NONE
Y3input1 = 3LC3L8Y1 Y3input2 = NONE
Y4input1 = 4LC3L8Y1 Y4input2 = NONE

transv. conn. : M
Switch(LC3L8B1) = 011-01-1-0-000

Board 176 Board num LC3L8B2 CRATE 2-3 L Slot = 15

X1input1 = 1LC3L8X3 X1input2 = 1LC3L8X4
X2input1 = 2LC3L8X3 X2input2 = 2LC3L8X4
X3input1 = 3LC3L8X3 X3input2 = 3LC3L8X4
X4input1 = 4LC3L8X3 X4input2 = 4LC3L8X4

Y1input1 = NONE Y1input2 = NONE
Y2input1 = NONE Y2input2 = NONE
Y3input1 = NONE Y3input2 = NONE
Y4input1 = NONE Y4input2 = NONE

transv. conn. : F
Switch(LC3L8B2) = 111-10-0-0-000

Board 177 Board num LC3L9B1 CRATE 2-3 L Slot = 16

X1input1 = 1LC3L9X1 X1input2 = 1LC3L9X2
X2input1 = 2LC3L9X1 X2input2 = 2LC3L9X2
X3input1 = 3LC3L9X1 X3input2 = 3LC3L9X2
X4input1 = 4LC3L9X1 X4input2 = 4LC3L9X2

Y1input1 = 1LC3L9Y1 Y1input2 = NONE
Y2input1 = 2LC3L9Y1 Y2input2 = NONE
Y3input1 = 3LC3L9Y1 Y3input2 = NONE
Y4input1 = 4LC3L9Y1 Y4input2 = NONE

transv. conn. NONE
Switch(LC3L9B1) = 110-01-1-0-001

Board 178 Board num LC4L1B1 CRATE 4 L Slot = 1

X1input1 = 1LC4L1X1 X1input2 = 1LC4L1X2
X2input1 = 2LC4L1X1 X2input2 = 2LC4L1X2
X3input1 = 3LC4L1X1 X3input2 = 3LC4L1X2
X4input1 = 4LC4L1X1 X4input2 = 4LC4L1X2

Y1input1 = 1LC4L1Y1 Y1input2 = NONE
Y2input1 = 2LC4L1Y1 Y2input2 = NONE
Y3input1 = 3LC4L1Y1 Y3input2 = NONE
Y4input1 = 4LC4L1Y1 Y4input2 = NONE

transv. conn. NONE
Switch(LC4L1B1) = 011-10-1-0-100

Board 179 Board num LC4L2B1 CRATE 4 L Slot = 2

X1input1 = 1LC4L2X1 X1input2 = 1LC4L2X2
X2input1 = 2LC4L2X1 X2input2 = 2LC4L2X2
X3input1 = 3LC4L2X1 X3input2 = 3LC4L2X2
X4input1 = 4LC4L2X1 X4input2 = 4LC4L2X2

Y1input1 = 1LC4L2Y1 Y1input2 = NONE
Y2input1 = 2LC4L2Y1 Y2input2 = NONE
Y3input1 = 3LC4L2Y1 Y3input2 = NONE
Y4input1 = 4LC4L2Y1 Y4input2 = NONE

transv. conn. : M
Switch(LC4L2B1) = 111-01-1-0-000

Board 180 Board num LC4L2B2 CRATE 4 L Slot = 3

X1input1 = 1LC4L2X3 X1input2 = 1LC4L2X4
X2input1 = 2LC4L2X3 X2input2 = 2LC4L2X4
X3input1 = 3LC4L2X3 X3input2 = 3LC4L2X4
X4input1 = 4LC4L2X3 X4input2 = 4LC4L2X4

Y1input1 = NONE Y1input2 = NONE
Y2input1 = NONE Y2input2 = NONE
Y3input1 = NONE Y3input2 = NONE
Y4input1 = NONE Y4input2 = NONE

transv. conn. : F
Switch(LC4L2B2) = 110-10-0-0-000

Board 181 Board num LC4L3B1 CRATE 4 L Slot = 4

X1input1 = 1LC4L3X1 X1input2 = 1LC4L3X2
X2input1 = 2LC4L3X1 X2input2 = 2LC4L3X2
X3input1 = 3LC4L3X1 X3input2 = 3LC4L3X2
X4input1 = 4LC4L3X1 X4input2 = 4LC4L3X2

Y1input1 = 1LC4L3Y1 Y1input2 = 1LC4L3Y2
Y2input1 = 2LC4L3Y1 Y2input2 = 2LC4L3Y2
Y3input1 = 3LC4L3Y1 Y3input2 = 3LC4L3Y2
Y4input1 = 4LC4L3Y1 Y4input2 = 4LC4L3Y2

transv. conn. : M
Switch(LC4L3B1) = 100-01-1-0-000

Board 182 Board num LC4L3B2 CRATE 4 L Slot = 5

X1input1 = 1LC4L3X3 X1input2 = 1LC4L3X4
X2input1 = 2LC4L3X3 X2input2 = 2LC4L3X4
X3input1 = 3LC4L3X3 X3input2 = 3LC4L3X4
X4input1 = 4LC4L3X3 X4input2 = 4LC4L3X4

Y1input1 = NONE Y1input2 = NONE
Y2input1 = NONE Y2input2 = NONE
Y3input1 = NONE Y3input2 = NONE
Y4input1 = NONE Y4input2 = NONE

transv. conn. : F
Switch(LC4L3B2) = 000-10-0-0-000

Board 183 Board num LC4L4B1 CRATE 4 L Slot = 6

X1input1 = 1LC4L4X1 X1input2 = 1LC4L4X2
X2input1 = 2LC4L4X1 X2input2 = 2LC4L4X2
X3input1 = 3LC4L4X1 X3input2 = 3LC4L4X2
X4input1 = 4LC4L4X1 X4input2 = 4LC4L4X2

Y1input1 = 1LC4L4Y1 Y1input2 = 1LC4L4Y2
Y2input1 = 2LC4L4Y1 Y2input2 = 2LC4L4Y2
Y3input1 = 3LC4L4Y1 Y3input2 = 3LC4L4Y2
Y4input1 = 4LC4L4Y1 Y4input2 = 4LC4L4Y2

transv. conn. : M
Switch(LC4L4B1) = 000-01-1-0-000

Board 184 Board num LC4L4B2 CRATE 4 L Slot = 7

X1input1 = 1LC4L4X3 X1input2 = 1LC4L4X4
X2input1 = 2LC4L4X3 X2input2 = 2LC4L4X4
X3input1 = 3LC4L4X3 X3input2 = 3LC4L4X4
X4input1 = 4LC4L4X3 X4input2 = 4LC4L4X4

Y1input1 = NONE Y1input2 = NONE
Y2input1 = NONE Y2input2 = NONE
Y3input1 = NONE Y3input2 = NONE
Y4input1 = NONE Y4input2 = NONE

transv. conn. : F
Switch(LC4L4B2) = 000-10-0-0-000

Board 185 Board num LC4L5B1 CRATE 4 L Slot = 8

X1input1 = 1LC4L5X1 X1input2 = 1LC4L5X2
X2input1 = 2LC4L5X1 X2input2 = 2LC4L5X2
X3input1 = 3LC4L5X1 X3input2 = 3LC4L5X2
X4input1 = 4LC4L5X1 X4input2 = 4LC4L5X2

Y1input1 = 1LC4L5Y1 Y1input2 = 1LC4L5Y2
Y2input1 = 2LC4L5Y1 Y2input2 = 2LC4L5Y2
Y3input1 = 3LC4L5Y1 Y3input2 = 3LC4L5Y2
Y4input1 = 4LC4L5Y1 Y4input2 = 4LC4L5Y2

transv. conn. : M
Switch(LC4L5B1) = 000-01-1-0-000

Board 186 Board num LC4L5B2 CRATE 4 L Slot = 9

X1input1 = 1LC4L5X3 X1input2 = 1LC4L5X4
X2input1 = 2LC4L5X3 X2input2 = 2LC4L5X4
X3input1 = 3LC4L5X3 X3input2 = 3LC4L5X4
X4input1 = 4LC4L5X3 X4input2 = 4LC4L5X4

Y1input1 = NONE Y1input2 = NONE
Y2input1 = NONE Y2input2 = NONE
Y3input1 = NONE Y3input2 = NONE
Y4input1 = NONE Y4input2 = NONE

transv. conn. : F
Switch(LC4L5B2) = 000-10-0-0-000

Board 187 Board num LC4L6B1 CRATE 4 L Slot = 10

X1input1 = 1LC4L6X1 X1input2 = 1LC4L6X2
X2input1 = 2LC4L6X1 X2input2 = 2LC4L6X2
X3input1 = 3LC4L6X1 X3input2 = 3LC4L6X2
X4input1 = 4LC4L6X1 X4input2 = 4LC4L6X2

Y1input1 = 1LC4L6Y1 Y1input2 = 1LC4L6Y2
Y2input1 = 2LC4L6Y1 Y2input2 = 2LC4L6Y2
Y3input1 = 3LC4L6Y1 Y3input2 = 3LC4L6Y2
Y4input1 = 4LC4L6Y1 Y4input2 = 4LC4L6Y2

transv. conn. : M
Switch(LC4L6B1) = 000-01-1-0-000

Board 188 Board num LC4L6B2 CRATE 4 L Slot = 11

X1input1 = 1LC4L6X3 X1input2 = 1LC4L6X4
X2input1 = 2LC4L6X3 X2input2 = 2LC4L6X4
X3input1 = 3LC4L6X3 X3input2 = 3LC4L6X4
X4input1 = 4LC4L6X3 X4input2 = 4LC4L6X4

Y1input1 = NONE Y1input2 = NONE
Y2input1 = NONE Y2input2 = NONE
Y3input1 = NONE Y3input2 = NONE
Y4input1 = NONE Y4input2 = NONE

transv. conn. : F
Switch(LC4L6B2) = 000-10-0-0-000

Board 189 Board num LC4L7B1 CRATE 4 L Slot = 12

X1input1 = 1LC4L7X1 X1input2 = 1LC4L7X2
X2input1 = 2LC4L7X1 X2input2 = 2LC4L7X2
X3input1 = 3LC4L7X1 X3input2 = 3LC4L7X2
X4input1 = 4LC4L7X1 X4input2 = 4LC4L7X2

Y1input1 = 1LC4L7Y1 Y1input2 = 1LC4L7Y2
Y2input1 = 2LC4L7Y1 Y2input2 = 2LC4L7Y2
Y3input1 = 3LC4L7Y1 Y3input2 = 3LC4L7Y2
Y4input1 = 4LC4L7Y1 Y4input2 = 4LC4L7Y2

transv. conn. : M
Switch(LC4L7B1) = 000-01-1-0-000

Board 190 Board num LC4L7B2 CRATE 4 L Slot = 13

X1input1 = 1LC4L7X3 X1input2 = 1LC4L7X4
X2input1 = 2LC4L7X3 X2input2 = 2LC4L7X4
X3input1 = 3LC4L7X3 X3input2 = 3LC4L7X4
X4input1 = 4LC4L7X3 X4input2 = 4LC4L7X4

Y1input1 = NONE Y1input2 = NONE
Y2input1 = NONE Y2input2 = NONE
Y3input1 = NONE Y3input2 = NONE
Y4input1 = NONE Y4input2 = NONE

transv. conn. : F
Switch(LC4L7B2) = 001-10-0-0-000

Board 191 Board num LC4L8B1 CRATE 4 L Slot = 14

X1input1 = 1LC4L8X1 X1input2 = 1LC4L8X2
X2input1 = 2LC4L8X1 X2input2 = 2LC4L8X2
X3input1 = 3LC4L8X1 X3input2 = 3LC4L8X2
X4input1 = 4LC4L8X1 X4input2 = 4LC4L8X2

Y1input1 = 1LC4L8Y1 Y1input2 = NONE
Y2input1 = 2LC4L8Y1 Y2input2 = NONE
Y3input1 = 3LC4L8Y1 Y3input2 = NONE
Y4input1 = 4LC4L8Y1 Y4input2 = NONE

transv. conn. : M
Switch(LC4L8B1) = 011-01-1-0-000

Board 192 Board num LC4L8B2 CRATE 4 L Slot = 15

X1input1 = 1LC4L8X3 X1input2 = 1LC4L8X4
X2input1 = 2LC4L8X3 X2input2 = 2LC4L8X4
X3input1 = 3LC4L8X3 X3input2 = 3LC4L8X4
X4input1 = 4LC4L8X3 X4input2 = 4LC4L8X4

Y1input1 = NONE Y1input2 = NONE
Y2input1 = NONE Y2input2 = NONE
Y3input1 = NONE Y3input2 = NONE
Y4input1 = NONE Y4input2 = NONE

transv. conn. : F
Switch(LC4L8B2) = 111-10-0-0-000

Board 193 Board num LC4L9B1 CRATE 4 L Slot = 16

X1input1 = 1LC4L9X1 X1input2 = 1LC4L9X2
X2input1 = 2LC4L9X1 X2input2 = 2LC4L9X2
X3input1 = 3LC4L9X1 X3input2 = 3LC4L9X2
X4input1 = 4LC4L9X1 X4input2 = 4LC4L9X2

Y1input1 = 1LC4L9Y1 Y1input2 = NONE
Y2input1 = 2LC4L9Y1 Y2input2 = NONE
Y3input1 = 3LC4L9Y1 Y3input2 = NONE
Y4input1 = 4LC4L9Y1 Y4input2 = NONE

transv. conn. NONE
Switch(LC4L9B1) = 110-01-1-0-001

Board 194 Board num LC5L1B1 CRATE 5 L Slot = 1

X1input1 = 1LC5L1X1 X1input2 = 1LC5L1X2
X2input1 = 2LC5L1X1 X2input2 = 2LC5L1X2
X3input1 = 3LC5L1X1 X3input2 = 3LC5L1X2
X4input1 = 4LC5L1X1 X4input2 = 4LC5L1X2

Y1input1 = 1LC5L1Y1 Y1input2 = NONE
Y2input1 = 2LC5L1Y1 Y2input2 = NONE
Y3input1 = 3LC5L1Y1 Y3input2 = NONE
Y4input1 = 4LC5L1Y1 Y4input2 = NONE

transv. conn. NONE
Switch(LC5L1B1) = 011-10-1-0-100

Board 195 Board num LC5L2B1 CRATE 5 L Slot = 2

X1input1 = 1LC5L2X1 X1input2 = 1LC5L2X2
X2input1 = 2LC5L2X1 X2input2 = 2LC5L2X2
X3input1 = 3LC5L2X1 X3input2 = 3LC5L2X2
X4input1 = 4LC5L2X1 X4input2 = 4LC5L2X2

Y1input1 = 1LC5L2Y1 Y1input2 = NONE
Y2input1 = 2LC5L2Y1 Y2input2 = NONE
Y3input1 = 3LC5L2Y1 Y3input2 = NONE
Y4input1 = 4LC5L2Y1 Y4input2 = NONE

transv. conn. : M
Switch(LC5L2B1) = 111-01-1-0-000

Board 196 Board num LC5L2B2 CRATE 5 L Slot = 3

X1input1 = 1LC5L2X3 X1input2 = 1LC5L2X4
X2input1 = 2LC5L2X3 X2input2 = 2LC5L2X4
X3input1 = 3LC5L2X3 X3input2 = 3LC5L2X4
X4input1 = 4LC5L2X3 X4input2 = 4LC5L2X4

Y1input1 = NONE Y1input2 = NONE
Y2input1 = NONE Y2input2 = NONE
Y3input1 = NONE Y3input2 = NONE
Y4input1 = NONE Y4input2 = NONE

transv. conn. : F
Switch(LC5L2B2) = 110-10-0-0-000

Board 197 Board num LC5L3B1 CRATE 5 L Slot = 4

X1input1 = 1LC5L3X1 X1input2 = 1LC5L3X2
X2input1 = 2LC5L3X1 X2input2 = 2LC5L3X2
X3input1 = 3LC5L3X1 X3input2 = 3LC5L3X2
X4input1 = 4LC5L3X1 X4input2 = 4LC5L3X2

Y1input1 = 1LC5L3Y1 Y1input2 = 1LC5L3Y2
Y2input1 = 2LC5L3Y1 Y2input2 = 2LC5L3Y2
Y3input1 = 3LC5L3Y1 Y3input2 = 3LC5L3Y2
Y4input1 = 4LC5L3Y1 Y4input2 = 4LC5L3Y2

transv. conn. : M
Switch(LC5L3B1) = 100-01-1-0-000

Board 198 Board num LC5L3B2 CRATE 5 L Slot = 5

X1input1 = 1LC5L3X3 X1input2 = 1LC5L3X4
X2input1 = 2LC5L3X3 X2input2 = 2LC5L3X4
X3input1 = 3LC5L3X3 X3input2 = 3LC5L3X4
X4input1 = 4LC5L3X3 X4input2 = 4LC5L3X4

Y1input1 = NONE Y1input2 = NONE
Y2input1 = NONE Y2input2 = NONE
Y3input1 = NONE Y3input2 = NONE
Y4input1 = NONE Y4input2 = NONE

transv. conn. : F
Switch(LC5L3B2) = 000-10-0-0-000

Board 199 Board num LC5L4B1 CRATE 5 L Slot = 6

X1input1 = 1LC5L4X1 X1input2 = 1LC5L4X2
X2input1 = 2LC5L4X1 X2input2 = 2LC5L4X2
X3input1 = 3LC5L4X1 X3input2 = 3LC5L4X2
X4input1 = 4LC5L4X1 X4input2 = 4LC5L4X2

Y1input1 = 1LC5L4Y1 Y1input2 = 1LC5L4Y2
Y2input1 = 2LC5L4Y1 Y2input2 = 2LC5L4Y2
Y3input1 = 3LC5L4Y1 Y3input2 = 3LC5L4Y2
Y4input1 = 4LC5L4Y1 Y4input2 = 4LC5L4Y2

transv. conn. : M
Switch(LC5L4B1) = 000-01-1-0-000

Board 200 Board num LC5L4B2 CRATE 5 L Slot = 7

X1input1 = 1LC5L4X3 X1input2 = 1LC5L4X4
X2input1 = 2LC5L4X3 X2input2 = 2LC5L4X4
X3input1 = 3LC5L4X3 X3input2 = 3LC5L4X4
X4input1 = 4LC5L4X3 X4input2 = 4LC5L4X4

Y1input1 = NONE Y1input2 = NONE
Y2input1 = NONE Y2input2 = NONE
Y3input1 = NONE Y3input2 = NONE
Y4input1 = NONE Y4input2 = NONE

transv. conn. : F
Switch(LC5L4B2) = 000-10-0-0-000

Board 201 Board num LC5L5B1 CRATE 5 L Slot = 8

X1input1 = 1LC5L5X1 X1input2 = 1LC5L5X2
X2input1 = 2LC5L5X1 X2input2 = 2LC5L5X2
X3input1 = 3LC5L5X1 X3input2 = 3LC5L5X2
X4input1 = 4LC5L5X1 X4input2 = 4LC5L5X2

Y1input1 = 1LC5L5Y1 Y1input2 = 1LC5L5Y2
Y2input1 = 2LC5L5Y1 Y2input2 = 2LC5L5Y2
Y3input1 = 3LC5L5Y1 Y3input2 = 3LC5L5Y2
Y4input1 = 4LC5L5Y1 Y4input2 = 4LC5L5Y2

transv. conn. : M
Switch(LC5L5B1) = 000-01-1-0-000

Board 202 Board num LC5L5B2 CRATE 5 L Slot = 9

X1input1 = 1LC5L5X3 X1input2 = 1LC5L5X4
X2input1 = 2LC5L5X3 X2input2 = 2LC5L5X4
X3input1 = 3LC5L5X3 X3input2 = 3LC5L5X4
X4input1 = 4LC5L5X3 X4input2 = 4LC5L5X4

Y1input1 = NONE Y1input2 = NONE
Y2input1 = NONE Y2input2 = NONE
Y3input1 = NONE Y3input2 = NONE
Y4input1 = NONE Y4input2 = NONE

transv. conn. : F
Switch(LC5L5B2) = 000-10-0-0-000

Board 203 Board num LC5L6B1 CRATE 5 L Slot = 10

X1input1 = 1LC5L6X1 X1input2 = 1LC5L6X2
X2input1 = 2LC5L6X1 X2input2 = 2LC5L6X2
X3input1 = 3LC5L6X1 X3input2 = 3LC5L6X2
X4input1 = 4LC5L6X1 X4input2 = 4LC5L6X2

Y1input1 = 1LC5L6Y1 Y1input2 = 1LC5L6Y2
Y2input1 = 2LC5L6Y1 Y2input2 = 2LC5L6Y2
Y3input1 = 3LC5L6Y1 Y3input2 = 3LC5L6Y2
Y4input1 = 4LC5L6Y1 Y4input2 = 4LC5L6Y2

transv. conn. : M
Switch(LC5L6B1) = 000-01-1-0-000

Board 204 Board num LC5L6B2 CRATE 5 L Slot = 11

X1input1 = 1LC5L6X3 X1input2 = 1LC5L6X4
X2input1 = 2LC5L6X3 X2input2 = 2LC5L6X4
X3input1 = 3LC5L6X3 X3input2 = 3LC5L6X4
X4input1 = 4LC5L6X3 X4input2 = 4LC5L6X4

Y1input1 = NONE Y1input2 = NONE
Y2input1 = NONE Y2input2 = NONE
Y3input1 = NONE Y3input2 = NONE
Y4input1 = NONE Y4input2 = NONE

transv. conn. : F
Switch(LC5L6B2) = 000-10-0-0-000

Board 205 Board num LC5L7B1 CRATE 5 L Slot = 12

X1input1 = 1LC5L7X1 X1input2 = 1LC5L7X2
X2input1 = 2LC5L7X1 X2input2 = 2LC5L7X2
X3input1 = 3LC5L7X1 X3input2 = 3LC5L7X2
X4input1 = 4LC5L7X1 X4input2 = 4LC5L7X2

Y1input1 = 1LC5L7Y1 Y1input2 = 1LC5L7Y2
Y2input1 = 2LC5L7Y1 Y2input2 = 2LC5L7Y2
Y3input1 = 3LC5L7Y1 Y3input2 = 3LC5L7Y2
Y4input1 = 4LC5L7Y1 Y4input2 = 4LC5L7Y2

transv. conn. : M
Switch(LC5L7B1) = 000-01-1-0-000

Board 206 Board num LC5L7B2 CRATE 5 L Slot = 13

X1input1 = 1LC5L7X3 X1input2 = 1LC5L7X4
X2input1 = 2LC5L7X3 X2input2 = 2LC5L7X4
X3input1 = 3LC5L7X3 X3input2 = 3LC5L7X4
X4input1 = 4LC5L7X3 X4input2 = 4LC5L7X4

Y1input1 = NONE Y1input2 = NONE
Y2input1 = NONE Y2input2 = NONE
Y3input1 = NONE Y3input2 = NONE
Y4input1 = NONE Y4input2 = NONE

transv. conn. : F
Switch(LC5L7B2) = 001-10-0-0-000

Board 207 Board num LC5L8B1 CRATE 5 L Slot = 14

X1input1 = 1LC5L8X1 X1input2 = 1LC5L8X2
X2input1 = 2LC5L8X1 X2input2 = 2LC5L8X2
X3input1 = 3LC5L8X1 X3input2 = 3LC5L8X2
X4input1 = 4LC5L8X1 X4input2 = 4LC5L8X2

Y1input1 = 1LC5L8Y1 Y1input2 = NONE
Y2input1 = 2LC5L8Y1 Y2input2 = NONE
Y3input1 = 3LC5L8Y1 Y3input2 = NONE
Y4input1 = 4LC5L8Y1 Y4input2 = NONE

transv. conn. : M
Switch(LC5L8B1) = 011-01-1-0-000

Board 208 Board num LC5L8B2 CRATE 5 L Slot = 15

X1input1 = 1LC5L8X3 X1input2 = 1LC5L8X4
X2input1 = 2LC5L8X3 X2input2 = 2LC5L8X4
X3input1 = 3LC5L8X3 X3input2 = 3LC5L8X4
X4input1 = 4LC5L8X3 X4input2 = 4LC5L8X4

Y1input1 = NONE Y1input2 = NONE
Y2input1 = NONE Y2input2 = NONE
Y3input1 = NONE Y3input2 = NONE
Y4input1 = NONE Y4input2 = NONE

transv. conn. : F
Switch(LC5L8B2) = 111-10-0-0-000

Board 209 Board num LC5L9B1 CRATE 5 L Slot = 16

X1input1 = 1LC5L9X1 X1input2 = 1LC5L9X2
X2input1 = 2LC5L9X1 X2input2 = 2LC5L9X2
X3input1 = 3LC5L9X1 X3input2 = 3LC5L9X2
X4input1 = 4LC5L9X1 X4input2 = 4LC5L9X2

Y1input1 = 1LC5L9Y1 Y1input2 = NONE
Y2input1 = 2LC5L9Y1 Y2input2 = NONE
Y3input1 = 3LC5L9Y1 Y3input2 = NONE
Y4input1 = 4LC5L9Y1 Y4input2 = NONE

transv. conn. NONE
Switch(LC5L9B1) = 110-01-1-0-001

Board 210 Board num LC6L1B1 CRATE 6 L Slot = 1

X1input1 = 1LC6L1X1 X1input2 = 1LC6L1X2
X2input1 = 2LC6L1X1 X2input2 = 2LC6L1X2
X3input1 = 3LC6L1X1 X3input2 = 3LC6L1X2
X4input1 = 4LC6L1X1 X4input2 = 4LC6L1X2

Y1input1 = 1LC6L1Y1 Y1input2 = NONE
Y2input1 = 2LC6L1Y1 Y2input2 = NONE
Y3input1 = 3LC6L1Y1 Y3input2 = NONE
Y4input1 = 4LC6L1Y1 Y4input2 = NONE

transv. conn. NONE
Switch(LC6L1B1) = 011-10-1-0-100

Board 211 Board num LC6L2B1 CRATE 6 L Slot = 2

X1input1 = 1LC6L2X1 X1input2 = 1LC6L2X2
X2input1 = 2LC6L2X1 X2input2 = 2LC6L2X2
X3input1 = 3LC6L2X1 X3input2 = 3LC6L2X2
X4input1 = 4LC6L2X1 X4input2 = 4LC6L2X2

Y1input1 = 1LC6L2Y1 Y1input2 = NONE
Y2input1 = 2LC6L2Y1 Y2input2 = NONE
Y3input1 = 3LC6L2Y1 Y3input2 = NONE
Y4input1 = 4LC6L2Y1 Y4input2 = NONE

transv. conn. : M
Switch(LC6L2B1) = 111-01-1-0-000

Board 212 Board num LC6L2B2 CRATE 6 L Slot = 3

X1input1 = 1LC6L2X3 X1input2 = 1LC6L2X4
X2input1 = 2LC6L2X3 X2input2 = 2LC6L2X4
X3input1 = 3LC6L2X3 X3input2 = 3LC6L2X4
X4input1 = 4LC6L2X3 X4input2 = 4LC6L2X4

Y1input1 = NONE Y1input2 = NONE
Y2input1 = NONE Y2input2 = NONE
Y3input1 = NONE Y3input2 = NONE
Y4input1 = NONE Y4input2 = NONE

transv. conn. : F
Switch(LC6L2B2) = 111-10-0-0-000

Board 213 Board num LC6L3B1 CRATE 6 L Slot = 4

X1input1 = 1LC6L3X1 X1input2 = 1LC6L3X2
X2input1 = 2LC6L3X1 X2input2 = 2LC6L3X2
X3input1 = 3LC6L3X1 X3input2 = 3LC6L3X2
X4input1 = 4LC6L3X1 X4input2 = 4LC6L3X2

Y1input1 = 1LC6L3Y1 Y1input2 = NONE
Y2input1 = 2LC6L3Y1 Y2input2 = NONE
Y3input1 = 3LC6L3Y1 Y3input2 = NONE
Y4input1 = 4LC6L3Y1 Y4input2 = NONE

transv. conn. : M
Switch(LC6L3B1) = 111-01-1-0-000

Board 214 Board num LC6L3B2 CRATE 6 L Slot = 5

X1input1 = 1LC6L3X3 X1input2 = 1LC6L3X4
X2input1 = 2LC6L3X3 X2input2 = 2LC6L3X4
X3input1 = 3LC6L3X3 X3input2 = 3LC6L3X4
X4input1 = 4LC6L3X3 X4input2 = 4LC6L3X4

Y1input1 = NONE Y1input2 = NONE
Y2input1 = NONE Y2input2 = NONE
Y3input1 = NONE Y3input2 = NONE
Y4input1 = NONE Y4input2 = NONE

transv. conn. : F
Switch(LC6L3B2) = 111-10-0-0-000

Board 215 Board num LC6L4B1 CRATE 6 L Slot = 6

X1input1 = 1LC6L4X1 X1input2 = 1LC6L4X2
X2input1 = 2LC6L4X1 X2input2 = 2LC6L4X2
X3input1 = 3LC6L4X1 X3input2 = 3LC6L4X2
X4input1 = 4LC6L4X1 X4input2 = 4LC6L4X2

Y1input1 = 1LC6L4Y1 Y1input2 = NONE
Y2input1 = 2LC6L4Y1 Y2input2 = NONE
Y3input1 = 3LC6L4Y1 Y3input2 = NONE
Y4input1 = 4LC6L4Y1 Y4input2 = NONE

transv. conn. : M
Switch(LC6L4B1) = 111-01-1-0-000

Board 216 Board num LC6L4B2 CRATE 6 L Slot = 7

X1input1 = 1LC6L4X3 X1input2 = 1LC6L4X4
X2input1 = 2LC6L4X3 X2input2 = 2LC6L4X4
X3input1 = 3LC6L4X3 X3input2 = 3LC6L4X4
X4input1 = 4LC6L4X3 X4input2 = 4LC6L4X4

Y1input1 = NONE Y1input2 = NONE
Y2input1 = NONE Y2input2 = NONE
Y3input1 = NONE Y3input2 = NONE
Y4input1 = NONE Y4input2 = NONE

transv. conn. : F
Switch(LC6L4B2) = 111-10-0-0-000

Board 217 Board num LC6L5B1 CRATE 6 L Slot = 8

X1input1 = 1LC6L5X1 X1input2 = 1LC6L5X2
X2input1 = 2LC6L5X1 X2input2 = 2LC6L5X2
X3input1 = 3LC6L5X1 X3input2 = 3LC6L5X2
X4input1 = 4LC6L5X1 X4input2 = 4LC6L5X2

Y1input1 = 1LC6L5Y1 Y1input2 = NONE
Y2input1 = 2LC6L5Y1 Y2input2 = NONE
Y3input1 = 3LC6L5Y1 Y3input2 = NONE
Y4input1 = 4LC6L5Y1 Y4input2 = NONE

transv. conn. : M
Switch(LC6L5B1) = 111-01-1-0-000

Board 218 Board num LC6L5B2 CRATE 6 L Slot = 9

X1input1 = 1LC6L5X3 X1input2 = 1LC6L5X4
X2input1 = 2LC6L5X3 X2input2 = 2LC6L5X4
X3input1 = 3LC6L5X3 X3input2 = 3LC6L5X4
X4input1 = 4LC6L5X3 X4input2 = 4LC6L5X4

Y1input1 = NONE Y1input2 = NONE
Y2input1 = NONE Y2input2 = NONE
Y3input1 = NONE Y3input2 = NONE
Y4input1 = NONE Y4input2 = NONE

transv. conn. : F
Switch(LC6L5B2) = 111-10-0-0-000

Board 219 Board num LC6L6B1 CRATE 6 L Slot = 10

X1input1 = 1LC6L6X1 X1input2 = 1LC6L6X2
X2input1 = 2LC6L6X1 X2input2 = 2LC6L6X2
X3input1 = 3LC6L6X1 X3input2 = 3LC6L6X2
X4input1 = 4LC6L6X1 X4input2 = 4LC6L6X2

Y1input1 = 1LC6L6Y1 Y1input2 = NONE
Y2input1 = 2LC6L6Y1 Y2input2 = NONE
Y3input1 = 3LC6L6Y1 Y3input2 = NONE
Y4input1 = 4LC6L6Y1 Y4input2 = NONE

transv. conn. : M
Switch(LC6L6B1) = 111-01-1-0-000

Board 220 Board num LC6L6B2 CRATE 6 L Slot = 11

X1input1 = 1LC6L6X3 X1input2 = 1LC6L6X4
X2input1 = 2LC6L6X3 X2input2 = 2LC6L6X4
X3input1 = 3LC6L6X3 X3input2 = 3LC6L6X4
X4input1 = 4LC6L6X3 X4input2 = 4LC6L6X4

Y1input1 = NONE Y1input2 = NONE
Y2input1 = NONE Y2input2 = NONE
Y3input1 = NONE Y3input2 = NONE
Y4input1 = NONE Y4input2 = NONE

transv. conn. : F
Switch(LC6L6B2) = 111-10-0-0-000

Board 221 Board num LC6L7B1 CRATE 6 L Slot = 12

X1input1 = 1LC6L7X1 X1input2 = 1LC6L7X2
X2input1 = 2LC6L7X1 X2input2 = 2LC6L7X2
X3input1 = 3LC6L7X1 X3input2 = 3LC6L7X2
X4input1 = 4LC6L7X1 X4input2 = 4LC6L7X2

Y1input1 = 1LC6L7Y1 Y1input2 = NONE
Y2input1 = 2LC6L7Y1 Y2input2 = NONE
Y3input1 = 3LC6L7Y1 Y3input2 = NONE
Y4input1 = 4LC6L7Y1 Y4input2 = NONE

transv. conn. : M
Switch(LC6L7B1) = 111-01-1-0-000

Board 222 Board num LC6L7B2 CRATE 6 L Slot = 13

X1input1 = 1LC6L7X3 X1input2 = 1LC6L7X4
X2input1 = 2LC6L7X3 X2input2 = 2LC6L7X4
X3input1 = 3LC6L7X3 X3input2 = 3LC6L7X4
X4input1 = 4LC6L7X3 X4input2 = 4LC6L7X4

Y1input1 = NONE Y1input2 = NONE
Y2input1 = NONE Y2input2 = NONE
Y3input1 = NONE Y3input2 = NONE
Y4input1 = NONE Y4input2 = NONE

transv. conn. : F
Switch(LC6L7B2) = 111-10-0-0-000

Board 223 Board num LC6L8B1 CRATE 6 L Slot = 14

X1input1 = 1LC6L8X1 X1input2 = 1LC6L8X2
X2input1 = 2LC6L8X1 X2input2 = 2LC6L8X2
X3input1 = 3LC6L8X1 X3input2 = 3LC6L8X2
X4input1 = 4LC6L8X1 X4input2 = 4LC6L8X2

Y1input1 = 1LC6L8Y1 Y1input2 = NONE
Y2input1 = 2LC6L8Y1 Y2input2 = NONE
Y3input1 = 3LC6L8Y1 Y3input2 = NONE
Y4input1 = 4LC6L8Y1 Y4input2 = NONE

transv. conn. : M
Switch(LC6L8B1) = 111-01-1-0-000

Board 224 Board num LC6L8B2 CRATE 6 L Slot = 15

X1input1 = 1LC6L8X3 X1input2 = 1LC6L8X4
X2input1 = 2LC6L8X3 X2input2 = 2LC6L8X4
X3input1 = 3LC6L8X3 X3input2 = 3LC6L8X4
X4input1 = 4LC6L8X3 X4input2 = 4LC6L8X4

Y1input1 = NONE Y1input2 = NONE
Y2input1 = NONE Y2input2 = NONE
Y3input1 = NONE Y3input2 = NONE
Y4input1 = NONE Y4input2 = NONE

transv. conn. : F
Switch(LC6L8B2) = 111-10-0-0-000

Board 225 Board num LC6L9B1 CRATE 6 L Slot = 16

X1input1 = 1LC6L9X1 X1input2 = 1LC6L9X2
X2input1 = 2LC6L9X1 X2input2 = 2LC6L9X2
X3input1 = 3LC6L9X1 X3input2 = 3LC6L9X2
X4input1 = 4LC6L9X1 X4input2 = 4LC6L9X2

Y1input1 = 1LC6L9Y1 Y1input2 = NONE
Y2input1 = 2LC6L9Y1 Y2input2 = NONE
Y3input1 = 3LC6L9Y1 Y3input2 = NONE
Y4input1 = 4LC6L9Y1 Y4input2 = NONE

transv. conn. NONE
Switch(LC6L9B1) = 110-01-1-0-001

Board 226 Board num LC7L1B1 CRATE 7 L Slot = 1

X1input1 = 1LC7L1X1 X1input2 = 1LC7L1X2
X2input1 = 2LC7L1X1 X2input2 = 2LC7L1X2
X3input1 = 3LC7L1X1 X3input2 = 3LC7L1X2
X4input1 = 4LC7L1X1 X4input2 = 4LC7L1X2

Y1input1 = 1LC7L1Y1 Y1input2 = 1LC7L1Y2
Y2input1 = 2LC7L1Y1 Y2input2 = 2LC7L1Y2
Y3input1 = 3LC7L1Y1 Y3input2 = 3LC7L1Y2
Y4input1 = 4LC7L1Y1 Y4input2 = 4LC7L1Y2

transv. conn. NONE
Switch(LC7L1B1) = 000-10-1-0-100

Board 227 Board num LC7L2B1 CRATE 7 L Slot = 2

X1input1 = 1LC7L2X1 X1input2 = 1LC7L2X2
X2input1 = 2LC7L2X1 X2input2 = 2LC7L2X2
X3input1 = 3LC7L2X1 X3input2 = 3LC7L2X2
X4input1 = 4LC7L2X1 X4input2 = 4LC7L2X2

Y1input1 = 1LC7L2Y1 Y1input2 = 1LC7L2Y2
Y2input1 = 2LC7L2Y1 Y2input2 = 2LC7L2Y2
Y3input1 = 3LC7L2Y1 Y3input2 = 3LC7L2Y2
Y4input1 = 4LC7L2Y1 Y4input2 = 4LC7L2Y2

transv. conn. NONE
Switch(LC7L2B1) = 000-11-1-0-000

Board 228 Board num LC7L3B1 CRATE 7 L Slot = 3

X1input1 = 1LC7L3X1 X1input2 = 1LC7L3X2
X2input1 = 2LC7L3X1 X2input2 = 2LC7L3X2
X3input1 = 3LC7L3X1 X3input2 = 3LC7L3X2
X4input1 = 4LC7L3X1 X4input2 = 4LC7L3X2

Y1input1 = 1LC7L3Y1 Y1input2 = 1LC7L3Y2
Y2input1 = 2LC7L3Y1 Y2input2 = 2LC7L3Y2
Y3input1 = 3LC7L3Y1 Y3input2 = 3LC7L3Y2
Y4input1 = 4LC7L3Y1 Y4input2 = 4LC7L3Y2

transv. conn. NONE
Switch(LC7L3B1) = 000-11-1-0-000

Board 229 Board num LC7L4B1 CRATE 7 L Slot = 4

X1input1 = 1LC7L4X1 X1input2 = 1LC7L4X2
X2input1 = 2LC7L4X1 X2input2 = 2LC7L4X2
X3input1 = 3LC7L4X1 X3input2 = 3LC7L4X2
X4input1 = 4LC7L4X1 X4input2 = 4LC7L4X2

Y1input1 = 1LC7L4Y1 Y1input2 = 1LC7L4Y2
Y2input1 = 2LC7L4Y1 Y2input2 = 2LC7L4Y2
Y3input1 = 3LC7L4Y1 Y3input2 = 3LC7L4Y2
Y4input1 = 4LC7L4Y1 Y4input2 = 4LC7L4Y2

transv. conn. NONE
Switch(LC7L4B1) = 000-11-1-0-000

Board 230 Board num LC7L5B1 CRATE 7 L Slot = 5

X1input1 = 1LC7L5X1 X1input2 = 1LC7L5X2
X2input1 = 2LC7L5X1 X2input2 = 2LC7L5X2
X3input1 = 3LC7L5X1 X3input2 = 3LC7L5X2
X4input1 = 4LC7L5X1 X4input2 = 4LC7L5X2

Y1input1 = 1LC7L5Y1 Y1input2 = 1LC7L5Y2
Y2input1 = 2LC7L5Y1 Y2input2 = 2LC7L5Y2
Y3input1 = 3LC7L5Y1 Y3input2 = 3LC7L5Y2
Y4input1 = 4LC7L5Y1 Y4input2 = 4LC7L5Y2

transv. conn. NONE
Switch(LC7L5B1) = 000-11-1-0-000

Board 231 Board num LC7L6B1 CRATE 7 L Slot = 6

X1input1 = 1LC7L6X1 X1input2 = 1LC7L6X2
X2input1 = 2LC7L6X1 X2input2 = 2LC7L6X2
X3input1 = 3LC7L6X1 X3input2 = 3LC7L6X2
X4input1 = 4LC7L6X1 X4input2 = 4LC7L6X2

Y1input1 = 1LC7L6Y1 Y1input2 = 1LC7L6Y2
Y2input1 = 2LC7L6Y1 Y2input2 = 2LC7L6Y2
Y3input1 = 3LC7L6Y1 Y3input2 = 3LC7L6Y2
Y4input1 = 4LC7L6Y1 Y4input2 = 4LC7L6Y2

transv. conn. NONE
Switch(LC7L6B1) = 000-11-1-0-000

Board 232 Board num LC7L7B1 CRATE 7 L Slot = 7

X1input1 = 1LC7L7X1 X1input2 = 1LC7L7X2
X2input1 = 2LC7L7X1 X2input2 = 2LC7L7X2
X3input1 = 3LC7L7X1 X3input2 = 3LC7L7X2
X4input1 = 4LC7L7X1 X4input2 = 4LC7L7X2

Y1input1 = 1LC7L7Y1 Y1input2 = 1LC7L7Y2
Y2input1 = 2LC7L7Y1 Y2input2 = 2LC7L7Y2
Y3input1 = 3LC7L7Y1 Y3input2 = 3LC7L7Y2
Y4input1 = 4LC7L7Y1 Y4input2 = 4LC7L7Y2

transv. conn. NONE
Switch(LC7L7B1) = 000-11-1-0-000

Board 233 Board num LC7L8B1 CRATE 7 L Slot = 8

X1input1 = 1LC7L8X1 X1input2 = 1LC7L8X2
X2input1 = 2LC7L8X1 X2input2 = 2LC7L8X2
X3input1 = 3LC7L8X1 X3input2 = 3LC7L8X2
X4input1 = 4LC7L8X1 X4input2 = 4LC7L8X2

Y1input1 = 1LC7L8Y1 Y1input2 = 1LC7L8Y2
Y2input1 = 2LC7L8Y1 Y2input2 = 2LC7L8Y2
Y3input1 = 3LC7L8Y1 Y3input2 = 3LC7L8Y2
Y4input1 = 4LC7L8Y1 Y4input2 = 4LC7L8Y2

transv. conn. NONE
Switch(LC7L8B1) = 000-11-1-0-000

Board 234 Board num LC7L9B1 CRATE 7 L Slot = 9

X1input1 = 1LC7L9X1 X1input2 = 1LC7L9X2
X2input1 = 2LC7L9X1 X2input2 = 2LC7L9X2
X3input1 = 3LC7L9X1 X3input2 = 3LC7L9X2
X4input1 = 4LC7L9X1 X4input2 = 4LC7L9X2

Y1input1 = 1LC7L9Y1 Y1input2 = 1LC7L9Y2
Y2input1 = 2LC7L9Y1 Y2input2 = 2LC7L9Y2
Y3input1 = 3LC7L9Y1 Y3input2 = 3LC7L9Y2
Y4input1 = 4LC7L9Y1 Y4input2 = 4LC7L9Y2

transv. conn. NONE
Switch(LC7L9B1) = 000-01-1-0-001

MAIN REMARKS DURING THE REVIEW AND PROPOSED SOLUTIONS :

1- About system overview: only one output for "single muon" to CTP is presently foreseen (see Figure 2-1), at the level of the Global trigger board, with a remote choice of the Pt cut (above high or low Pt, same Pt cuts as for the dimuon outputs).

3 outputs will be finally implemented on the Global board: "single muon" above low Pt cut, "single muon" above high Pt cut and a remotely chosen "single muon" output above low or high Pt cut.

2- About Local trigger board linked by transverse connectors: it is advised to mechanically link the front panels of the Local boards which are interconnected by transverse connectors.

It will be done.

3- About Local board switches: it is advised to implement means to verify the switch setting through the DaQ.

Implemented in the final version of the Local board, see paragraph 5.2.2 and Table 5.2.

4- About inventory number: it is needed to have a visible (and a computer readable) inventory number, following ALICE naming conventions, on each board.

A visible inventory number will be put on the front face of each Local board. It is not possible at this level of the project to implement a computer readable number.

5- About front panel LED: it is suggested to equip the front panel of the Local board with LED indicating that the board is responding "normally".

The Local boards will be equipped with 3 LEDs. A LED signaling a VME access, two LEDs for a valid trigger X and trigger Y on output (before the LUT).

6- About price quotation for halogen free PCBs in the tender.

It will be done but it already seems that this is still very unusual in industry. The delays for delivery could be unacceptable.

7- About indicating that the power supplies of the VME crates are not standard.

It will be done.

8- About the importance of testing a full crate before the complete production.

It is already in our plans (see section 9.1).

9- About cabling, density of cables at the crates.

It is a clear concern for us. We foresee to build a mockup to study adequate cable supports to solve this question.

10- About resetting, when needed, the FPGAs with a dedicated signal rather than making a ON/OFF of the crate by the DCS system.

Implemented in the final version of the Local board. The /sysreset pin of the J1 bus is used. The FPGA reset will be sent via the JTAG run-ctrl.

11- About tests of the whole system, documentation of the test protocol and long term test.

The details of the test protocol of the whole system has still to be written, together with the group of Subatech Nantes who will provide the global test bench. A global test of the system is scheduled between Mars 05 and January 06 (see section 9.1).

ERRATA :