



HAL
open science

Recent results on prototype aerogel threshold counters for particle identification in the region 0.5-4.3 GeV/c

K. Arisaka, E. Borsato, D. Boutigny, A. Buzykaev, F. Dalcorso, I. de Bonis, J. Favier, F. Ferroni, M. Foucher, S F. Ganzhur, et al.

► To cite this version:

K. Arisaka, E. Borsato, D. Boutigny, A. Buzykaev, F. Dalcorso, et al.. Recent results on prototype aerogel threshold counters for particle identification in the region 0.5-4.3 GeV/c. International Conference on Instrumentation for Experiments at e+e- Colliders 6, Feb 1996, Novosibirsk, Russia. pp.460-464. in2p3-00014466

HAL Id: in2p3-00014466

<https://in2p3.hal.science/in2p3-00014466v1>

Submitted on 8 Nov 2013

HAL is a multi-disciplinary open access archive for the deposit and dissemination of scientific research documents, whether they are published or not. The documents may come from teaching and research institutions in France or abroad, or from public or private research centers.

L'archive ouverte pluridisciplinaire **HAL**, est destinée au dépôt et à la diffusion de documents scientifiques de niveau recherche, publiés ou non, émanant des établissements d'enseignement et de recherche français ou étrangers, des laboratoires publics ou privés.



Recent Results on Prototype Aerogel Threshold
Counters for Particle Identification in the Region:
0.5 - 4.3 GeV/c

K. Arisaka¹, E. Borsato², D. Boutigny³, A. Buzykaev⁴,
F. DalCorso², I. De Bonis³, J. Favier³, F. Ferroni⁵,
M. Foucher⁶, S. Ganzhur⁴, F. Iacovella², H. Jawahery⁶,
Y. Karyotakis³, G. Kolachev⁴, E. Kravchenko⁴, R. Lafaye³,
M.A. Mazzoni⁵, V. Mikerov⁴, M. Morandin², S. Morganti⁵,
A. Onuchin⁴, J. Oyang⁷, G. Piredda⁵, M. Posocco²,
R. Santacesaria⁵, A. Shamov⁴, R. Stroili², V. Taurisky⁴,
V. Telnov⁴, E. Torassa², C. Voci²

Presented by D. Boutigny at

*"VI International Conference on Instrumentation for Experiments at e^+e^-
Colliders" Novosibirsk, March 1996.*

E-mail: boutigny@lapp.in2p3.fr

Abstract

The recent development of new processes has lead to the fabrication of small density silica aerogel with high optical quality. The BaBar experiment, in order to achieve its physics program, requires a good pion/kaon identification capability up to 4.3 GeV/c able to work inside a 1.5 Tesla magnetic field. An aerogel threshold counter using the combination of 2 refractive indices (1.055 and 1.007) can be used to complete the angular coverage of the particle identification system in the forward region. Different detector geometries read out by two photo-detectors types (fine mesh phototubes and Hybrid Photo-Diodes) have been considered and tested in CERN beam test.

¹ University of California, Los Angeles, Los Angeles, USA

² Università di Padova and INFN, Sezione di Padova, Italy.

³ L.A.P.P. CNRS/IN2P3 - Annecy-le-Vieux France

⁴ Budker Institute of Nuclear Physics, Novosibirsk, Russia

⁵ Università di Roma "La Sapienza" and INFN, Sezione di Roma 1, Italy

⁶ University of Maryland, College Park, Maryland, USA

⁷ California Institute of Technology, Pasadena, California, USA

30 May 1996

1 Introduction

The main physics goal of the BaBar experiment [1] is the measurement of the CP violation parameters in the B sector. In order to measure the α angle of the unitarity triangle one must be able to distinguish the decay $B^0 \rightarrow \pi^+\pi^-$ from $B^0 \rightarrow K^+\pi^-$. The momentum of these pions or kaons is of the order of 4 GeV/c in the forward region. To measure the time dependent CP violation asymmetry, one should determine the nature of the B meson emitted in the opposite direction to the one decaying in a CP eigenstate. This tagging can be performed using decays with a single kaon and measuring its sign. In this case, the kaon momentum is mostly below 1.5 GeV/c.

The particle identification in this momentum region (0.5 - 4.3 GeV/c) can be performed using the combination of 2 aerogel counters with indices equal to 1.055 and 1.007.

Two geometrical designs covering the forward region of the BaBar detector have been considered:

- The first one, is a 2-layer, 2 ring design. In each ring, there is one layer of high index ($n=1.055$) aerogel and one layer of low index ($n=1.007$) aerogel readout either by Hamamatsu fine mesh phototubes (FM) (1.5" for the high index and 2" for the low index), or by Hybrid-Photo-Diodes (HPD). These photo-detectors are connected to the aerogel containers with a pyramidal shaped air light guide located on the top and on the bottom of the rings. The aerogel containers are wrapped with multiple layers of high reflectivity PTFE film.
- The second design consists in 2 super-layers, each one with two counters with low and high aerogel indices. The second super-layer is shifted with respect to the first one, in order to prevent loss of signal when a particle crosses the photo-tube window in one of the layers. The aerogel blocks are placed inside cells wrapped with multiple layers of high reflectivity PTFE film. Each high (low) index cell is read out by 2 (3) 2" Hamamatsu fine mesh phototubes.

Prototypes corresponding to the different design have been tested in a cern beam line [2] [3] [4].

2 Description of the beam line and apparatus

The prototypes have been tested in the PS T10 beam line at CERN. This beam could provide positive and negative particles with momenta between

1 and 5 GeV/c. The beam components were mainly pions and protons. The

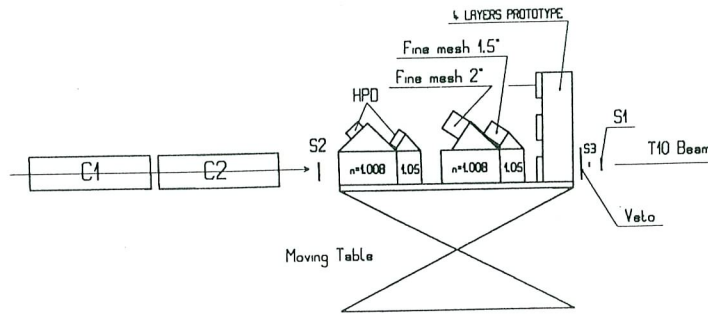

Fig. 1. The T10 beam line with the apparatus

beam line was equipped with 2 CO₂ Cherenkov counters filled at a 4.3 bar pressure. The beam was defined by the coincidence of 3 scintillation counter signals, its extension being limited by the third counter ($1 \times 1 \text{ cm}^2$). Another thick (1 cm) veto scintillator counter was read out in a CAMAC scaler in order to count the number of particles crossing the setup in a $1 \mu\text{sec}$ gate. The three prototypes were placed on a moving table (figure 1). The 2-layer prototype was composed of 2 separated cells:

- The low index cell, had a dimension of $10 \times 10 \times 14 \text{ cm}^3$. It was filled with 5 aerogel slices of $9.5 \times 9.5 \text{ cm}^2$ front face and 2.6 cm thick. The aerogel has been produced by the Jet Propulsion Laboratory (JPL), and had a nominal index of 1.008. The light was read out either with a 2", 19 stage, Hamamatsu R5504 fine mesh photomultiplier tube, or by two 1", Hybrid Photo-Diodes.
- The high index cell, had a dimension of $10 \times 10 \times 6 \text{ cm}^3$. Two sets of aerogel blocks have been tested, one from Airglass with an index $n = 1.055$ and another from the Borskov Catalysis Institute in Novosibirsk with an index $n = 1.050$. The counter was read out either with a 1.5", 16 stage Hamamatsu R6148 fine mesh photomultiplier tube, or by one 1" HPD.

The photo-detectors were connected to the cells with a pyramidal shaped air light guide. The walls of the cells and of the light guide were wrapped with multiple layers of high reflectivity $250 \mu\text{m}$ PTFE film on top of aluminized mylar.

The 4-layer prototype with low index aerogel is shown in figure 2, the walls were wrapped with three layers of $250 \mu\text{m}$ PTFE film. The counter was filled with 69 mm thick aerogel with 1.012 refractive index. It was readout with three 2" fine mesh photo-tubes.

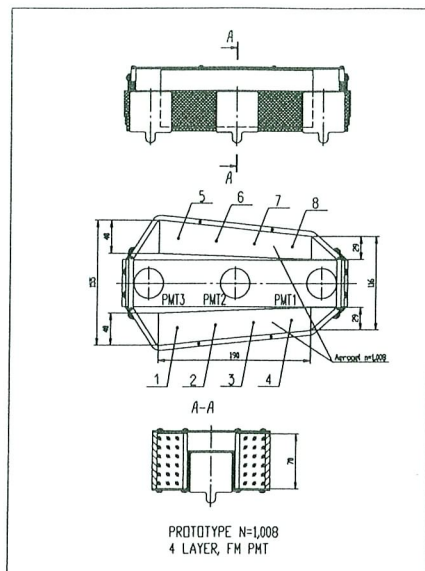

Fig. 2. The 4-layer, low index prototype.

3 Calibration of the photodetectors

Due to the mesh structure, fine mesh phototubes do not permit to resolve the single photo-electron peak. In order to calibrate this device we injected in the cell, with an optical fiber, the light of an LED tuned such that $\simeq 95\%$ of the triggers result in "0" photo-electron (p.e.) detected (pedestal). A typical spectrum is shown in figure 3 (left). The calibration is deduced from the mean value of the signal distribution outside the pedestal region. There is some contribution of the single photo-electron below the pedestal which should be estimated, this is the main source of error on the calibration ($\simeq 5\%$).

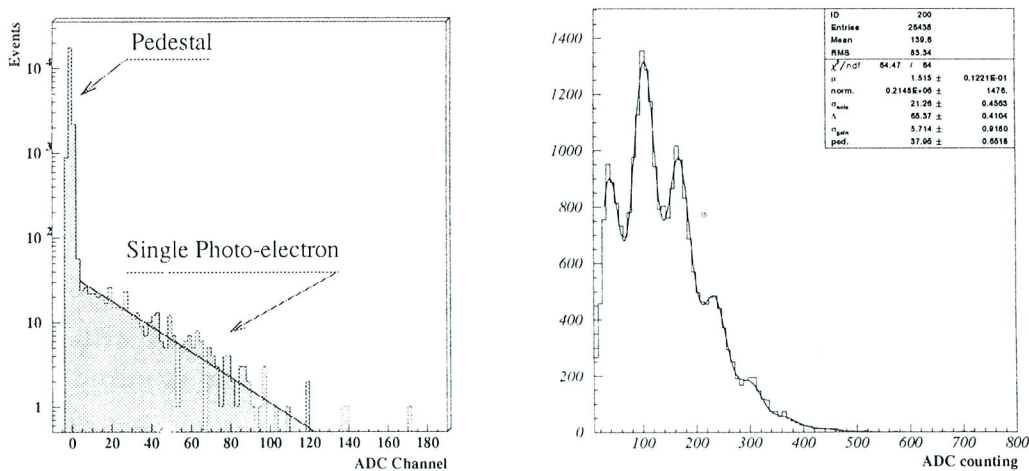

Fig. 3. Left: Fine mesh response in the single photo-electron regime. Right: HPD response for $\simeq 1.5$ photo-electrons detected in average

With its excellent resolution, the HPD is able to resolve the single and the

multi photo-electron peaks. The calibration is easier than for the fine mesh phototubes. Figure 3 (right) shows a typical spectrum obtained with an LED tuned in order to get $\simeq 1.5$ p.e. detected in average. The spectrum is fitted with a Poisson distribution convoluted with a gaussian, the calibration constant is deduced from the separation between two consecutive peaks. The error on calibration is $\simeq 1\%$.

4 Results on low index aerogel

4.1 Response to $\beta = 1$ particles

The low index aerogel prototypes were exposed to a 5 GeV/c negative pion beam ($\beta \simeq 1$). The events were selected by requiring a clean signal in both gas Cherenkov counters, and by asking only 1 count within 1 μ sec in the veto counter to reduce pile up events.

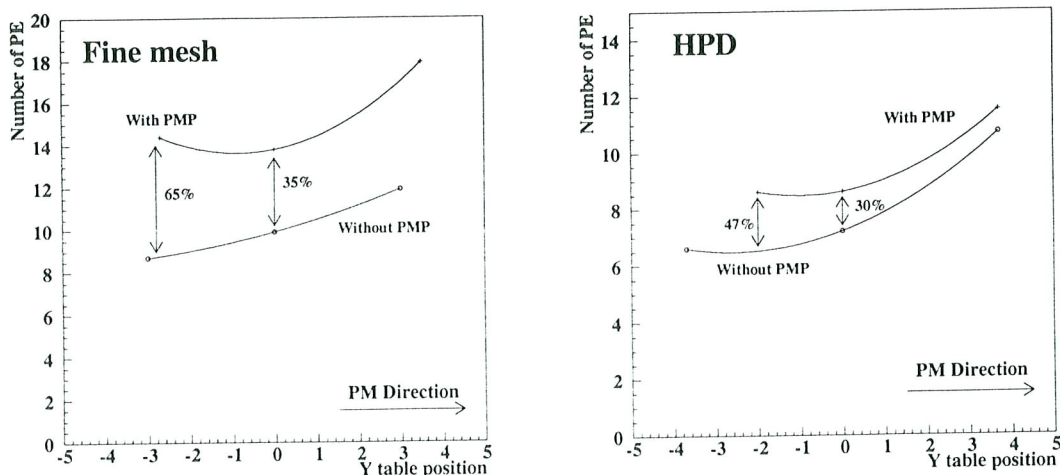

Fig. 4. Average number of photo-electrons versus the vertical distance to the center of the box for the 2-layer prototype with fine mesh (left) and HPD (right) readout

Figure 4 (left) shows the observed average number of photo-electrons as a function of the vertical distance (y) to the center of the cell for the 2-layer prototype ($n=1.008$) with fine mesh phototube readout. The light guide entrance was placed on top of the box at $y=5$ cm. The lower curve correspond a standard wrapping with multiple layers of PTFE while, for the upper curve, we have added one extra layer of PTFE impregnated with PMP 420 wavelength shifter [5]. One can see that with PMP we gain 35% of the light in the middle of the cell, and 65% at $y=-3$ cm. The wavelength shift from $\simeq 350$ nm to $\simeq 420$ nm has the obvious advantage to decrease both the absorption and the Rayleigh scattering which is responsible for increasing the photon path

length. This effect is naturally enhanced when the crossing particle is close to a shifting wall.

Figure 4 (right) shows the result of the same scan for the 2-layer prototype with HPD readout. In both cases (fine mesh or HPD) we do not observe a strong dependence of the signal with the position of the incident beam in the horizontal plane ($< 5\%$ for a 2 cm displacement)

Figure 5 shows the result of a scan in the vertical plane for the 4-layer prototype. The aerogel used in this case had an index of refraction $n=1.012$, the 3 curves: N1, N2 and N3 are the number of photo-electrons detected by the 3 fine mesh phototubes, the sum: NSUM of the 3 signals is uniform with an average number of photo-electrons equal to 11.4

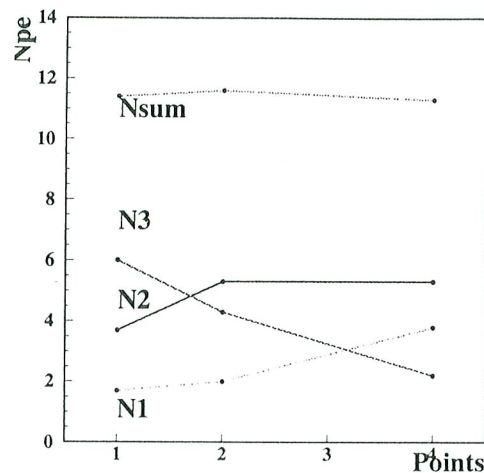

Fig. 5. Number of photo-electrons for different impact point on the 4-layer prototype, the aerogel refractive index is 1.012. The impact points correspond to the positions indicated on figure 2

4.2 Background from below threshold particles

We have studied the signal induced by below threshold particles. For this purpose, we have used a 5 GeV/c proton beam selected by asking the absence of signal in both gas Cherenkov counters and by cutting events giving more than 1 count in the veto counter. The following table summarizes the measured background in the different conditions. The first column indicates the prototype, the second the background, and the third the corresponding number of photo-electrons for a $\beta = 1$ particle. As the aerogel used for the 4-layer option has an index of 1.012, we indicate in parenthesis the estimated numbers for $n=1.008$.

Prototype	Background (p.e)	Response for $\beta = 1$ (p.e)
2-layer fine mesh	0.9	13.4
2-layer HPD	0.6	8.6
4-layer	0.5 (0.3)	11.4 (7.8)

The background is coming mainly from Cherenkov light in PTFE and δ rays in the aerogel.

Figure 6 shows the proton contamination: ($\mathcal{P}(p \rightarrow \pi)$) and the pion inefficiency: ($\mathcal{P}(\pi \rightarrow p)$) as a function of the cut applied on the number of photo-electrons to decide if an event corresponds to a pion or a proton. The upper

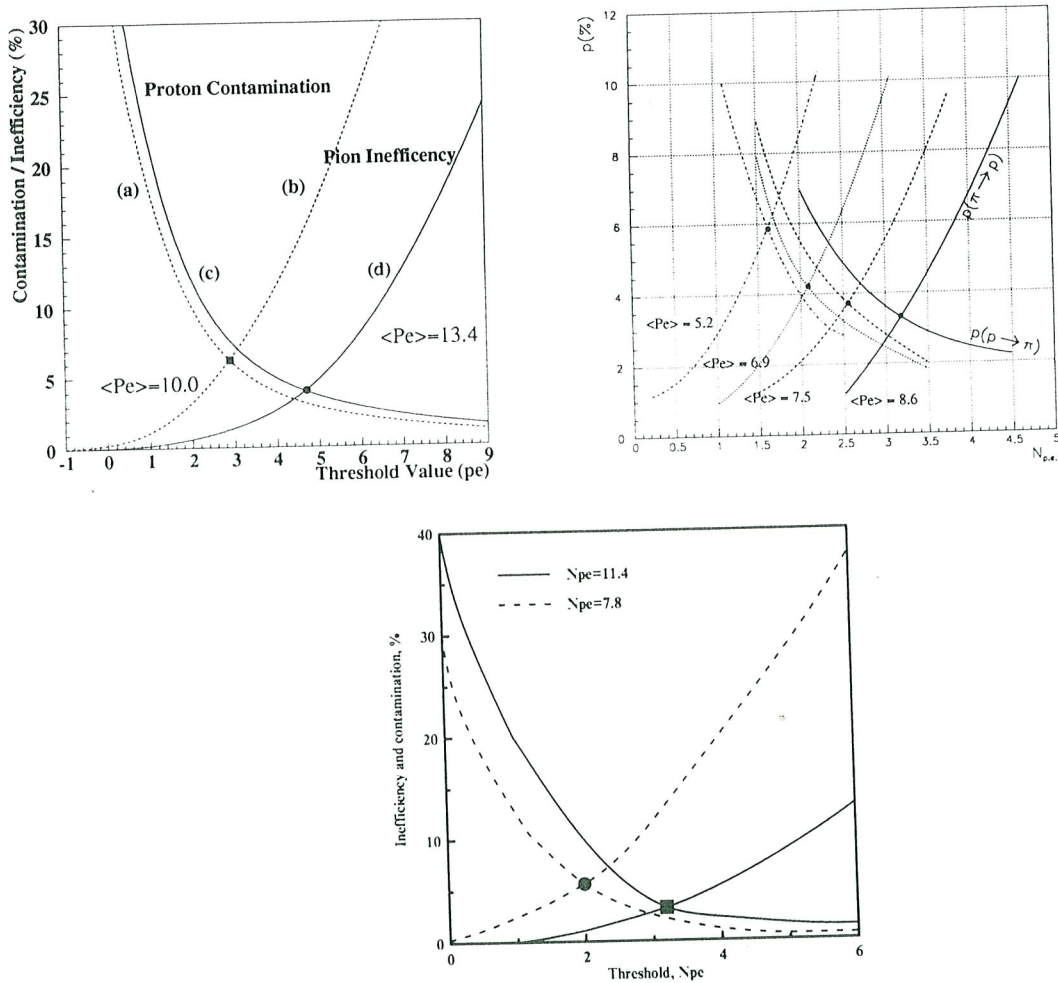

Fig. 6. $\mathcal{P}(\pi \rightarrow P)$ and $\mathcal{P}(P \rightarrow \pi)$ as a function of the threshold in photo-electrons for the 3 prototypes. The different curves on each figures correspond to configuration with different average number of photo-electrons for $\beta = 1$ particles.

left figure corresponds to the 2-layer option with fine mesh phototube readout, the upper right to the 2-layer option with HPD readout and the lower one, to the 4-layer option. For the 4-layer option, as the aerogel used had an index of 1.012, the response for $n=1.008$ is estimated by summing 2 phototubes over the 3. $\mathcal{P}(p \rightarrow \pi)$ is the probability for a proton to give light in the counter and to be identified as a pion and $\mathcal{P}(\pi \rightarrow p)$ is the probability for a pion, not to give enough light in the counter and to be identified as a proton. The point for which those two probabilities are equal is considered as a figure of merit of our detector and permits us to compare different configurations. One can remark that with the 4-layer option, it is possible to set a low threshold on each phototube, and to cut on the number of phototubes with a signal above threshold to decide whether a particle has given light or not.

5 Results on the high index aerogel

Figure 7 shows the average number of photo-electrons as a function of the vertical distance (y) to the center of the cell for the 2-layer option with fine mesh phototube readout. The lower curve correspond to $n=1.055$ aerogel from Airglass and the higher one to $n=1.050$ aerogel from Novosibirsk. One can see that the Novosibirsk aerogel gives more light than the Airglass one. The table below summarize the minimum observed number of photo-electrons for the 3 different prototypes with the Novosibirsk aerogel.

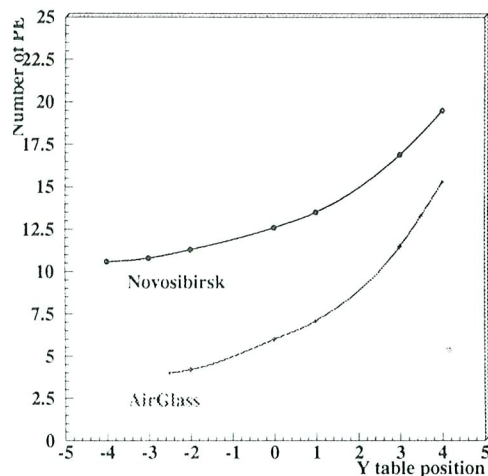

Fig. 7. Average number of photo-electrons versus the vertical distance to the center of the cell for the 2-layer prototype with fine mesh phototube reading

Prototype	2-layer fine mesh	2-layer HPD	4-layer
Number of Pe	10	9.7	11

A study with 1 GeV/c proton performed with the 2-layer high index prototype with HPD readout shows that the background is $\simeq 0.20$ p.e. and that one can get a proton contamination of 2.0% for a pion efficiency equal to 98%.

6 Conclusion

We have tested 3 compact aerogel threshold counter prototypes with 2 indices, all prototypes provide enough photo-electrons for $\beta = 1$ particles with a low background, to be used as a powerful particle identification detector.

The new HPD tubes proved to be a reliable photo-detector.

The PMP 420 wavelength shifter increases substantially the light collection efficiency.

There is still some room for improvement with the new fine mesh phototubes, which have an increased effective photocathode diameter and a higher mesh density.

References

- [1] D. Boutigny et al., BaBar Technical Design Report, SLAC-R-95-457, March 1995.
- [2] BaBar Aerogel Group, "Performances of a prototype aerogel counter read out by fine mesh phototubes" BaBar note 289.
- [3] BaBar Aerogel Group, "Performances of an aerogel threshold particle identification detector read out by Hybrid Photon Detectors" BaBar note 291.
- [4] BaBar Aerogel Group, "Prototype performance of a 4-layer aerogel Cherenkov detector" BaBar note 290.
- [5] C. D'Ambrosio et al., Organic scintillators with large Stokes shifts dissolved in polystyrene NIM A 307 (1991) 430-435 and references there in.