



**HAL**  
open science

# The $1^+ \rightarrow n^+$ charge breeding method for the production of radioactive and stable continuous/pulsed multi-charged ion beams

N. Chauvin, J.F. Bruandet, J.L. Bouly, J.C. Curdy, R. Geller, T. Lamy, P. Sole, P. Sortais, J.L. Vieux-Rochaz

## ► To cite this version:

N. Chauvin, J.F. Bruandet, J.L. Bouly, J.C. Curdy, R. Geller, et al.. The  $1^+ \rightarrow n^+$  charge breeding method for the production of radioactive and stable continuous/pulsed multi-charged ion beams. International Workshop on ECR Sources 14, May 1999, Geneva, Switzerland. pp.151-154. in2p3-00006011

**HAL Id: in2p3-00006011**

**<https://hal.in2p3.fr/in2p3-00006011>**

Submitted on 7 Sep 2000

**HAL** is a multi-disciplinary open access archive for the deposit and dissemination of scientific research documents, whether they are published or not. The documents may come from teaching and research institutions in France or abroad, or from public or private research centers.

L'archive ouverte pluridisciplinaire **HAL**, est destinée au dépôt et à la diffusion de documents scientifiques de niveau recherche, publiés ou non, émanant des établissements d'enseignement et de recherche français ou étrangers, des laboratoires publics ou privés.

# The $1^+ \rightarrow n^+$ charge breeding method for the production of radioactive and stable continuous/pulsed multi-charged ion beams.

N. Chauvin, J.F. Bruandet, J.L. Bouly, J.C. Curdy, R. Geller,  
T. Lamy, P.Sole, P. Sortais, J.L. Vieux-Rochaz

*Institut des Sciences Nucléaires UJF-IN2P3-CNRS, 53 Av. des Martyrs 38026 GRENOBLE cedex*

## Abstract

The principle of the  $1^+ \rightarrow n^+$  charge breeding method by injecting a mono-charged ion beam in an Electron Cyclotron Resonance Ion Source is recalled.

Some  $1^+ \rightarrow n^+$  breeding efficiencies in continuous mode are given, like 9% for  $\text{Ar}^{1+} \rightarrow \text{Ar}^{8+}$  and 5% for  $\text{Rb}^{1+} \rightarrow \text{Rb}^{15+}$ . The global capture efficiency is deduced from the whole charge state distribution spectrum.

The ECRIT (ECR Ion Trap) mode that allows to produce a pulsed multi-charged beam is explained. The  $n^+$  ions are extracted in a 20 ms pulse. The breeding-bunching efficiencies are measured for  $\text{Rb}^{1+} \rightarrow \text{Rb}^{15+}$  (2.2%) and  $\text{Pb}^{1+} \rightarrow \text{Pb}^{22+}$  (1.3%). Ion trapping time in the ECRIT plasma is evaluated to some hundreds of ms.

A new application of the  $1^+ \rightarrow n^+$  method is developed: the production of multi-charged natural metallic ions. First experiments have been done on uranium: a 500 nA continuous current of  $\text{U}^{26+}$  has been measured.

Finally, the future developments on the  $1^+ \rightarrow n^+$  experiment are discussed. A description of a  $1^+ \rightarrow n^+$  dedicated high performance ECRIS named PHOENIX (Production Hautement Optimisée Electrons de Noyaux Ionisés et de rayons X) will be presented.

## 1 Introduction

Radioactive mono-charged ions can be produced, for example, by bombardment of a target with a primary beam. They have to be multi-ionized in order to produce Radioactive Ion Beams (RIB) with an energy of a few MeV by nuclei.

So, a charge state increase of the radioactive ions have to be done with the best possible efficiency (i.e. a few %).

The principle of the  $1^+ \rightarrow n^+$  method is to capture radioactive elements by the plasma of an ECRIS [1], which is suitable to get high charge state and an optimal beam intensity.

A low-energy (about 20 keV) mono-charged stable ion beam is produced by a  $1^+$  source, simulating the production source. The  $1^+$  ions are transported for several meters in a low energy beam line and are injected into a MINIMAFIOS 10 GHz ECRIS [2].

The  $1^+$  ions are electrostatically decelerated inside the source, the energy is adjusted so they can cross the plasma potential and are thermalized by ion-ion collisions. When the velocity of the incoming ions is of the same order as the average velocity of the plasma ions, they are captured and multi-ionized step by step by collisions with the electrons of the plasma. Finally, the  $n^+$  ions are extracted and accelerated.

## 2 The continuous mode

The  $1^+$  breeding efficiency is given by:

$$\eta = \frac{1}{n} \frac{I_{n^+}}{I_{1^+}}$$

where  $I_{1^+}$  and  $I_{n^+}$  represent respectively the intensities of the mono-charged and multi-charged ion beams.

The total breeding efficiency is given by:

$$\eta_G = \sum_{i=1}^N \eta_i$$

where  $\eta_i$  is the efficiency for each charge state  $i$  extracted from the ECR source (for a given element) and  $N$  the higher charge state produced.

Experiments have been performed on several elements: rare gases, alkali, metallic [3, 4] and non-metallic. The results are given in table 1.

Element	$1^+ \rightarrow n^+$	$\eta$	$\eta_G$
$^{84}\text{Kr}$	$\text{Kr}^{1+} \rightarrow \text{Kr}^{11+}$	11 %	40 %
$^{40}\text{Ar}$	$\text{Ar}^{1+} \rightarrow \text{Ar}^{8+}$	9 %	40 %
$^{85}\text{Rb}$	$\text{Rb}^{1+} \rightarrow \text{Rb}^{15+}$	5.5 %	35 %
$^{208}\text{Pb}$	$\text{Pb}^{1+} \rightarrow \text{Pb}^{22+}$	4.5 %	35 %
$^{64}\text{Zn}$	$\text{Zn}^{1+} \rightarrow \text{Zn}^{9+}$	3.5 %	23 %
$^{56}\text{Cr}$	$\text{Cr}^{1+} \rightarrow \text{Cr}^{11+}$	3.5 %	21 %
$^{32}\text{S}$	$\text{S}^{1+} \rightarrow \text{S}^{7+}$	2.5 %	11 %

Table 1:  $1^+ \rightarrow n^+$  breeding efficiencies for various elements.

A lead charge state distribution (CSD) spectrum is shown Figure 1. The injected  $\text{Pb}^{1+}$  beam has an intensity of 210 nA. The most abundant charge extracted from the MINIMAFIOS source is  $\text{Pb}^{22+}$ .

With rare gases like argon, the global breeding efficiency is about 40%. In standard operation when argon gas is injected in MINIMAFIOS, we measured a global efficiency of 43% [3].

These very good results can be explained by the fact that rare gases don't stick to the wall of the plasma

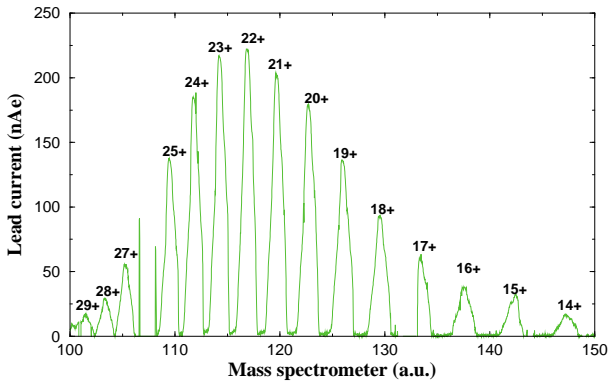

Figure 1: *CSD for lead in MINIMAFIOS. Injected beam : 220 nA of  $Pb^{1+}$ .*

chamber. When the  $1^+$  beam is electrostatically decelerated, ions which hit the walls are neutralized and then can be captured by the ECR plasma and multi-ionized.

On the contrary, ions from condensable elements (metal, alkali) stick to the walls when hitting them. So these ions are definitively lost for the  $1^+ \rightarrow n^+$  process. In that case, the  $1^+$  ions have to be directly captured by the plasma. That's why breeding efficiencies for condensable elements are not as good as rare gases.

The characteristics of the injected beam have an influence on the ion capture by the ECR plasma and consequently on the breeding efficiency. This particular point is discussed in a companion paper [5] in this workshop.

### 3 The ECRIT mode

Since most of the RIB are generated in a quasi-continuous manner, a pulsed multi-charged ion beam would be of a great interest for pulsed accelerators like synchrotron or pulsed LINAC. In order to lose as few particles as possible we have to transform a DC  $1^+$  ion beam into an  $n^+$  ion bunch. That's why we developed the Electron Cyclotrons Resonance Ion Trap (ECRIT) system [6].

#### 3.1 The ECRIT principle

First, let us recall that the tuning of an ECRIS, in order to obtain decent beam intensities, requires a compromise between ion confinement and ion extraction. The higher the ion confinement, the higher charge state obtained (because of the step-by-step ionisation process in an ECR plasma). On the opposite, the lower the ion confinement, the higher beam intensity extracted. This compromise is not applied in the ECRIS mode.

The ECRIT mode consists in optimizing the trapping of the  $1^+$  ions independently of the extracted ion current. During the trapping time, the ions are multi-ionized and are trapped too. They are therefore ready

to be extracted in a pulse using the so-called afterglow process [7].

#### 3.2 Experimental procedure

A  $1^+$  ion beam of intensity  $I$  is injected in the ECRIT in a pulsed mode during the time  $t_{inj}$ . The RF power, which is also pulsed, is canceled after a  $\Delta t$  time following the end of the  $1^+$  pulse. During  $\Delta t$  the  $1^+$  ions are multi-ionized and trapped in the plasma and they are brutally extracted by the cancellation of the RF power (see Figure 2).

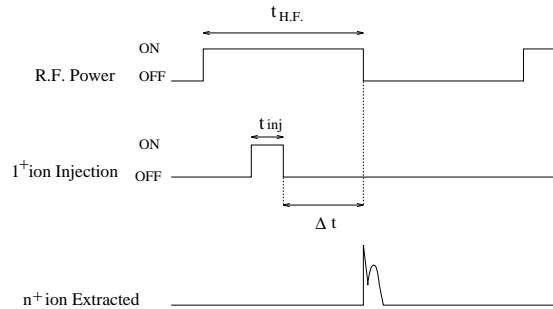

Figure 2: *Temporal structure of the R.F. power,  $1^+$  ions and  $n^+$  ions extracted.*

#### 3.3 Trapping Time of the ECRIT

In order to evaluate the confinement time, we inject in the ECRIT  $Pb^{1+}$  pulses with  $\Delta t = 0$  ms and with several  $t_{inj}$ . For each  $t_{inj}$ , the number of extracted  $Pb^{22+}$  ions is measured (see experimental points on Figure 3).

Let us assume that the time to reach the charge states equilibrium ( $\sim 30$  ms) is significantly shorter than the confinement time ( $> 300$  ms). So we will consider that the  $Pb^{1+}$  ions injected in the ECRIT (and captured by the plasma) are almost instantaneously transformed to  $Pb^{22+}$ .

So, the evolution of the number of  $Pb^{22+}$  ions in the plasma, as a function of the time between the beginning of the  $Pb^{1+}$  injection and the afterglow ( $n_{Pb^{22+}}(t)$ ), is given by the equation:

$$\frac{dn_{Pb^{22+}}(t)}{dt} = -\frac{n_{Pb^{22+}}(t)}{\tau_{conf}} + \alpha, \quad (1)$$

where  $\tau_{conf}$  is the  $Pb^{22+}$  confinement time and  $\alpha$  the number of  $Pb^{1+}$  captured per second by the ECRIT plasma. So, we can consider that  $\alpha$  is equal to the number of  $Pb^{1+}$  injected per second in the ECRIT by the  $Pb^{1+} \rightarrow Pb^{22+}$  breeding efficiency in continuous mode,  $\eta_{Pb^{1+} \rightarrow Pb^{22+}}$ .

The number of  $Pb^{22+}$  ions extracted is therefore:

$$n_{Pb^{22+} \text{ ext}} = \alpha \beta \tau_{conf} (1 - e^{-\frac{t}{\tau_{conf}}}), \quad (2)$$

where  $\beta$  is an experimentally determined constant.

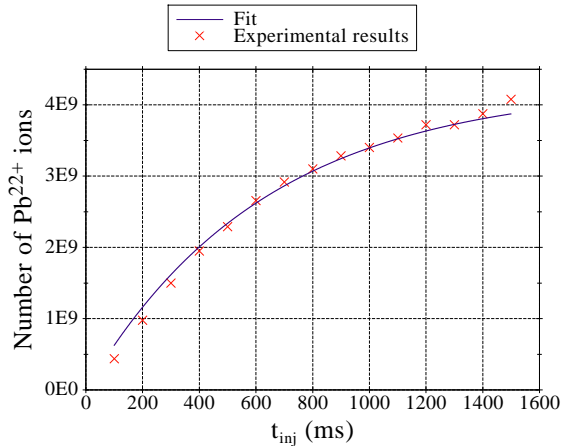

Figure 3:  $Pb^{22+}$  confinement time of 630 ms.

We finally have:

$$n_{Pb^{22+}ext} = 6.8 \times 10^9 \tau_{conf} (1 - e^{-\frac{t}{\tau_{conf}}}). \quad (3)$$

A very good fit between the experimental values and Eq.3 is obtained with an average confinement time of  $\tau_{conf} = 630$  ms (see Figure 3).

### 3.4 Charge capacity of the ECRIT

The charge capacity was evaluated with the  $1^+ \rightarrow n^+$  rubidium bunching. The  $Rb^{1+}$  ions (intensity of  $Rb^{1+}$  beam: 400 nA) and the RF power are injected in the ECRIT with the same frequency and the same phase (i.e.  $t_{H.F.} = t_{inj} = 1000$  ms and  $\Delta t=0$ ). The  $Rb^{15+}$  afterglow signal measured has a maximum peak intensity of  $11.5 \mu A$  (see Figure 4). During 20 ms following the R.F. power cancellation  $2.4 \times 10^{10}$  particles of  $Rb^{15+}$  are extracted, corresponding to a total number of Rb ions extracted higher than  $10^{11}$  for the whole charge spectrum.

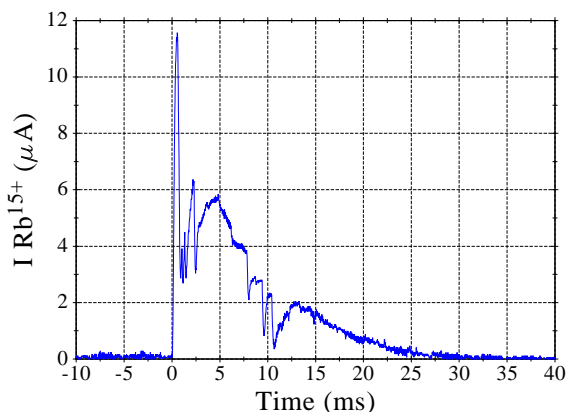

Figure 4: An  $Rb^{15+}$  peak current of  $11.5 \mu A$  is extracted for 400 nA of  $Rb^{1+}$  injected.

### 3.5 Efficiency of the ECRIT

In order to have the best  $1^+ \rightarrow n^+$  efficiency in ECRIT mode, the termination of the  $1^+$  injection has to coincide with the R.F. power cancellation (i.e.  $\Delta t = 0$  ms). To perform the efficiency measurements,  $t_{inj}$  must be shorter than the confinement time: in that way, the loss of the  $n^+$  particles is reduced to a minimum. However we have to mention that the efficiency slightly decreases with the increasing injected ion current.

For the Rb, the  $1^+$  beam we injected for efficiency measurements had an intensity of 130 nA. The integration of the afterglow signal for 20 ms after the RF cancellation gives a  $Rb^{1+} \rightarrow Rb^{15+}$  transformation efficiency of 2.2%.

The injection of a 90 nA  $Pb^{1+}$  ion beam leads to a  $Pb^{1+} \rightarrow Pb^{22+}$  efficiency of 1.3%.

## 4 Production of multi-charged stable metallic ion beams.

### 4.1 Principle

One can imagine a new application for the  $1^+ \rightarrow n^+$  charge breeding method: the production of high current of natural multi-charged metallic ions. For example, in a standard ECRIS mode, the most convenient way to produce  $U^{n+}$  ion beams is to inject  $UF_6$  gas in the source. To obtain high charge state and reasonable currents, the gas pressure in the source is a fundamental parameter. The lower the pressure, the higher charge states reached. On the other way, the more gas injected, the higher beam intensities extracted.

The principle, with  $1^+ \rightarrow n^+$ , is to uncorrelate the production process and the multi-ionisation process. The  $1^+$  source is fed with  $UF_6$  gas and can work at high pressure, in order to produce an intense beam of  $U^{1+}$ . Then, this beam is injected in the  $n^+$  source operated at low pressure. So, the  $1^+$  ions are captured and are efficiently multi-ionized.

### 4.2 First results

Very preliminary experiments have been performed to produce  $U^{n+}$ . The " $1^+$ " source we use is NANO-GAN which delivers a  $8 \mu A U^{5+}$  beam. Even when working with a few watts of R.F. power, NANOGAN produced multi-charged ions. An ECRIS like MICRO-GAN which can produce high current of  $1^+$  beam would probably be a better choice in this case. But we checked that the  $1^+ \rightarrow n^+$  process with the injection of a  $5^+$  beam is quite the same as a  $1^+$  beam injection.

We extracted from MINIMAFIOS a  $U^{25+}$  stable ion beam intensity 510 enA. The uranium CSD is shown Figure 5. One could notice that, in this mode, the breeding efficiency is about 1.2%.

This first result shows the feasibility of using  $1^+ \rightarrow n^+$  to produce high currents of metallic ions.

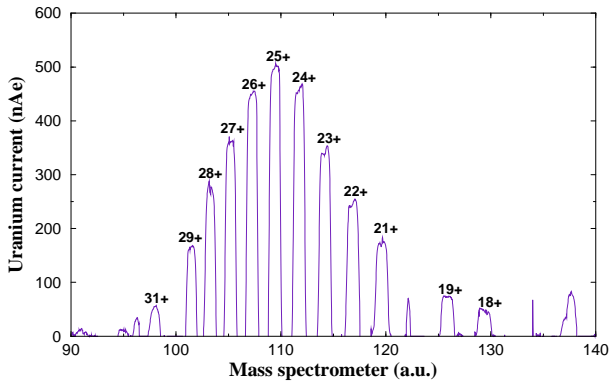

Figure 5: CSD of uranium with MINIMAFIOS.

## 5 A $1^+ \rightarrow n^+$ dedicated source: PHOENIX booster

The results presented in the previous sections are limited by the 15 years old MINIMAFIOS source. Now, we are building a  $1^+ \rightarrow n^+$  dedicated high performances ECRIS: PHOENIX booster (see Figure 6).

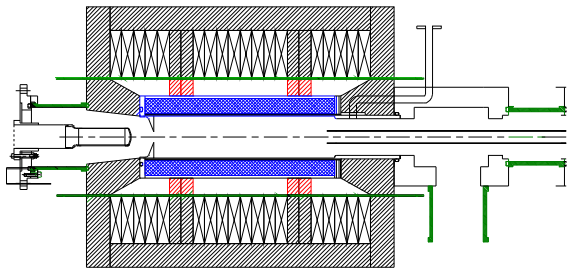

Figure 6: The PHOENIX booster source.

This new source will have several advantages: a conception well adapted for the R&D studies, a good high voltage insulation to work at 60 kV, an hexapole of 1.1 T (which can be easily changed for an octupole) that allows to inject R.F. power from 10 to 18 GHz, a modular axial magnetic field as shown in Figure 7.

With PHOENIX we will first optimize the capture of the  $1^+$  ions by the plasma. Experiments could be done on the beam injection and deceleration in the source.

Since PHOENIX will be a high-performance source, the charge density would be significantly higher than in MINIMAFIOS. Higher currents or higher charge states would be reached.

The ECRIT mode will also be importantly improved. The ion trapping in the plasma would be optimized and the peak current extracted would be higher since the time structure of the  $n^+$  pulses would be reduced by a 3 or 4 factor.

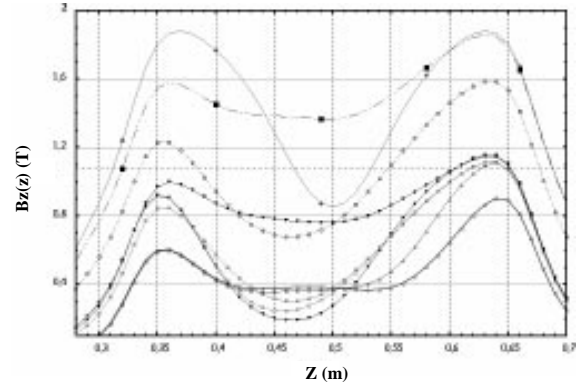

Figure 7: Magnetic axial inductions  $B(z)$  reliable with PHOENIX.

In conclusion, PHOENIX is designed to be an operational on-line source as an injector for a RIB accelerator.

## References

- [1] J.-L. BELMONT ET AL. - The PIAFE projet at Grenoble. In: *Proceedings of the International Workshop on the Physics and Techniques of Secondary Nuclear Beam*, éd. by B. Fernandez J.F.Bruandet et M.Bex. (Editions Frontières). - Dourdan, March 1992.
- [2] C. TAMBURELLA. - *Projet P.I.A.F.E. : Production d'Etats de Charges Elevées pour des Ions Radioactifs*. - PhD thesis, Université Denis Diderot Paris VII, 1996.
- [3] T. LAMY ET AL. - Production of multicharged radioactive ion beams : New results for the  $1^+ \rightarrow n^+$  method with the MINIMAFIOS and SARA-CAPRICE electron cyclotron resonance ion sources. *Rev. Sci. Instrum.*, vol. 69, n° 3, March 1998, pp. 1322-1326.
- [4] T. LAMY ET AL. - Ion Charge Increase  $1^+ \rightarrow n^+$  for the acceleration of alkali and metallic radioactive ions. In: *Proceedings of the EPAC 98*. - Stockholm, June 1998.
- [5] T. LAMY ET AL. - Characteristics of the injected beam in the E.C.R. charge breeder  $1^+ \rightarrow n^+$ . In *these proceedings*, May 1999.
- [6] N. CHAUVIN ET AL. - Electron Cyclotron Resonance Ion Trap, a multicharged ion breeder/buncher. *Nucl. Instrum. Methods A*, vol. 419, n° 1, 1998, pp. 185-188.
- [7] P. SORTAIS. - Pulsed ECR ion source using the afterglow mode. *Rev. Sci. Instrum.*, vol. 63, n° 4, April 1992, pp. 2801-2085.